

MHSC Series



MHSC series is designed for low profile type with low DCR and ultra large current, especially for height limited boards. Its molded magnetic shielded type is suitable for high-density mounting and ultra low buzz noise. Soldering conditions can be easily confirmed when mounting onto board. This series also provides customers with embossed carrier type packaging for automatic mounting machine.

Features

- RoHS compliant
- Ultra low profile on board
- Shielded construction
- Ultra low buzz noise due to molding construction

Applications

- High density DC/DC converter in height limited board
- POL converters
- High current VRM/VDR for notebook / server / desktop CPU
- High current DC/DC converter in distributed power system
- High speed charger

Product Identification

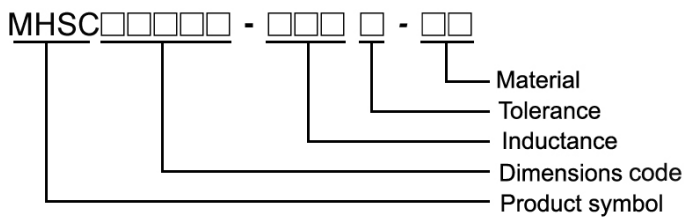

Shape and Dimensions

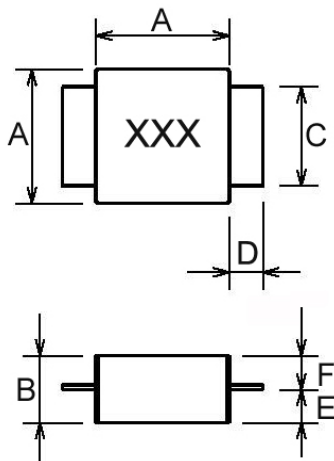

Dimensions in mm

TYPE	A	B	C	D	E	F
04020	4.2±0.2	2.0 ^{+0.2} _{-0.3}	1.5±0.2	1.2±0.3	1.2	1.0
06022	6.6±0.2	2.2 ^{+0.2} _{-0.3}	3.0±0.2	1.5±0.3	1.4	1.0
06036	6.6±0.2	3.6 ^{+0.2} _{-0.3}	3.0±0.2	1.5±0.3	2.3	1.5
08036	8.0±0.2	3.6 ^{+0.2} _{-0.3}	6.0±0.2	2.0±0.3	2.3	1.3±0.2

Recommended Pattern

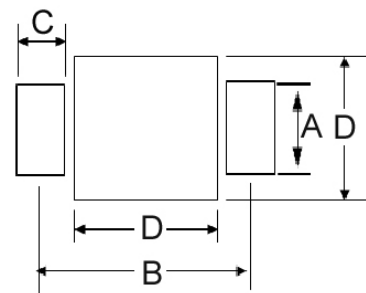

Dimensions in mm

TYPE	A	B	C	D
04020	2.0	6.5	1.8	4.5
06022	3.5	9.5	2.2	6.9
06036	3.5	9.5	2.2	6.9
08036	6.0	11.9	3.0	8.4

Electrical Characteristics

Part Number	Inductance (μH)	Tolerance ($\pm\%$)	Test Frequency (KHz)	I _{rms} (A)Typ.	I _{sat} (A)Typ.	RDC ($\text{m}\Omega$)Max
MHSC04020-R33M-R8	0.33	20	100	8.5	16	10
MHSC04020-R47M-R8	0.47	20	100	8	14	11

- I_{rms} DC current (A) that will cause an approximate ΔT of 40°C
- I_{sat} DC current (A) that will cause L to drop approximately 30%
- Tolerance : M= $\pm 20\%$
- L : WK 3260B, 100KHz 0.5V
- R_{dc} : CHEN HWA 502
- Operating temperature range from -55°C to 125°C . (Including self - temperature rise)

Test Instruments : WK3260B Impedance / Material Analyzer

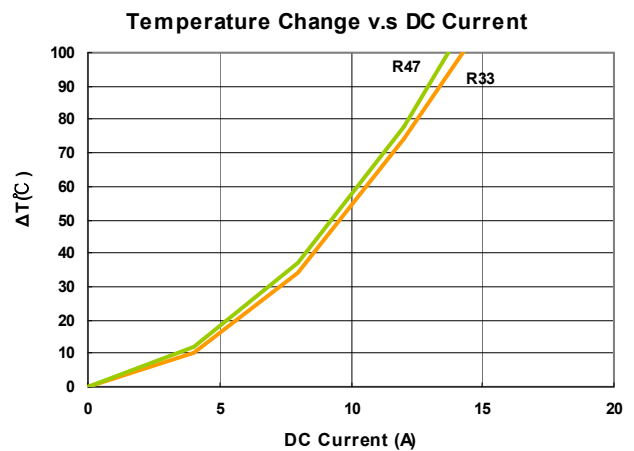
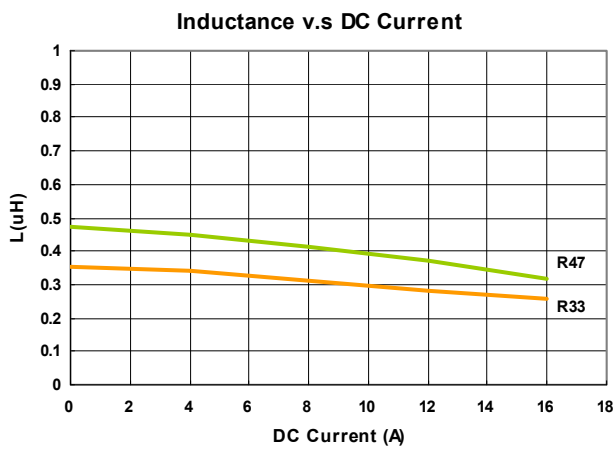

Electrical Characteristics

Part Number	Inductance (μH)	Tolerance ($\pm\%$)	Test Frequency (KHz)	I _{rms} (A)Typ.	I _{sat} (A)Typ.	RDC ($\text{m}\Omega$)Max
MHSC06022-R22M-R8	0.22	20	100	18	28	6
MHSC06022-R82M-R8	0.82	20	100	9.5	18	13.8
MHSC06022-1R0M-R8	1.0	20	100	9	16	15.4
MHSC06022-2R2M-R8	2.2	20	100	6	10.5	29.8

- I_{rms} DC current (A) that will cause an approximate ΔT of 40°C
- I_{sat} DC current (A) that will cause L to drop approximately 30%
- Tolerance : M= $\pm 20\%$
- L : WK 3260B, 100KHz 0.5V
- R_{dc} : CHEN HWA 502
- Operating temperature range from -55°C to 125°C . (Including self - temperature rise)

Test Instruments : WK3260B Impedance / Material Analyzer

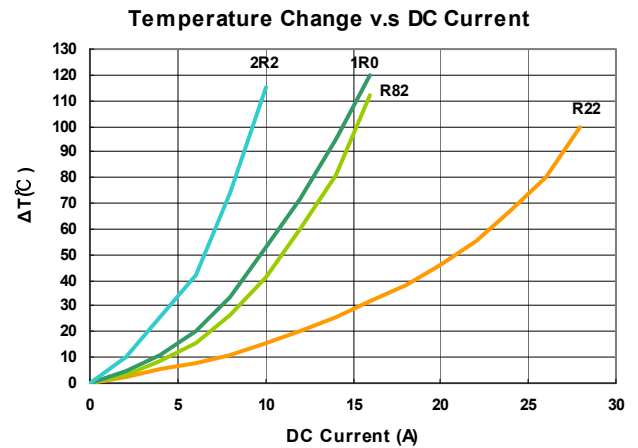
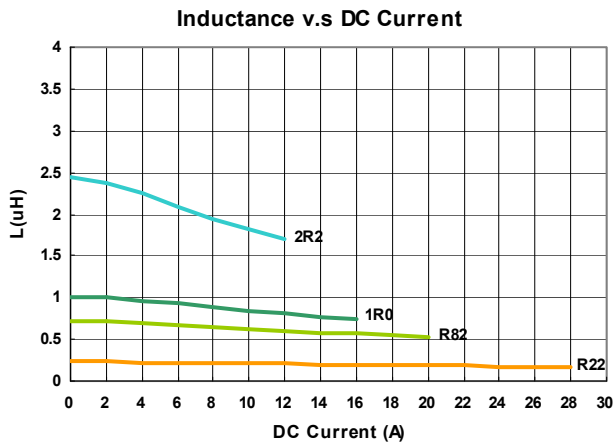

Electrical Characteristics

Part Number	Inductance (μH)	Tolerance ($\pm\%$)	Test Frequency (KHz)	I _{rms} (A)Typ.	I _{sat} (A)Typ.	RDC ($\text{m}\Omega$)Max
MHSC06036-R82M-R8	0.82	20	100	14	20	6.8
MHSC06036-1R0M-R8	1.0	20	100	12	19	8.2
MHSC06036-2R2M-R8	2.2	20	100	9.5	14	14.5
MHSC06036-6R8M-R8	6.8	20	100	5.5	7	44.5
MHSC06036-100M-R8	10	20	100	4.5	6.5	66

- I_{rms} DC current (A) that will cause an approximate ΔT of 40°C
- I_{sat} DC current (A) that will cause L to drop approximately 30%
- Tolerance : M= $\pm 20\%$
- L : WK 3260B, 100KHz 0.5V
- Rdc : CHEN HWA 502
- Operating temperature range from -55°C to 125°C . (Including self - temperature rise)

Test Instruments : WK3260B Impedance / Material Analyzer

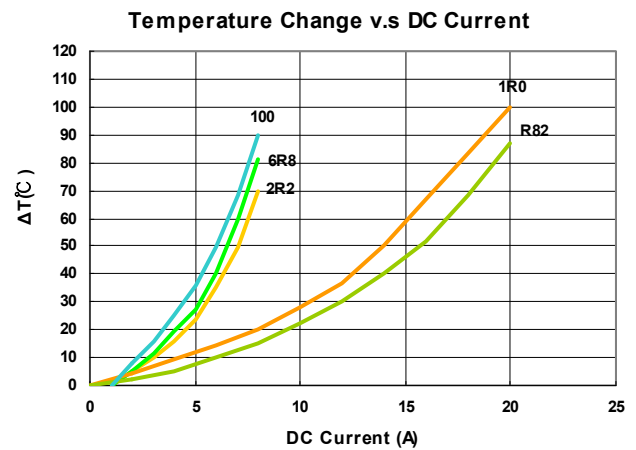
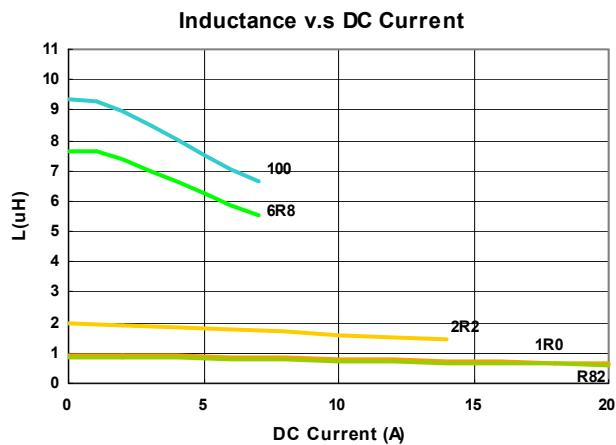

Electrical Characteristics

Part Number	Inductance (μH)	Tolerance ($\pm\%$)	Test Frequency (KHz)	I _{rms} (A)Typ.	I _{sat} (A)Typ.	RDC ($\text{m}\Omega$)Max
MHSC08036-R22M-R8	0.22	20	100	23	40	1.6
MHSC08036-R33M-R8	0.33	20	100	20	38	2.5

- I_{rms} DC current (A) that will cause an approximate ΔT of 40°C
- I_{sat} DC current (A) that will cause L to drop approximately 30%
- Tolerance : M= $\pm 20\%$
- L : WK 3260B, 100KHz 0.5V
- R_{dc} : CHEN HWA 502
- Operating temperature range from -55°C to 125°C . (Including self - temperature rise)

Test Instruments : WK3260B Impedance / Material Analyzer

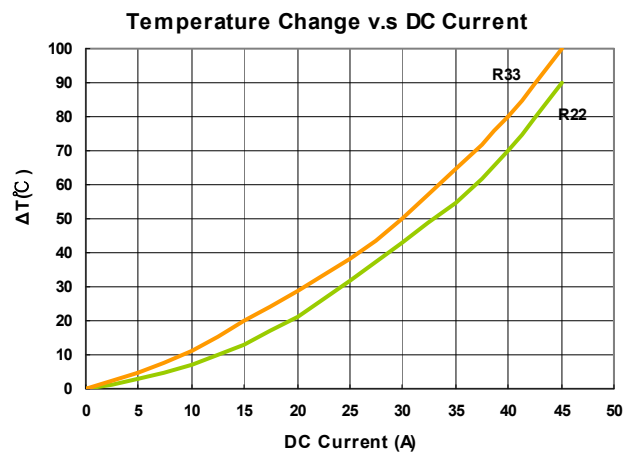
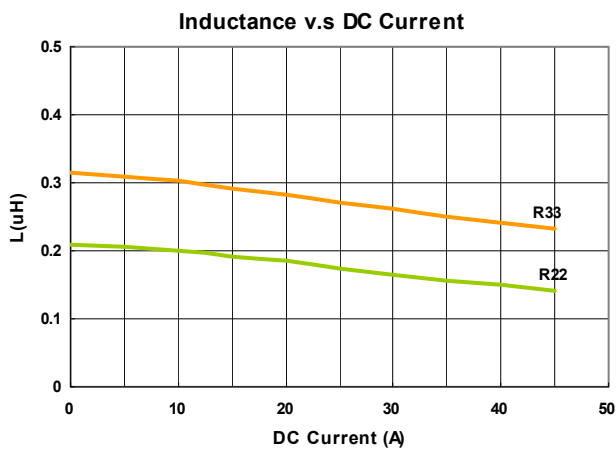

Packaging Specifications

Tape Dimensions

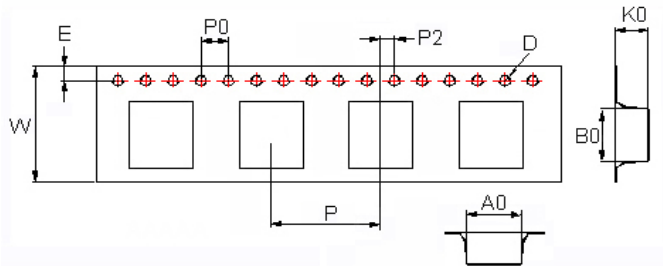

Tape Material

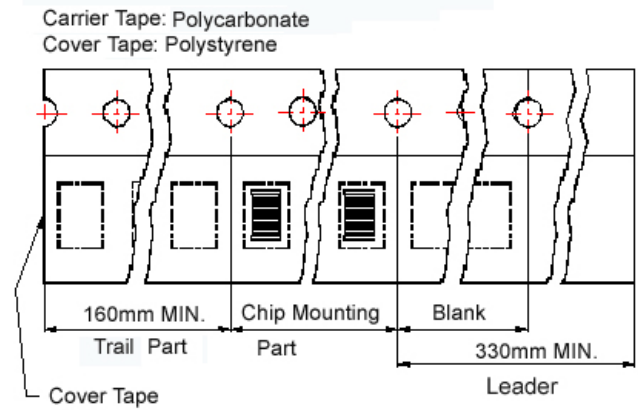

Reel Dimensions

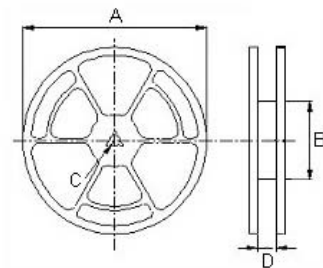

Dimensions in mm

TYPE	Tape Dimensions									Reel Dimensions				Quantity
	A0	B0	K0	D	E	W	P	P0	P2	A	B	C	D	PCS / REEL
04020	4.6	7.2	2.4	1.55	1.75	16	12	4	2	330	100	13	16.0	1000
06022	6.9	10.2	2.6	1.55	1.75	16	12	4	2	330	100	13	16.0	1000
06036	6.9	10.2	4.0	1.55	1.75	16	12	4	2	330	100	13	16.0	1000
08036	8.4	12.6	4.0	1.55	1.75	24	16	4	2	330	100	13	24.4	500