

PRODUCT NUMBER
90311-0XXLF

TOTAL NUMBER OF POS 04 UP TO 50

NOTES:

- 1 - MATERIAL : PA66 25% GLASSFILLED, UL94V-0 COLOR BLACK.
- 2 - SHEET 2 SHOWS THE SINGULAR LATCHING FEATURE FOR 2X2
- 3 - PRODUCT MEETS EUROPEAN UNION DIRECTIVES AND OTHERS REGULATIONS AS DESCRIBED IN GS-22-008.
- 4 - THIS PRODUCT IS NOT INTENDED TO BE EXPOSED TO MANUFACTURING SOLDER PROCESSES.
- 5 - CODING TRIANGLE INDICATES POS 1 WHEN MATED WITH MINITEK HEADER SERIES 98414 / 98417 / 98424 / 98464 / 10072354 / 10074920 AND 10075974.
- 6 - INDICATES POS 1, WHEN MATED WITH SERIES 90309 / 95609 / AND 95615.
- 7 - FOR USE WITH MINITEK CRIMP TO WIRE CONTACT 77138 (26-30AWG) AND 10044403 (22-24AWG).
- 8 - PRODUCT SPECIFICATION AS PER 110-036, CONTACT CRIMP RECOMMENDATIONS AS PER GS-20-058

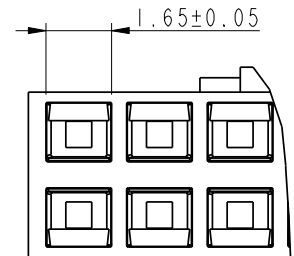
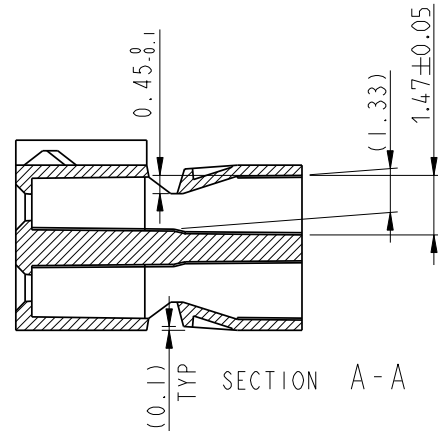
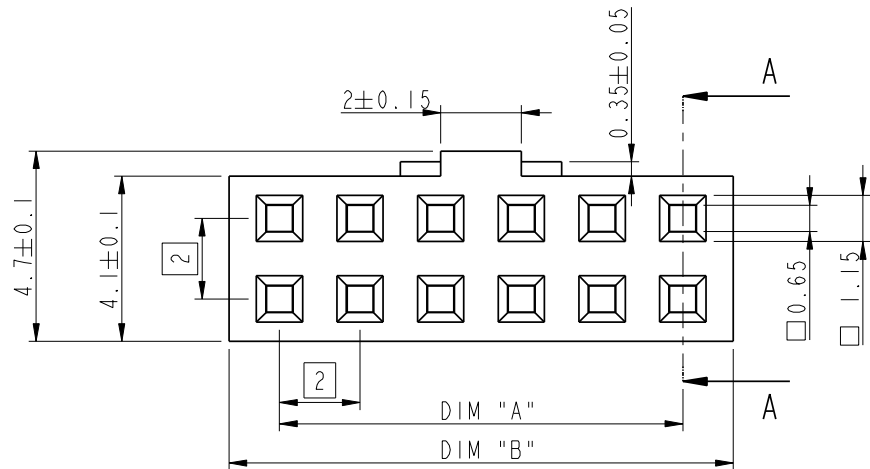
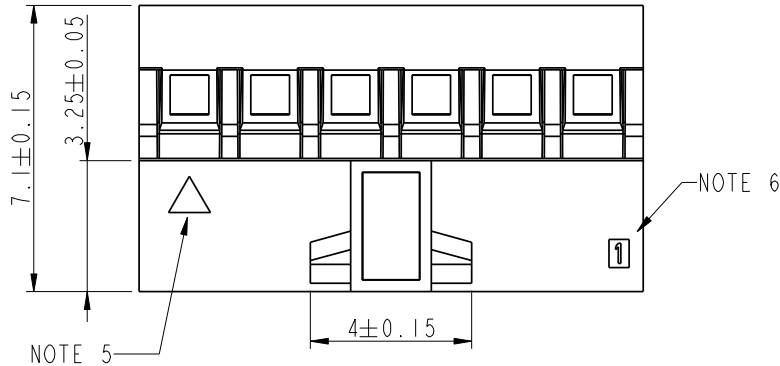

TOLERANCES UNLESS OTHERWISE SPECIFIED

	0.X	±0.3	-	-	-
LINEAR	0.XX	±0.13	-	-	-
	0.XXX	±0.050	-	-	-
ANGULAR	0°	±2°	-	-	-

rev	ecn no	dr	date	Material	SEE NOTE 1	Spec ref	tolerance	projection	MM	
T	V08-0392	HTB	2008-09-12	Mat code	N/A		✓			
U	F12-0004	JCO	2012-01-04	Heattreat	N/A					
V	F12-0073	JCO	2012-06-12	Plating/Finish	N/A					
Dr	D WHITING		1991-08-27	Dr	D WHITING	1991-08-27		size	A3	
Eng	S. OLSON		1991-08-27	Eng	S. OLSON	1991-08-27	Product family	MINITEK	Scale	
Chr	J.COMPAGNON		11.12.01	Chr	J.COMPAGNON	11.12.01	Model Name	90311	ECN	
Appr	JCO		11.12.01	Appr	JCO	11.12.01	Model Revision		REL Level	
						Title MINITEK CTW HSG.DBL ROW POL & LATCHING, HIGH TEMPERATURE		dwg no 90311		Rev. W
				Pro/E file catalog no		CUSTOMER		sheet 1 of 2		

FCI CONFIDENTIAL



This document is the property of and embodies CONFIDENTIAL and PROPRIETARY information of FCI. No part of the information shown on this document may be used in any way or disclosed to others without the written consent of FCI. Copyright FCI.

PRODUCT NUMBER	SIZE	DIM A	DIM B
90311-004LF	2x2	2.0	4.4
90311-006LF	2x3	4.0	6.4
90311-008LF	2x4	6.0	8.4
90311-010LF	2x5	8.0	10.4
90311-012LF	2x6	10.0	12.4
90311-014LF	2x7	12.0	14.4
90311-016LF	2x8	14.0	16.4
90311-018LF	2x9	16.0	18.4
90311-020LF	2x10	18.0	20.4
90311-022LF	2x11	20.0	22.4
90311-024LF	2x12	22.0	24.4
90311-026LF	2x13	24.0	26.4
90311-028LF	2x14	26.0	28.4
90311-030LF	2x15	28.0	30.4
90311-032LF	2x16	30.0	32.4
90311-034LF	2x17	32.0	34.4
90311-036LF	2x18	34.0	36.4
90311-038LF	2x19	36.0	38.4
90311-040LF	2x20	38.0	40.4
90311-042LF	2x21	40.0	42.4
90311-044LF	2x22	42.0	44.4
90311-046LF	2x23	44.0	46.4
90311-048LF	2x24	46.0	48.4
90311-050LF	2x25	48.0	50.4

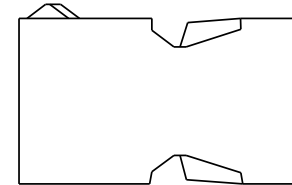
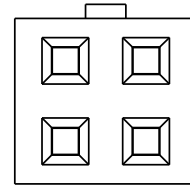
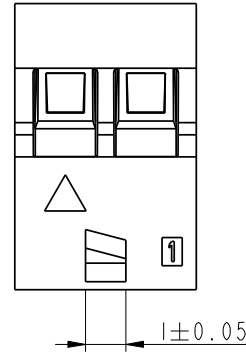

Material		Spec ref		
Mat code	Heattreat	✓	tolerance	projection
Plating/Finish				MM
Dr	D WHITING	1991-08-27		size A3
Eng	S. OLSON	1991-08-27	Product family	Scale 8:1
Chr	J.COMPAGNON	11.12.01	Model Name	90311 ECN
Appr	JCO	11.12.01	Model Revision	REL Level proi_release
	title	MINITEK CTW HSG.DBL ROW		Rev.
		POL & LATCHING, HIGH TEMPERATURE		W
Pro/E file	catalog no	CUSTOMER		sheet 2 of 2