



1.5KE SERIES

GLASS PASSIVATED JUNCTION TRANSIENT VOLTAGE SUPPRESSOR

VOLTAGE 6.8 to 440 Volts **PEAK PULSE POWER** 1500 Watts

DO-201AE

Unit: inch(mm)

FEATURES

- Plastic package has Underwriters Laboratory Flammability Classification 94V-O
- Glass passivated chip junction in DO-201AE package
- 1500W surge capability at 1.0ms
- Excellent clamping capability
- Low zener impedance
- Fast response time: typically less than 1.0 ps from 0 volts to BV min
- Typical IR less than 1µA above 10V
- High temperature soldering guaranteed: 260°C/10 seconds/.375" (9.5mm) lead length/5lbs., (2.3kg) tension
- Pb free product : 99% Sn above can meet RoHS environment substance directive request

MECHANICAL DATA

- Case: JEDEC DO-201AE molded plastic
- Terminals: Axial leads, solderable per MIL-STD-750, Method 2026
- Polarity: Color band denoted cathode except Bipolar
- Mounting Position: Any
- Weight: 0.045 ounce, 1.2 gram

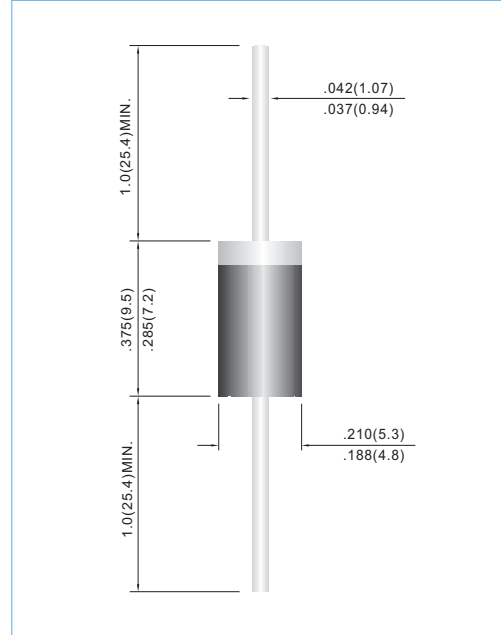

DEVICES FOR BIPOLAR APPLICATIONS

For Bidirectional use C or CA Suffix for types 1.5KE6.8 thru types 1.5KE440.
Electrical characteristics apply in both directions.

MAXIMUM RATINGS AND CHARACTERISTICS

Rating at 25°C ambient temperature unless otherwise specified.

Rating	Symbol	Value	Units
Peak Power Dissipation at $T_A = 25^\circ\text{C}$, $T_P = 1\text{ms}$ (Note 1)	P_{PPM}	1500	Watts
Steady State Power dissipation at $T_J = 75^\circ\text{C}$ Lead Lengths .375", (95mm) (Note 2)	P_D	5.0	Watts
Peak Forward Surge Current, 8.3ms Single Half Sine-Wave (Note 3)	I_{FSM}	200	Amps
Operating Junction and Storage Temperature Range	T_J, T_{STG}	-65 to +175	$^\circ\text{C}$

NOTES:

1. Non-repetitive current pulse, per Fig. 3 and derated above $T_A = 25^\circ\text{C}$ per Fig. 2.
2. Mounted on Copper Leaf area of 0.79 in^2 (20mm^2).
3. 8.3ms single half sine-wave, duty cycle= 4 pulses per minutes maximum.



1.5KE SERIES

Part Number	Part Number	V _{RWM}	V _{BR} @ I _T			I _R @ V _{RWM}		V _C @ I _{PP}	
			Min.	Max.	I _T	UNI-	BI-	V	A
UNI-	BI-	V	V	V	mA	µA	µA	V	A
1.5KE6.8	1.5KE6.8C	5.50	6.12	7.48	10	1000	2000	10.8	139
1.5KE6.8A	1.5KE6.8CA	5.80	6.45	7.14	10	1000	2000	10.5	143
1.5KE7.5	1.5KE7.5C	6.05	6.75	8.25	10	500	1000	11.7	128
1.5KE7.5A	1.5KE7.5CA	6.40	7.13	7.88	10	500	1000	11.3	132
1.5KE8.2	1.5KE8.2C	6.63	7.38	9.02	10	200	400	12.5	120
1.5KE8.2A	1.5KE8.2CA	7.02	7.79	8.61	10	200	400	12.1	124
1.5KE9.1	1.5KE9.1C	7.37	8.19	10.0	1.0	50	100	13.8	109
1.5KE9.1A	1.5KE9.1CA	7.78	8.65	9.50	1.0	50	100	13.4	112
1.5KE10	1.5KE10C	8.10	9.00	11.0	1.0	10	20	15.0	100
1.5KE10A	1.5KE10CA	8.55	9.50	10.5	1.0	10	20	14.5	103
1.5KE11	1.5KE11C	8.92	9.90	12.1	1.0	5	10	16.2	93
1.5KE11A	1.5KE11CA	9.40	10.5	11.6	1.0	5	10	15.6	96
1.5KE12	1.5KE12C	9.72	10.8	13.2	1.0	5	5	17.3	87
1.5KE12A	1.5KE12CA	10.2	11.4	12.6	1.0	5	5	16.7	90
1.5KE13	1.5KE13C	10.5	11.7	14.3	1.0	5	5	19.0	79
1.5KE13A	1.5KE13CA	11.1	12.4	13.7	1.0	5	5	18.2	82
1.5KE15	1.5KE15C	12.1	13.5	16.5	1.0	1	1	22.0	68
1.5KE15A	1.5KE15CA	12.8	14.3	1.8	1.0	1	1	21.2	71
1.5KE16	1.5KE16C	12.9	14.4	17.6	1.0	1	1	23.5	64
1.5KE16A	1.5KE16CA	13.6	15.2	16.8	1.0	1	1	22.5	67
1.5KE18	1.5KE18C	14.5	16.2	19.8	1.0	1	1	26.5	56.5
1.5KE18A	1.5KE18CA	15.3	17.1	18.9	1.0	1	1	25.2	59.5
1.5KE20	1.5KE20C	16.2	18.0	22.0	1.0	1	1	29.1	51.5
1.5KE20A	1.5KE20CA	17.1	19.0	21.0	1.0	1	1	27.7	54
1.5KE22	1.5KE22C	17.8	19.8	24.2	1.0	1	1	31.9	47
1.5KE22A	1.5KE22CA	18.8	20.9	23.1	1.0	1	1	30.6	49
1.5KE24	1.5KE24C	19.4	21.6	26.4	1.0	1	1	34.7	43
1.5KE24A	1.5KE24CA	20.5	22.8	25.2	1.0	1	1	33.2	45
1.5KE27	1.5KE27C	21.8	24.3	29.7	1.0	1	1	39.1	38.5
1.5KE27A	1.5KE27CA	23.1	25.7	28.4	1.0	1	1	37.5	40
1.5KE30	1.5KE30C	24.3	27.0	33.0	1.0	1	1	43.5	34.5
1.5KE30A	1.5KE30CA	25.6	28.5	31.5	1.0	1	1	41.4	36
1.5KE33	1.5KE33C	26.8	29.7	36.3	1.0	1	1	47.7	31.5
1.5KE33A	1.5KE33CA	28.2	31.4	34.7	1.0	1	1	45.7	33
1.5KE36	1.5KE36C	29.1	32.4	39.6	1.0	1	1	52.0	29
1.5KE36A	1.5KE36CA	30.8	34.2	37.8	1.0	1	1	49.9	30
1.5KE39	1.5KE39C	31.6	35.1	42.9	1.0	1	1	56.4	26.5
1.5KE39A	1.5KE39CA	33.3	37.1	41.0	1.0	1	1	53.9	28
1.5KE43	1.5KE43C	34.8	38.7	47.3	1.0	1	1	61.9	24
1.5KE43A	1.5KE43CA	36.8	40.9	45.2	1.0	1	1	59.3	25.3
1.5KE47	1.5KE47C	38.1	42.3	51.7	1.0	1	1	67.8	22.2
1.5KE47A	1.5KE47CA	40.2	44.7	49.4	1.0	1	1	64.8	23.2



1.5KE SERIES

Part Number	Part Number	V _{RWM}	V _{BR} @ I _T			I _R @ V _{RWM}		V _C @ I _{PP}	
			Min.	Max.	I _T	UNI-	BI-	V	A
			V	V	mA	μA	μA		
1.5KE51	1.5KE51C	41.3	45.9	56.1	1.0	1	1	73.5	20.4
1.5KE51A	1.5KE51CA	43.6	48.5	53.6	1.0	1	1	70.1	21.4
1.5KE56	1.5KE56C	45.6	50.4	61.6	1.0	1	1	80.5	18.6
1.5KE56A	1.5KE56CA	47.8	53.2	58.8	1.0	1	1	77.0	19.5
1.5KE62	1.5KE62C	50.2	55.8	68.2	1.0	1	1	89.0	16.9
1.5KE62A	1.5KE62CA	53.0	58.9	65.1	1.0	1	1	85.0	17.7
1.5KE68	1.5KE68C	55.1	61.2	74.8	1.0	1	1	98.0	15.3
1.5KE68A	1.5KE68CA	58.1	64.6	71.4	1.0	1	1	92.0	16.3
1.5KE75	1.5KE75C	60.7	67.5	82.5	1.0	1	1	108	13.9
1.5KE75A	1.5KE75CA	64.1	71.3	78.8	1.0	1	1	103	14.6
1.5KE82	1.5KE82C	66.4	73.8	90.2	1.0	1	1	118	12.7
1.5KE82A	1.5KE82CA	70.1	77.9	86.1	1.0	1	1	113	13.3
1.5KE91	1.5KE91C	73.7	81.9	100	1.0	1	1	131	11.4
1.5KE91A	1.5KE91CA	77.8	86.5	95.5	1.0	1	1	125	12.0
1.5KE100	1.5KE100C	81.0	90.0	110	1.0	1	1	144	10.4
1.5KE100A	1.5KE100CA	85.5	95.0	105	1.0	1	1	137	11.0
1.5KE110	1.5KE110C	89.2	99.0	121	1.0	1	1	158	9.5
1.5KE110A	1.5KE110CA	94.0	105	116	1.0	1	1	152	9.9
1.5KE120	1.5KE120C	97.2	108	132	1.0	1	1	173	8.7
1.5KE120A	1.5KE120CA	102	114	126	1.0	1	1	165	9.1
1.5KE130	1.5KE130C	105	117	143	1.0	1	1	187	8.0
1.5KE130A	1.5KE130CA	111	124	137	1.0	1	1	179	8.4
1.5KE150	1.5KE150C	121	135	165	1.0	1	1	215	7.0
1.5KE150A	1.5KE150CA	128	143	158	1.0	1	1	207	7.2
1.5KE160	1.5KE160C	130	144	176	1.0	1	1	230	6.5
1.5KE160A	1.5KE160CA	136	152	168	1.0	1	1	219	6.8
1.5KE170	1.5KE170C	138	153	187	1.0	1	1	244	6.2
1.5KE170A	1.5KE170CA	145	162	179	1.0	1	1	234	6.4
1.5KE180	1.5KE180C	146	162	198	1.0	1	1	258	5.8
1.5KE180A	1.5KE180CA	154	171	189	1.0	1	1	246	6.1
1.5KE200	1.5KE200C	162	180	220	1.0	1	1	287	5.2
1.5KE200A	1.5KE200CA	171	190	210	1.0	1	1	274	5.5
1.5KE220	1.5KE220C	175	198	242	1.0	1	1	344	4.3
1.5KE220A	1.5KE220CA	185	209	231	1.0	1	1	328	4.6
1.5KE250	1.5KE250C	202	225	275	1.0	1	1	360	4.3
1.5KE250A	1.5KE250CA	214	237	263	1.0	1	1	344	4.6
1.5KE300	1.5KE300C	243	270	330	1.0	1	1	430	3.6
1.5KE300A	1.5KE300CA	256	285	315	1.0	1	1	414	3.8
1.5KE350	1.5KE350C	284	315	385	1.0	1	1	504	3.1
1.5KE350A	1.5KE350CA	300	332	368	1.0	1	1	482	3.2
1.5KE400	1.5KE400C	324	360	440	1.0	1	1	574	2.7
1.5KE400A	1.5KE400CA	342	380	420	1.0	1	1	548	2.8
1.5KE440	1.5KE440C	356	396	484	1.0	1	1	631	2.4
1.5KE440A	1.5KE440CA	376	418	462	1.0	1	1	600	2.6



1.5KE SERIES

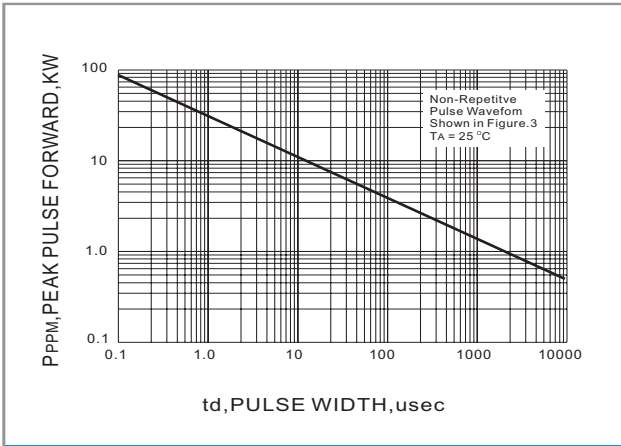

Fig. 1 PEAK PULSE POWER RATING VERSUS PULSE TIME CURVE

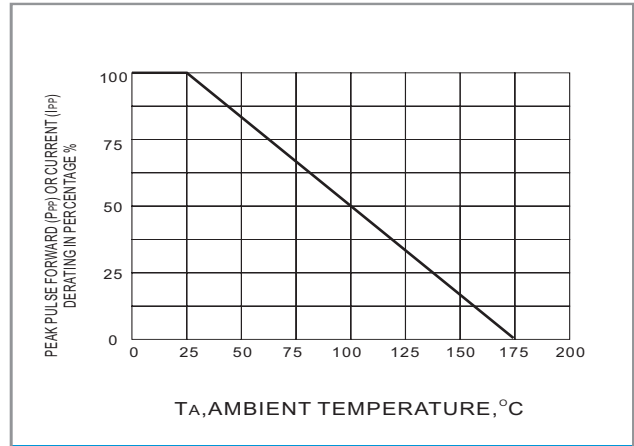

Fig. 2 PULSE DERATING CURVE

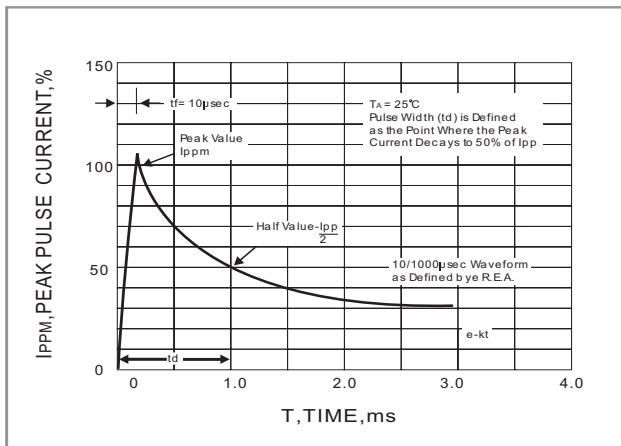

Fig. 3 PULSE WAVEFORM

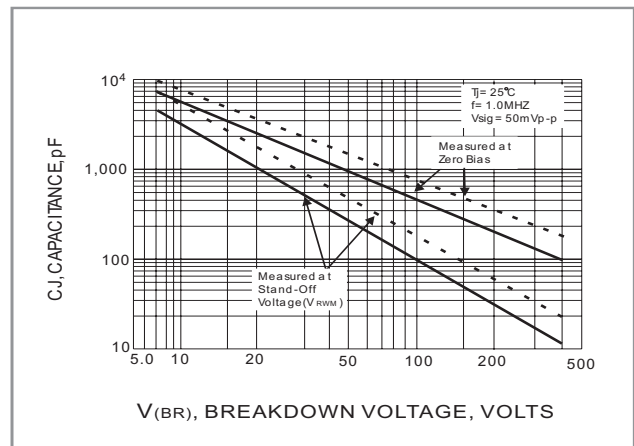

Fig. 4 TYPICAL JUNCTION CAPACITANCE

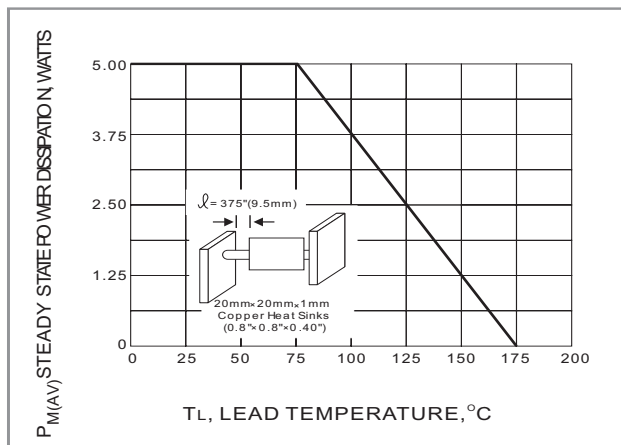

Fig. 5 STEADY STATE POWER DERATING

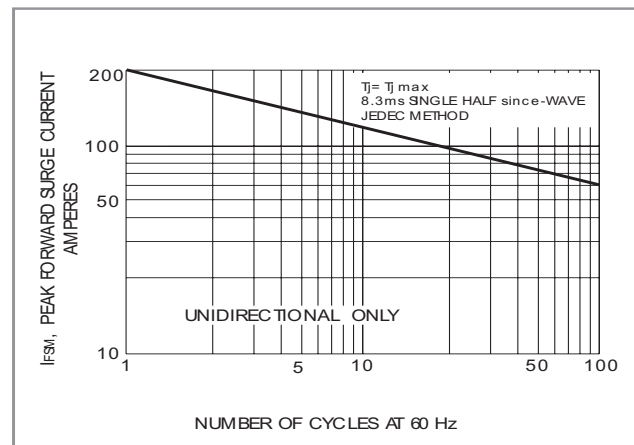

Fig. 6 MAXIMUM NON-REPETITIVE PEAK FORWARD SURGE CURRENT UNIDIRECTIONAL

LEGAL STATEMENT

Copyright PanJit International, Inc 2005

The information presented in this document is believed to be accurate and reliable. The specifications and information herein are subject to change without notice. Pan Jit makes no warranty, representation or guarantee regarding the suitability of its products for any particular purpose. Pan Jit products are not authorized for use in life support devices or systems. Pan Jit does not convey any license under its patent rights or rights of others.