

Universal PLC Interface with PDT Relay – now also with spring cage connection system!

The PLC-R...21 relay series, that can be used universally, consisting of 6.2 mm base terminal blocks and pluggable miniature relays with PDT contact, has now been included in the range with **spring cage connections**. The wiring, diagonally from above, is particularly convenient during assembly. The cost-intensive wiring is reduced yet again when the plug-in bridges are implemented. A side-effect is a cut in the likelihood of faulty wiring and time-consuming trouble-shooting.

PDT = great flexibility

The universal PDT series, PLC-RSP...21, is used whenever an application demands great flexibility. It can be used

- as an input or output interface or
- in N/C, N/O or PDT applications.

Advantage: fewer ordering and warehousing items. In the standard version, the PLC interfaces are supplied equipped complete with relay (or miniature optical coupler with electronic N/O function).

Input voltages of 12V to 230V

PLC-RSP...21 on the coil side is, like the proven screw clamp versions, available in all conventional industrial voltages from 12 V to 230 V. A further advantage is the ready-integrated input circuit. It consists of a status display, damping function, and polarity reversal protection function, and guarantees a clear display of the operational status, EMC interference suppression of the coil, and prevents destruction of the same, should the polarity be accidentally reversed.

Robust miniature relay

The heart of the PDT relay series is a robust miniature relay from the latest generation, equipped with features that you will search for in vain in most standard pluggable relays:

- Operational safety with IP67-protected mechanics,
- Environmentally friendly, cadmium-free power contact material for loads up to 250 V AC/6 A,
- As an alternative with a gold layer for smaller capacities (mA),
- Reliable isolation in acc. with DIN VDE 0106-101,
- $4kV_{rms}$ potential separation between coil and contact.

The relay is securely fastened using an engagement lever. Should it become worn, it can be disengaged, and – without disconnecting the wiring – replaced quickly and economically.

Plug-in bridges save wiring

A big plus for cunning wiring professionals is the convenient plug-in bridge system FBST. Whether there is an A1/A2 ground on the coil side, or group feed-in at

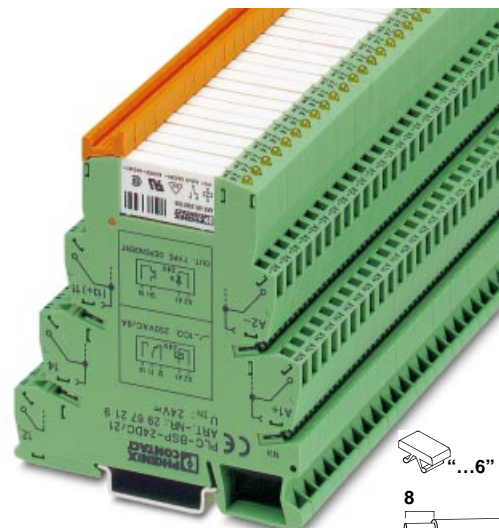

(IEC) [mm ²]	rigid solid	flexible stranded	AWG	I [A]	U [V]
Connection data	0.2-2.5	0.2-1.5	24-14	*	*

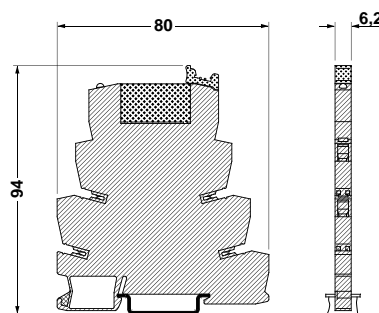
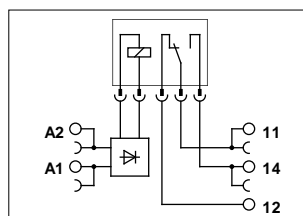

* The electrical data are determined by the relay.



contact 11 on the contact side, the continuous plug-in bridges which can be cut to length as desired, or the 2-position jumper plugs guarantee with one "click" quick, economical and fault-free wiring, whilst providing utmost clarity. This makes complicated, time-consuming loop bridges a thing of the past!

Universal PLC Interface with PDT Relay

– now also with spring cage connection system!

Description	Input voltage $U_N^{1)}$	Type	Order No.	Pcs./ Pkt.
PLC interface , consisting of base terminal block PLC-BSP.../21 and pluggable miniature relay (see catalog part 6, page 32), for mounting on 	24 V DC	equipped with universal multi-layer contact relay PLC-RSP- 24DC/21AU	29 66 54 0	10
	24 V AC/DC	PLC-RSP- 24UC/21AU	29 66 55 3	10
	120 V AC/220 V DC	PLC-RSP-120UC/21AU	29 66 58 2	10
	230 V AC/220 V DC ²⁾	PLC-RSP-230UC/21AU	29 66 64 7	10
PLC interface , consisting of base terminal block PLC-BSP.../21 and pluggable miniature relay (see catalog part 6, page 32), for mounting on 	24 V DC	equipped with power contact relay PLC-RSP- 24DC/21	29 66 47 2	10
	24 V AC/DC	PLC-RSP- 24UC/21	29 66 48 5	10
	120 V AC/220 V DC	PLC-RSP-120UC/21	29 66 52 4	10
	230 V AC/220 V DC ²⁾	PLC-RSP-230UC/21	29 66 53 7	10

Technical data

Input data

Nominal input voltage U_N	24 V DC	24 V AC/DC	120 V AC/ 110 V DC	230 V AC/ 220 V DC ²⁾
Permissible input voltage range	see diagram, catalog part 6, page 25			
Typ. input current at U_N	9 mA	11/8.5 mA	3.5/3 mA	3 mA
Typ. response time at U_N	5 ms	6 ms	6 ms	7 ms
Typ. release time at U_N	8 ms	15 ms	15 ms	15 ms
Input circuit	24 V DC	operation indicator, polarity protection diode, damping diode		
	24, 120, 230 V AC/DC	operation indicator, bridge rectifier		

Output data

	PLC-R.../21	PLC-R.../21AU
Contact type	single contact, 1 PDT	single contact, 1 PDT
Contact material	AgSnO	AgSnO + 5 μ Au ³⁾
Max. switching voltage	250 V AC/DC ²⁾	30 V AC/36 V DC
Min. switching voltage	12 V AC/DC	100 mV
Limiting continuous current	6 A	50 mA
Max. inrush current	on request	50 mA
Min. switching current	10 mA	1 mA
Max. power rating, ohmic load:	24 V DC 48 V DC 60 V DC 110 V DC 220 V DC 250 V AC	140 W 20 W 18 W 23 W 40 W 1500 VA
Min. switching capacity	120 mW	100 μ W

General data

Test voltage input/output	4 kV, 50 Hz, 1 min.
Ambient temperature range	- 20 °C to + 55 °C (24 V types to + 60 °C)
Duty type rating	100 % ED
Inflammability class	V0 in acc. with UL 94
Mechanical service life	10 ⁷ cycles
Standards/regulations	IEC 664/IEC 664 A/DIN VDE 0110, contamination class 3, Surge voltage category III, DIN VDE 0160 (in relev. parts), IEC 255/DIN VDE 0435 (in relev. parts), DIN VDE 0106-101: 1986-11, increased insulation I/O ⁴⁾
Installation position/assembly	as desired, in rows with zero spacing
Type of connection	spring cage connection

¹⁾ Further input voltages available on request.

²⁾ For voltages higher than 250 V (e.g. L1, L2, L3) between identical terminal blocks of adjacent modules, the PLC-ATP separating plate (see catalog part 6, page 34) should be installed.

³⁾ If the maximum values indicated are exceeded, the gold layer is destroyed. The values of the AgSnO contact are then valid.

⁴⁾ For protective isolation between identical terminal blocks of adjacent modules, the PLC-ATP separating plate (see catalog part 6, page 34) should be installed.

Notes:

Type of housing: polyamide PA non-reinforced, Color: green, see catalog part 6, page 149

Marking systems and mounting material, see catalog part 3/4.

The rated cross section (see catalog part 6, page 151) refers to untreated conductors without ferrules.

For the protection of input and output, inductive loads must be dampened with an effective protection circuit.

Due to the input circuit integrated in the base terminal block, a 60 V relay, REL-MR-60DC/... is used with the 120 V and 230 V modules. (see catalog part 6, page 32)

The PLC-ATP separating plate (see catalog part 6, page 34) must always be installed at the beginning and end of a PLC terminal strip.

Universal PLC Interface with Optical Coupler – now also with spring cage connection system!

The PLC-O.. optical coupler series, that can be used universally, consisting of pluggable miniature optical couplers and the same 6.2 mm base terminal blocks as in the PDT series, has now been included with **spring cage connections** in the range. The wiring, diagonally from above, is particularly convenient during assembly. The cost-intensive wiring is reduced yet again when the plug-in bridges are implemented. A side-effect is a cut in the likelihood of faulty wiring and time-consuming trouble-shooting.

The standard PLC-OSP series can be implemented either as an input or output interface, thus simplifying ordering, and saving costs for warehousing and service. Since the unit is already completely equipped, there is no additional work involved with inserting the optical coupler. To allow even more flexibility, all individual components (base terminal block, optical coupler or relay) can also be ordered separately and combined individually.

Input voltages of 24 V to 230 V

PLC-OSP... on the control side is, like the proven screw clamp versions, available in all conventional industrial voltages from 24 V to 230 V. A further advantage is the ready-integrated input circuit. It consists of a status display and polarity reversal protection function, and guarantees that the operational status is displayed clearly, also preventing destruction of the optical electronics should the polarity be accidentally reversed.

Efficient miniature optical couplers

- Despite its small dimensions, the PLC miniature optical coupler is unusually efficient, has the typical sturdiness of optical couplers and is the instrument of choice especially with high operating frequencies:
- Switching capacity of up to 24 V DC/2 A, depending on the type,
 - IP 67-protected fully encapsulated optical electronics,
 - 2. kV_{rms} electrical insulation between input/output,
 - Input or power optical couplers can be supplied as alternatives,
 - Wear-resistant switching,
 - Insensitive to vibration and shock.

The optical coupler is securely anchored by an engagement lever. In the unlikely event of the optical coupler needing to be repaired, it can be disengaged, and – without disconnecting the wiring – replaced quickly and economically.

Plug-in bridges save wiring

A big plus for cunning wiring professionals is the convenient plug-in bridge system FBST. Whether there is an A1/A2 ground on the control side, or supply at

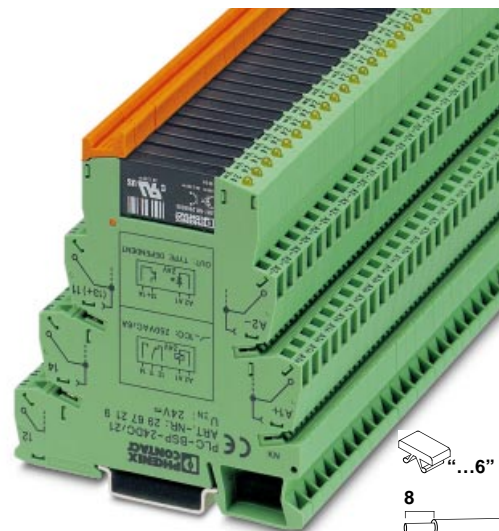

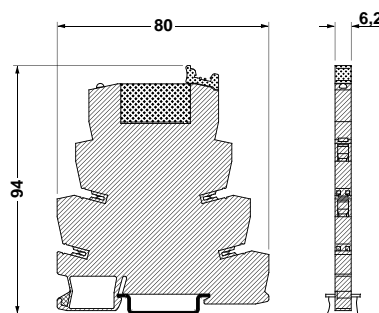
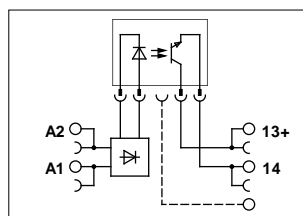

	(IEC) [mm ²]	rigid solid	flexible stranded	AWG	I [A]	U [V]
Connection data		0.2-2.5	0.2-1.5	24-14	*	*
* The electrical data are determined by the relay.						



contact 13 on the load side, the continuous plug-in bridges, which can be cut to length as desired, or the 2-position jumper plugs guarantee quick, economical and fault-free wiring, whilst providing utmost clarity. This makes complicated, time-consuming loop bridges a thing of the past!

Universal PLC Interface with Optical Coupler

– now also with spring cage connection system!

Description	Input voltage U_N ¹⁾	Type	Order No.	Pcs./ Pkt.
PLC interface , consisting of base terminal block PLC-BSP.../21 and pluggable miniature optical coupler (see catalog part 6, page 33), for mounting on 	24 V DC 120 V AC/110 V DC 230 V AC/220 V DC ²⁾	equipped with input optical coupler PLC-OSP-24DC/48DC/100 PLC-OSP-120UC/48DC/100 PLC-OSP-230UC/48DC/100	29 67 54 9 29 67 55 2 29 67 56 5	10 10 10
PLC interface , consisting of base terminal block PLC-BSP.../21 and pluggable miniature optical coupler (see catalog part 6, page 33), for mounting on 	24 V DC 120 V AC/110 V DC 230 V AC/220 V DC ²⁾	equipped with power optical coupler PLC-OSP-24DC/24DC/2 PLC-OSP-120UC/24DC/2 PLC-OSP-230UC/24DC/2	29 67 47 1 29 67 48 4 29 67 49 7	10 10 10
Technical data		Input optical coupler	Power optical coupler	
Input data				
Nominal input voltage U_N		24 V DC	120 V AC/ 110 V DC 230 V AC/ 220 V DC ²⁾	24 V DC
Permissible range (in reference to U_N)		0.8-1.2	0.8-1.1	0.8-1.2
Switching level 1-Signal ("H")		$0.8 \times U_N$	$0.8 \times U_N$	$0.8 \times U_N$
0-Signal ("L")		$0.4 \times U_N$	$0.3 \times U_N$	$0.25 \times U_N$
Typ. input current at U_N		8 mA	4 mA	9 mA
Typ. turn-on time for U_N		20 μ s	6 ms	20 μ s
Typ. turn-off time for U_N		300 μ s	10 ms	500 μ s
Transmission frequency f_{limit}		300 Hz	10 Hz	300 Hz
Input circuit	24 V DC 24, 120, 230 V AC/DC	operation indicator, polarity protection diode, damping diode operation indicator, bridge rectifier		
Output data		PLC-O.../48DC/100	PLC-O.../24DC/2	
Max. switching voltage		48 V DC	33 V DC	
Min. switching voltage		3 V DC	3 V DC	
Limiting continuous current		100 mA	2 A (see derating curve catalog part 6, page 27)	
Max. inrush current		–	15 A (10 ms)	
Min. switching current		–	–	
Output connection		2-conductor floating	2-conductor floating	
Output circuit		polarity reversal protection and surge voltage protection	polarity reversal protection and surge voltage protection	
Voltage drop at max. limiting continuous current		≤ 1 V	≤ 200 mV	
General data		2.5 kV, 50 Hz, 1 min. – 20 °C to + 60 °C 100 % ED V0 in acc. with UL 94 IEC 664/IEC 664 A/DIN VDE 0110, contamination class 2, surge voltage protection category III, as desired, in rows with zero spacing spring cage connection		
Test voltage input/output				
Ambient temperature range				
Duty type rating				
Inflammability class				
Standards/regulations				
Installation position/assembly				
Type of connection				

¹⁾ Further input voltages available on request.

²⁾ For voltages higher than 250 V (e.g. L1, L2, L3) between identical terminal blocks of adjacent modules, the PLC-ATP separating plate (see catalog part 6, page 34) should be installed.

Notes:

Type of housing: polyamide PA non-reinforced,
Color: green, see catalog part 6, page 149

Marking systems and mounting material, see catalog part 3/4.

The rated cross section (see catalog part 6, page 151) refers to untreated conductors without ferrules.

For the protection of input and output, inductive loads must be dampened with an effective protection circuit.

Due to the input circuit integrated in the base terminal block (see catalog part 6, page 33), a 60 V optical coupler, OTP-60DC/..., is used with the 120 V and 230 V modules.

The PLC-ATP separating plate must always be installed at the beginning and end of a PLC terminal strip.

For protective isolation between identical terminal blocks of adjacent modules, the PLC-ATP separating plate (see catalog part 6, page 34) should be installed.

PLC Actuator Interface with Relay

– now also with spring cage connection system!

In interface applications between the PLC and actuators, such as motors, contactors, or solenoid valves, only an N/O contact is normally required. Here, people turn directly to the PLC-RSP...ACT output interface, specially optimized for these applications and consisting of a 6.2 mm base terminal block and pluggable miniature relay. In addition to the proven screw clamp connection version, the actuator interface is now available with **spring cage connections**. The wiring, diagonally from above, is particularly convenient during assembly. Alternatively, the actuator interface can also be supplied with a miniature optical coupler.

No need for output terminal blocks

Unlike conventional coupling relays, all the actuator connections, including the load return line (!), are connected directly to the PLC actuator interface. PLC-RSP...ACT can thus be used directly as an output terminal strip with integrated interface function for the outgoing actuator cables, without the need for additional modular terminal blocks. (See also structural diagram in catalog part 6, page 28.)

Assessment of savings:

- Elimination of the costs of two output terminal blocks for switching and load return lines,
- Space savings of approx. 80%,
- Time saving approx. 60%,
- Reduction in wiring thanks to plug-in bridges.

Optimum use of plug-in bridges.

The actuator interface attains the maximum degree of efficiency with the convenient FBST plug-in bridge system. PLC-RSP...ACT makes effective use of the bridging facilities for the A1/A2 connection on the coil side, for the load supply at connection 13 on the contact side, and for the load return line. Especially effective here are the 500 mm long color-insulated continuous bridges that can easily be cut to the required length and inserted in the bridge shafts in a flash. No stripping, no pressing on of ferrules, no connecting. This makes complicated, time-consuming loop bridges a thing of the past!

Assessment of savings:

- Reduction in wiring by eliminating the need for modular terminal blocks and using all bridging facilities: approx. 60%.

Further advantages:

PLC-RSP...ACT naturally offers the same benefits as all other PLC series with relay:

- Available either as gold or power contact relay,
- Integrated input circuit,
- Switching capacity up to 250 V AC/6 A,
- The relay can be removed for replacement using the



(IEC) [mm ²]	rigid solid	flexible stranded	AWG	I [A]	U [V]
Connection data	0.2-2.5	0.2-1.5	24-14	*	*

* The electrical data are determined by the relay.

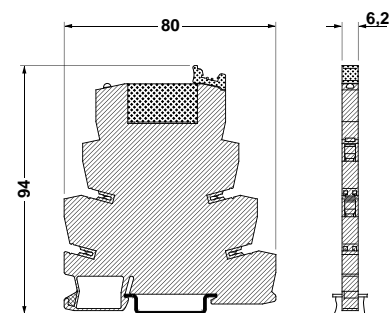
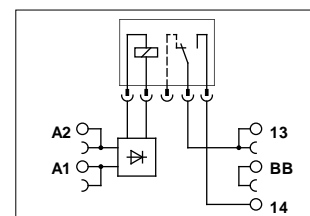

- engagement lever,
- Operational safety with IP67-protected relays
- Reliable isolation acc. to DIN VDE 0106-101
- User-specific marking
- Inflammability class V0 in acc. with UL94.

PLC Actuator Interface with Relay – now also with spring cage connection!

Description	Input voltage U_N	Type	Order No.	Pcs./ Pkt.
PLC interface , consisting of base terminal block PLC-BSP...ACT and pluggable miniature relay (see catalog part 6, page 32), for mounting on 	24 V DC ²⁾	equipped with power contact relay PLC-RSP- 24DC/ACT	29 67 34 5	10

Technical data

Input data

Nominal input voltage U_N
Permissible input voltage range
Typ. input current at U_N
Typ. response time at U_N
Typ. release time at U_N
Input circuit

24 V DC

24 V DC
see diagram catalog part 6, page 25
9 mA
5 ms
8 ms
operation indicator, polarity protection diode, damping diode

Output data

Contact type
Contact material
Max. switching voltage
Min. switching voltage
Limiting continuous current
Max. inrush current
Min. switching current
Max. power rating, ohmic load:

24 V DC
48 V DC
60 V DC
110 V DC
220 V DC
250 V AC

single contact, 1 N/O contact⁴⁾
AgSnO
250 V AC/DC ²⁾
12 V AC/DC
6 A
on request
10 mA
140 W
20 W
18 W
23 W
40 W
1500 VA
120 mW

Min. switching capacity

120 mW

General data

Test voltage input/output
Ambient temperature range
Duty type rating
Inflammability class
Mechanical service life
Standards/regulations

4 kV, 50 Hz, 1 min.
– 20 °C to + 60 °C
100 % ED
V0 in acc. with UL 94
10⁷ cycles
IEC 664/IEC 664 A/DIN VDE 0110, contamination class 3,
Surge voltage category III, DIN VDE 0160 (in relev. parts),
IEC 255/DIN VDE 0435 (in relev. parts), DIN VDE 0106-101: 1986-11,
increased insulation I/O ³⁾
as desired, in rows with zero spacing
spring cage connection

Installation position/assembly
Type of connection

Notes:

- 1) Further input voltages available on request.
- 2) For voltages higher than 250 V (e.g. L1, L2, L3) between identical terminal blocks of adjacent modules, the PLC-ATP separating plate (see catalog part 6, page 34) should be installed.
- 3) For protective isolation between identical terminal blocks of adjacent modules, the PLC-ATP separating plate (see catalog part 6, page 34) should be installed.
- 4) N/C contact on request.

**Type of housing: polyamide PA non-reinforced,
Color: green, see catalog part 6, page 149**

Marking systems and mounting material, see catalog part 3/4.

The rated cross section (see catalog part 6, page 151) refers to untreated conductors without ferrules.

For the protection of input and output, inductive loads must be dampened with an effective protection circuit.

The PLC-ATP separating plate (see catalog part 6, page 34) must always be installed at the beginning and end of a PLC terminal strip.

PLC Actuator Interface with Optical Coupler – now also with spring cage connection system!

In interface applications between the PLC and actuators, such as motors, contactors, or solenoid valves, only an N/O function is normally required. Here, people turn directly to the PLC-OSP...ACT output interface, specially optimized for these applications and consisting of a 6.2 mm base terminal block and pluggable miniature optical coupler. In addition to the proven screw clamp connection version, the actuator interface is now available with **spring cage connections**. The wiring, diagonally from above, is particularly convenient during assembly. Alternatively, the actuator interface can also be supplied with a miniature relay.

No need for output terminal blocks!

Unlike conventional coupling relays, all the actuator connections, including the load return line (!), are connected directly to the PLC actuator interface. PLC-OSP...ACT can thus be used directly as an output terminal strip with integrated interface function for the outgoing actuator cables, without the need for additional modular terminal blocks. (See also structural diagram in catalog part 6, page 28.)

Assessment of savings:

- Elimination of the costs of two output terminal blocks for switching and load return lines,
- Space savings of approx. 80%,
- Time saving approx. 60%,
- Reduction in wiring thanks to plug-in bridges.

Optimum use of plug-in bridges

The actuator interface attains the maximum degree of efficiency with the convenient FBST plug-in bridge system. PLC-OSP...ACT makes effective use of the bridging facilities for the A1/A2 connection on the coil side, for the load supply at connection 13 on the contact side, and for the load return line. Especially effective here are the 500 mm long color-insulated continuous bridges that can easily be cut to the required length and inserted in the bridge shafts in a flash. No stripping, no pressing on of ferrules, no connecting. This makes complicated, time-consuming loop bridges a thing of the past!

Assessment of savings:

- Reduction in wiring by eliminating the need for modular terminal blocks and using all bridging facilities: approx. 60%.

Further advantages:

PLC-OSP...ACT naturally offers the same benefits as all other PLC series with optical coupler:

- Switching capacity of up to 24 V DC/2 A, depending on the type,
- Wear-resistant switching,
- Integrated input circuit,



(IEC) [mm ²]	rigid solid	flexible stranded	AWG	I [A]	U [V]
Connection data	0.2-2.5	0.2-1.5	24-14	*	*

* The electrical data are determined by the relay.

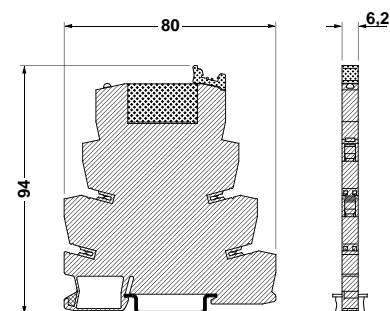
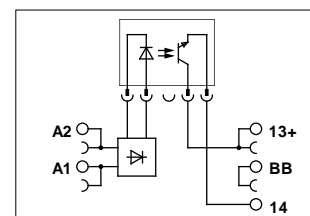

- Input or power optical coupler can be supplied,
- Optical coupler can be removed for replacement using the engagement lever,
- IP67-protected fully encapsulated optical electronics,
- Insensitive to vibration and shock,
- User-specific marking
- Inflammability class V0 in acc. with UL94.

Headquarters: © Phoenix Contact GmbH & Co. KG • Flachsmarktstraße 8-28 • 32825 Blomberg • Germany
Phone +49-(0) 52 35-3-00 • Fax +49-(0) 52 35-3-4 12 00 • <http://www.phoenixcontact.com>

PLC Actuator Interface with Optical Coupler – now also with spring cage connection system!

Description	Input voltage U_N ¹⁾	Type	Order No.	Pcs./ Pkt.
PLC interface , consisting of base terminal block PLC-BSP...ACT and pluggable miniature optical coupler (see catalog part 6, page 33), for mounting on 	24 V DC	equipped with power optical coupler PLC-OSP- 24DC/24DC/2/ACT	29 67 50 7	10

Technical data

Input data

Nominal input voltage U_N
 Permissible range (in reference to U_N)
 Switching level 1 signal ("H")
 0 signal ("L")
 Typ. input current at U_N
 Typ. turn-on time for U_N
 Typ. turn-off time for U_N
 Transmission frequency f_{limit}
 Input circuit

24 V DC
 0.8-1.2
 $0.8 \times U_N$
 $0.4 \times U_N$
 8 mA
 20 μ s
 300 μ s
 300 Hz

24 V DC

operation indicator, polarity protection diode, damping diode

Output data

Max. switching voltage
 Min. switching voltage
 Limiting continuous current
 Max. inrush current
 Output connection
 Output circuit
 Voltage drop at max. limiting continuous current

33 V DC
 3 V DC
 2 A (see derating curve, catalog part 6, page 27)
 15 A (10 ms)
 2-conductor floating
 polarity reversal protection and surge voltage protection
 ≤ 200 mV

General data

Test voltage input/output
 Ambient temperature range
 Duty type rating
 Inflammability class
 Standards/regulations
 Installation position/assembly
 Type of connection

2.5 kV, 50 Hz, 1 min.
 – 20 °C to + 60 °C
 100 % ED
 V0 in acc. with UL 94
 IEC 664/IEC 664 A/DIN VDE 0110,
 contamination class 2, surge voltage protection category III,
 as desired, in rows with zero spacing
 spring cage connection

¹⁾ Further input voltages available on request.

Notes:

Type of housing: polyamide PA non-reinforced,
Color: green, see catalog part 6, page 149

Marking systems and mounting material, see catalog part 3/4.

The rated cross section (see catalog 6, page 151) refers to untreated conductors without ferrules.

For the protection of input and output, inductive loads must be dampened with an effective protection circuit.

The PLC-ATP separating plate must always be installed at the beginning and end of a PLC terminal strip.

For protective isolation between identical terminal blocks of adjacent modules, the PLC-ATP separating plate (see catalog part 6, page 34) should be installed.

PLC Sensor Interface with Relay

– now also with spring cage connection system!

In interface applications between the PLC and sensors, such as proximity switches, limit switches, or auxiliary contacts, often only an N/O function is required. Here, people turn directly to the PLC-RSP...SEN input interface, specially optimized for these applications and consisting of a 6.2 mm base terminal block and pluggable miniature relay. In addition to the proven screw clamp connection version, the sensor interface is now available with **spring cage connections**. The wiring, diagonally from above, is particularly convenient during assembly.

No need for input terminal blocks

Unlike previous input relays, all the sensor connections, including the voltage supply for the sensors/switches (!), are connected directly to the PLC sensor interface. PLC-RSP...SEN can thus be used directly as a terminal strip with integrated interface function for the incoming sensor cables, without the need for additional modular terminal blocks. (See also structural diagram in catalog part 6, page 30.)

Assessment of savings:

- Elimination of the costs of two (three) modular terminal blocks for sensor/switch supply, signal and sensor ground (in the case of three-conductor initiators).
- Space savings of approx. 80 %,
- Time saving approx. 60 %,
- Reduction in wiring thanks to plug-in bridges.

Optimum use of plug-in bridges.

The sensor interface attains the maximum degree of efficiency with the convenient FBST plug-in bridge system. PLC-RSP...SEN makes effective use of the bridging facilities for the sensor/switch voltage supply, for the supply and sensor ground at the A2 connection, and for the common supply potential of the PLC at connection 13. No stripping, no pressing on of ferrules, no connecting. This makes complicated, time-consuming loop bridges a thing of the past!

Assessment of savings:

- Reduction in wiring by eliminating the need for modular terminal blocks and using all bridging facilities: approx. 60 %.

Further advantages:

PLC-RSP...ACT naturally offers the same benefits as all other PLC series with relay:

- Switching capacity up to 250 V AC/6 A,
- Integrated input circuit,
- Available either as gold or power contact relay,
- The relay can be removed for replacement using the engagement lever,
- Operational safety with IP67-protected relays,

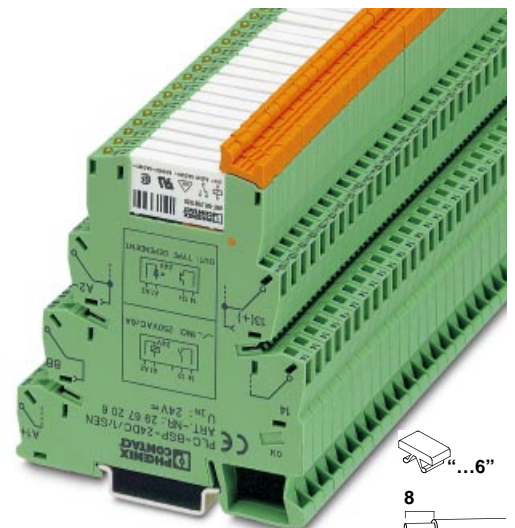

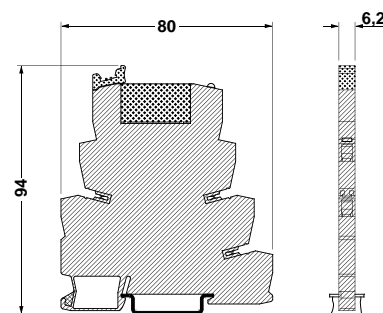
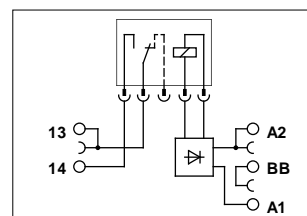

(IEC) [mm ²]	rigid solid	flexible stranded	AWG	I [A]	U [V]
Connection data	0.2-2.5	0.2-1.5	24-14	*	*

* The electrical data are determined by the relay.



- Reliable isolation acc. to DIN VDE 0106-101
- User-specific marking
- Inflammability class V0 in acc. with UL94.

PLC Sensor Interface with Relay – now also with spring cage connection system!

Description	Input voltage U_N ¹⁾	Type	Order No.	Pcs./ Pkt.
PLC interface , consisting of base terminal block PLC-BSP...SEN and pluggable miniature relay (see catalog part 6, page 32), for mounting on 	24 V DC 120 V AC/110 V DC 230 V AC/220 V DC ²⁾	equipped with universal multi-layer contact relay PLC-RSP- 24DC/1AU/SEN PLC-RSP-120UC/1AU/SEN PLC-RSP-230UC/1AU/SEN	29 67 37 4 29 67 39 0 29 67 41 3	10 10 10
PLC interface , consisting of base terminal block PLC-BSP...SEN and pluggable miniature relay (see catalog part 6, page 32), for mounting on 	24 V DC 120 V AC/110 V DC 230 V AC/220 V DC ²⁾	equipped with power contact relay PLC-RSP- 24DC/1/SEN PLC-RSP-120UC/1/SEN PLC-RSP-230UC/1/SEN	29 67 36 1 29 67 38 7 29 67 40 0	10 10 10

Technical data

Input data

Nominal input voltage U_N

Permissible input voltage range

Typ. input current at U_N

Typ. response time at U_N

Typ. release time at U_N

Input circuit

24 V DC
120, 230 V AC/DC

24 V DC 120 V AC/
110 V DC 230 V AC/
220 V DC²⁾

see diagram catalog part 6, page 25

9 mA 3.5/3 mA 3 mA

5 ms 6 ms 7 ms

8 ms 15 ms 15 ms

operation indicator, polarity protection diode, damping diode
operation indicator, bridge rectifier

Output data

Contact type

Contact material

Max. switching voltage

Min. switching voltage

Limiting continuous current

Max. inrush current

Min. switching current

Max. power rating, ohmic load:

24 V DC
48 V DC
60 V DC
110 V DC
220 V DC
250 V AC

PLC-R.../1/SEN

Single contact, 1 N/O contact⁵⁾

AgSnO

250 V AC/DC²⁾

12 V AC/DC

6 A

on request

10 mA

140 W

20 W

18 W

23 W

40 W

1500 VA

120 mW

PLC-R.../1AU/SEN

Single contact, 1 N/O contact⁵⁾

AgSnO + 5 μ Au³⁾

30 V AC/36 V DC

100 mV

50 mA

50 mA

1 mA

1.2 W

–

–

–

–

–

100 μ W

Min. switching capacity

General data

Test voltage input/output

Ambient temperature range

Duty type rating

Inflammability class

Mechanical service life

Standards/regulations

4 kV, 50 Hz, 1 min.

– 20 °C to + 55 °C (24 V types to +60 °C)

100 % ED

V0 in acc. with UL 94

10⁷ cycles

IEC 664/IEC 664 A/DIN VDE 0110, contamination class3,

Surge voltage category III, DIN VDE 0160 (in relev. parts),

IEC 255/DIN VDE 0435 (in relev. parts), DIN VDE 0106-101: 1986-11, increased insulation I/O⁴⁾

Installation position/assembly

Type of connection

as desired, in rows with zero spacing

spring cage connection

¹⁾ Further input voltages available on request.

²⁾ For voltages higher than 250 V (e.g. L1, L2, L3) between identical terminal blocks of adjacent modules, the PLC-ATP separating plate (see catalog part 6, page 34) should be installed.

³⁾ If the maximum values indicated are exceeded, the gold layer is destroyed. The values of the AgSnO contact are then valid.

⁴⁾ For protective isolation between identical terminal blocks of adjacent modules, the PLC-ATP separating plate (see catalog part 6, page 34) should be installed.

⁵⁾ N/C contact on request.

Notes:

Type of housing: polyamide PA non-reinforced,
Color: green, see catalog part 6, page 149

Marking systems and mounting material, see catalog part 3/4.

The rated cross section (see catalog part 6, page 151) refers to untreated conductors without ferrules.

For the protection of input and output, inductive loads must be dampened with an effective protection circuit.

Due to the input circuit integrated in the base terminal block (see catalog part 6, page 32), a 60 V relay, REL-MR-60DC/..., is used with the 120 V and 230 V modules.

The PLC-ATP separating plate (see catalog part 6, page 34) must always be installed at the beginning and end of a PLC terminal strip.

PLC Sensor Interface with Optical Coupler – now also with spring cage connection system!

In interface applications between the PLC and sensors, such as proximity switches, limit switches, or auxiliary contacts, often only an N/O function is required. Here, people turn directly to the PLC-OSP...SEN input interface, specially optimized for these applications and consisting of a 6.2 mm base terminal block and pluggable miniature optical coupler. In addition to the proven screw clamp connection version, the sensor interface is now available with **spring cage connections**. The wiring, diagonally from above, is particularly convenient during assembly.

No need for input terminal blocks

Unlike previous input optical couplers, all the sensor connections, including the voltage supply for sensors/switches (!), are connected directly to the PLC sensor interface. PLC-OSP...SEN can thus be used directly as a terminal strip with integrated interface function for the incoming sensor cables, without the need for additional modular terminal blocks. (See also structural diagram in catalog part 6, page 30.)

Assessment of savings:

- Elimination of the costs of two (three) modular terminal blocks for sensor/switch supply, signal and sensor ground (in the case of three-conductor initiators).
- Space savings of approx. 80 %,
- Time saving approx. 60 %,
- Reduction in wiring thanks to plug-in bridges

Optimum use of plug-in bridges.

The sensor interface attains the maximum degree of efficiency with the convenient FBST plug-in bridge system. PLC-OSP...SEN makes effective use of the bridging facilities for the sensor/switch voltage supply, for the supply and sensor ground at the A2 connection, and for the common supply potential of the PLC at connection 13. Especially effective here are the 500 mm long color-insulated continuous bridges that can easily be cut to the required length and inserted in the bridge shafts in a flash. No stripping, no pressing on of ferrules, no connecting. This makes complicated, time-consuming loop bridges a thing of the past!

Assessment of savings:

- Reduction in wiring by eliminating the need for modular terminal blocks and using all bridging facilities: approx. 60 %.

Further advantages:

PLC-OSP...SEN naturally offers the same benefits as all other PLC series with optical coupler:

- Switching capacity of up to 24 V DC/2 A, depending on the type,
- Wear-resistant switching,

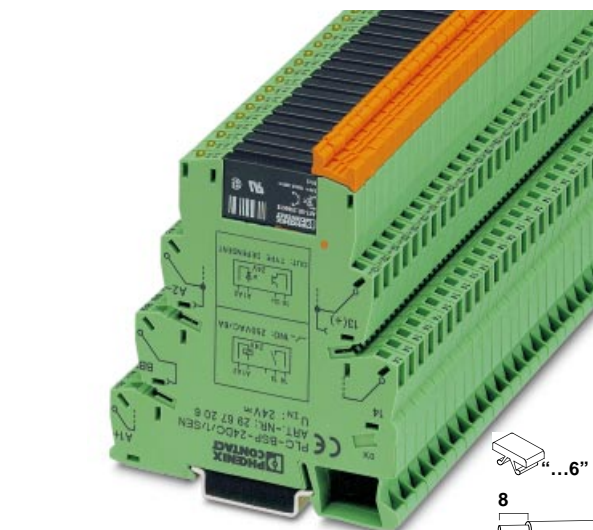

(IEC) [mm ²]	rigid solid	flexible stranded	AWG	I [A]	U [V]
Connection data	0.2-2.5	0.2-1.5	24-14	*	*

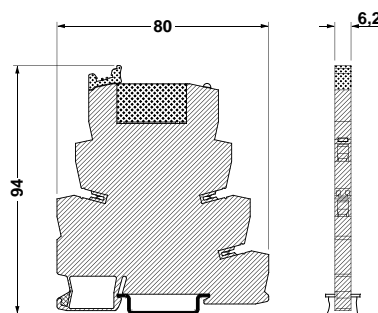
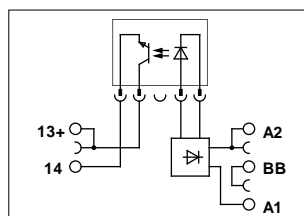

* The electrical data are determined by the relay.



- Integrated input circuit,
- Input or power optical coupler can be supplied,
- IP67-protected fully encapsulated optical electronics,
- Insensitive to vibration and shock,
- User-specific marking
- Inflammability class V0 in acc. with UL94.

PLC Sensor Interface with Optical Coupler

– now also with spring cage connection system!

Description	Input voltage U_N ¹⁾	Type	Order No.	Pcs./ Pkt.
PLC interface , consisting of base terminal block PLC-BSP...SEN and pluggable miniature optical coupler (see catalog part 6, page 33), for mounting on 	24 V DC 120 V AC/110 V DC 230 V AC/220 V DC ²⁾	equipped with input optical coupler PLC-OSP-24DC/48DC/100/SEN PLC-OSP-120UC/48DC/100/SEN PLC-OSP-230UC/48DC/100/SEN	29 67 57 8 29 67 58 1 29 67 59 4	10 10 10
PLC interface , consisting of base terminal block PLC-BSP...SEN and pluggable miniature optical coupler (see catalog part 6, page 33), for mounting on 	24 V DC 120 V AC/110 V DC 230 V AC/220 V DC ²⁾	equipped with power optical coupler PLC-OSP-24DC/24DC/2/SEN PLC-OSP-120UC/24DC/2/SEN PLC-OSP-230UC/24DC/2/SEN	29 67 51 0 29 67 52 3 29 67 53 6	10 10 10
Technical data		Input optical coupler Power optical coupler		
Input data				
Nominal input voltage U_N		24 V DC	120 V AC/ 110 V DC 230 V AC/ 220 V DC ²⁾	24 V DC
Permissible range (in reference to U_N)		0.8-1.2	0.8-1.1	0.8-1.2
Switching level 1 signal ("H")		$0.8 \times U_N$	$0.8 \times U_N$	$0.8 \times U_N$
0 signal ("L")		$0.4 \times U_N$	$0.3 \times U_N$	$0.25 \times U_N$
Typ. input current at U_N		8 mA	4 mA	9 mA
Typ. turn-on time for U_N		20 μ s	6 ms	20 μ s
Typ. turn-off time for U_N		300 μ s	10 ms	500 μ s
Transmission frequency f_{limit}		300 Hz	10 Hz	300 Hz
Input circuit	24 V DC 120, 230 V AC/DC	operation indicator, polarity protection diode, damping diode operation indicator, bridge rectifier		
Output data				
Max. switching voltage		PLC-O.../48DC/100/SEN	PLC-O.../24DC/2/SEN	
Min. switching voltage		48 V DC	33 V DC	
Limiting continuous current		3 V DC	3 V DC	
		100 mA	2 A (see derating curve catalog part 6, page 27)	
Max. inrush current		–	15 A (10 ms)	
Min. switching current		–	–	
Output connection		2-conductor floating	2-conductor floating	
Output circuit		polarity reversal protection and surge voltage protection	surge voltage protection	
Voltage drop at max. limiting continuous current		≤ 1 V	≤ 200 mV	
General data				
Test voltage input/output		2,5 kV, 50 Hz, 1 min.		
Ambient temperature range		– 20 °C to +60 °C		
Duty type rating		100 % ED		
Inflammability class		V0 in acc. with UL 94		
Standards/regulations		IEC 664/IEC 664 A/DIN VDE 0110, contamination class 2, surge voltage protection category III, as desired, in rows with zero spacing		
Installation position/assembly		spring cage connection		
Type of connection				

¹⁾ Further input voltages available on request.

²⁾ For voltages higher than 250 V (e.g. L1, L2, L3) between identical terminal blocks of adjacent modules, the PLC-ATP separating plate (see catalog part 6, page 34) should be installed.

Notes:

Type of housing: polyamide PA non-reinforced,
Color: green, see catalog part 6, page 149

Marking systems and mounting material, see catalog part 3/4.

The rated cross section (see catalog part 6, page 151) refers to untreated conductors without ferrules.

For the protection of input and output, inductive loads must be dampened with an effective protection circuit.

Due to the input circuit integrated in the base terminal block (see catalog part 6, page 33), a 60 V optical coupler, OTP-60DC/..., is used with the 120 V and 230 V modules.

The PLC-ATP separating plate must always be installed at the beginning and end of a PLC terminal strip.

For protective isolation between identical terminal blocks of adjacent modules, the PLC-ATP separating plate (see catalog part 6, page 34) should be installed.

PLC Accessories

Input terminal block PLC-ESK

The 9 mm wide input terminal block PLC-ESK is the same shape as the PLC interface terminal blocks. It is used to feed in bridging potentials. Its nominal current is 32 A! When currents are ≤ 6 A, they can be fed in directly at the connecting terminal blocks of one of the connected PLC interfaces.

Plug-in bridges FBST

The differently colored, insulated plug-in bridges FBST make optimum use of the advantages of PLC interfaces. The 2-position single plug-in bridges FBST 6 are especially suited for bridging a smaller number of modules and residual currents ≤ 6 A. When a circuit is supplied from both sides, they offer the advantage that the circuit can be opened at any point, allowing all the other modules to continue to be supplied at the same time.

The 500 mm continuous plug-in bridge FBST 500 is even more convenient. All bridges are equipped with a

groove which allows them to be removed with a screwdriver.





If bridges with different potentials meet in neighboring functional blocks, the separating plate PLC-ATP should be placed between them.

Separating plate PLC-ATP

The PLC-ATP separating plate must always be installed at the beginning and end of a terminal strip.

In addition to pure visual separation of functional blocks, it is also necessary in certain cases to place the separating plate between adjacent PLC interface terminal blocks, e.g. when 3 phases (L1, L2, L3) are used on the contact side of the PLC relay terminal blocks.

PLC-ATP is equipped with prescored break-out points at the bridging positions, so that individual bridges can pass through if necessary.

Description	Type	Order No.	Pcs./ Pkt.
Input terminal block , for the input of up to four potentials, for mounting on  Technical data Connection cross section: solid 0.2-4 mm ² stranded 0.2-4 mm ² AWG 24-10 Max. current 32 A Max voltage 250 V AC ¹⁾ Terminal block dim.: same shape as PLC standard series, terminal block width 9 mm Color gray 	PLC-ESK GY	29 66 50 8	5
Cont. plug-in bridge , 500 mm long, insulated, can be cut to any length, for power distribution with PLC... red blue gray 	I _{max} : 32 A FBST 500-PLC RD FBST 500-PLC BU FBST 500-PLC GY	29 66 78 6 29 66 69 2 29 66 83 8	20 20 20
Plug-in bridge, 2-pos. , 6 mm long, insulated, for power distribution with PLC red blue gray 	I _{max} : 6 A FBST 6-PLC RD FBST 6-PLC BU FBST 6-PLC GY	29 66 23 6 29 66 81 2 29 66 82 5	50 50 50
Separating plate , 2 mm thick, should be installed at the start and end of a PLC terminal strip. Furthermore, it is used for: – visual separation of groups, – protective separation of different voltages of neighboring PLC interfaces in acc. with DIN VDE 0106-101, – separation of neighboring bridges with different potentials, – separation of PLC interfaces with voltages > 250 V Color: black 	PLC-ATP BK	29 66 84 1	25

Headquarters: © Phoenix Contact GmbH & Co. KG • Flachsmarktstraße 8-28 • 32825 Blomberg • Germany
 Phone +49-(0) 52 35-3-00 • Fax +49-(0) 52 35-3-4 12 00 • <http://www.phoenixcontact.com>

PLC Labelling ZB 6

Zack strip ZB 6

This marking system combines the advantage of easy handling with the advantage of a reasonable price. The zack strip consists of 10 individual labels which are joined together and can be easily separated at any point. For marking equipment, the labels can be clicked into the marker groove of the engagement lever.

The system advantage: economical, quick, optimum appearance.

In addition to the standard color white, the Zack strip can also be supplied in other colors (see catalog part 3, page 36). Marking is either done manually with the M-PEN or elegantly with the computer marking system CMS. Alternatively, the labels can be ordered pre-printed with numbers, symbols or PLC input and output numbers.

Description	Type	Order No.	Pcs./ Pkt.
Zack strip, unprinted: 10-section, for individual labelling with marker pen or CMS system, sufficient for labelling 100 PLC interface terminal blocks	ZB 6: UNPRINTED	10 51 00 3	10
as above, however, large batch, sufficient for labelling 1000 PLC interface terminal blocks	ZB 6/WH-100: UNPRINTED	50 60 93 5	100
Zack strip, printed horizontally: ²⁾ 10-section with consecutive numbers 1-10 11-20 etc. to 991-1000	ZB 6, LGS: CONSEC. NUMBERS ZB 6, LGS: 1-10 ZB 6, LGS: 11-20 etc. to ZB 6, LGS: 991-1000	10 51 01 6	10
Zack strip, printed horizontally: ²⁾ 9-section with the numbers 1-9	ZB 6, LGS: 1-9	10 51 12 6	10
Zack strip, printed horizontally: ²⁾ 10-section with identical numbers 1/1/1 2/2/2 etc. to 100/100/100	ZB 6, LGS: IDENTICAL NOS. ZB 6, LGS: 1 ZB 6, LGS: 2 etc. to ZB 6, LGS: 100	10 51 03 2	10
Zack strip, printed horizontally: ²⁾ 10-section L1, L2, L3, N, PE, L1, L2, L3, N, PE U, V, W, N, \downarrow , U, V, W, N, \downarrow	ZB 6, LGS: L1-N, PE ZB 6, LGS: U-N	10 51 41 4 10 51 43 0	10 10
Zack strip, printed vertically: ²⁾ 10-section with consecutive numbers 1-10 11-20 etc. to 991-1000	ZB 6, QR: CONSEC. NUMBERS ZB 6, QR: 1-10 ZB 6, QR: 11-20 etc. to ZB 6, QR: 991-1000	10 51 02 9	10
Zack strip, printed vertically: ²⁾ 10-section with identical numbers 1/1/1 2/2/2 etc. to 100/100/100	ZB 6, QR: IDENTICAL NOS. ZB 6, QR: 1 ZB 6, QR: 2 etc. to ZB 6, QR: 100	10 51 04 5	10
Zack strip, printed vertically: ²⁾ 10-section with PLC input numbers e.g.: I 0.0 to I 0.7 (to max. E 127.7)	ZB 6, QR: PLC INPUT...¹⁾	10 51 45 6	10
Zack strip, printed vertically: ²⁾ 10-section with PLC output numbers e.g.: O 0.0 to O 0.7 (to max. A 127.7)	ZB 6, QR: PLC OUTPUT...¹⁾	10 51 44 3	10
Zack strip, special printing. 10-section, divisible, marked according to customer requirements	ZB 6: SO/CMS...³⁾	10 50 49 9	1

¹⁾ Please specify the required marking with order.

²⁾ 10 identically marked strips form a packing unit (PU).

³⁾ Please specify the required marking and color with order.

Marking direction: horizontal "LGS" or vertical "QR", see catalog part 3/4.