Si57x/598/599 ANY FREQUENCY I²C PROGRAMMABLE XO/VCXO EVALUATION BOARD

Description

This document describes the operation of the Silicon Laboratories Si57x/598/599 evaluation kit. The Si57x-EVB kit refers to the evaluation board hardware and software intended for customer evaluation of the Si57x/598/599 any frequency I²C programmable XO/VCXO. The Si57x-EVB kit contains the following:

Kit Contents

- Hardware
 - Motherboard (MB)—silkscreen labeled as "Si5xx Programmable Oscillator"
 - Daughterboard (DB)—silkscreen labeled as "Si5xx CEB DB"
- Software
 - Programmable Oscillator Software
 - Register Programmer
 - EVB Driver (USBXpress[®])

The Si57x motherboard is normally operated together with a Si57x daughterboard populated with an Si570/571/598/599. This combination is referred to as the Si57x-EVB assembly that is also used to evaluate the Si598/599 any frequency I²C programmable XO/VCXOs. Software is supplied for evaluation of the Si57x/598/599 device. All Si570 and Si598 XOs are pin and register compatible. The Si571 and Si599 VCXOs are pin and register compatible. The Si57x-EVB supports all configurations of these devices. The software components run on a USB-equipped PC and are described in detail in "4. Software Installation" on page 12.

Note: Si57x/598/599 samples must be ordered separately from the Si57x-EVB.

Features

- Evaluation of Silicon Laboratories' Si57x/598/599 any frequency I²C programmable XO/VCXO
- Windows-compatible software control and device programming
- Voltage regulator supports at +1.8, +2.5, or +3.3 V
- I²C communication options are jumper configurable
- Voltage control (V_C) input port (Si571/599)

Quick Start

1. Install an assembled Si57x Daughterboard on to the Si57x Motherboard.
2. Verify Si57x Motherboard jumper settings are correct. (The default installation assumes a 3.3V OE active high DUT. Otherwise refer to Table 3.)
3. Connect the USB cable from the EVB to the host PC.
4. Install the EVB Driver on the host PC.
5. Install the Programmable Oscillator Software from the CD or zip file.
6. Launch the Programmable Oscillator Software by clicking **Start**→**Programs**→**Silicon Laboratories**→**Programmable Oscillator Software** and selecting one of the applications.

Note: The above instructions assume an assembled daughterboard is available. If it is not available, install the Si57x/598/599 DUT and place proper output components on the daughterboard as described in "1.9. Si57x Daughterboard" on page 9.

Si57x-EVB

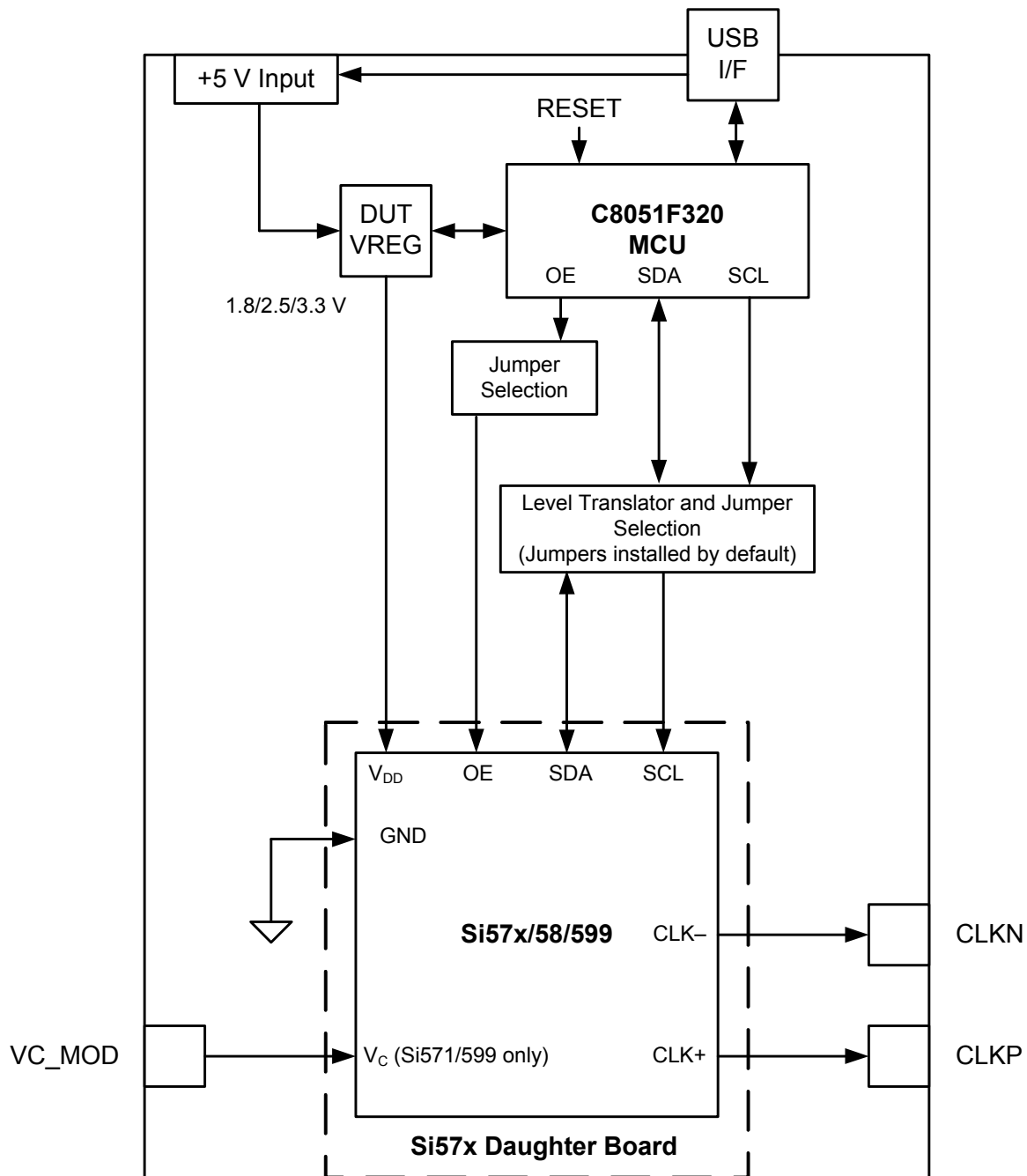

Figure 1. Si57x-EVB Functional Block Diagram

1. Functional Description

The Si57x-EVB is the evaluation board assembly for the Si57x/598/599 any frequency I²C programmable XO/VCO. This evaluation board assembly provides access to all signals for programming and operating the device.

The Si57x-EVB assembly motherboard and daughterboard schematics, bills of material, and PCB layouts are appended as sections 5, 6 and 7, respectively. Reference designators below refer to the Si57x-EVB motherboard unless otherwise noted. The Si57x-EVB is oriented with the daughterboard at the bottom in the directions below.

1.1. Motherboard-Daughterboard Connection

The Si57x-EVB motherboard connects to the Si57x daughterboard at connectors J13-J14. Each of these is a 2x20 pin, impedance controlled connector. The connectors are keyed so there is only one proper way to install the board. Orient the boards on installation so that the silkscreen triangle on the daughterboard matches the silkscreen on the motherboard.

1.2. Power Supply

The Si57x-EVB is pre-configured to accept 5 V from the USB connector at J15. To change the board's 5 V power supply from the USB connection to the terminal block at J18, make these changes:

- Remove R7.
- Populate R8.

Note: If both R7 and R8 are installed, do not simultaneously connect to both the USB connector at J15 and to a separate 5 V supply at J18. Otherwise, power supply contention may occur.

Typical supply current draw for the Si57x-EVB assembly (motherboard + daughterboard) is approximately 230 mA. See the device data sheet for device power consumption specifications.

The evaluation daughter board are designed to operate at any of the following nominal voltages: 1.8, 2.5, or 3.3 V. The Si57x-EVB has an on-board voltage regulator which supplies any of these voltages. The Si57x-EVB voltage regulator is controlled via jumpers. By default, a jumper is installed, selecting 3.3 V for the Si57x/598/599. Alternatively, VREG may be set to 1.8 or 2.5 V per Table 1.

Table 1. VREG Jumpers

Voltage Selection	J6 Jumper Installation (Assuming S/W Control Unavailable)
3.3	Connect pin 1 "3.3 V" to center pin 2
2.5	Connect pin 3 "2.5 V" to center pin 2
1.8	No jumper

Si57x-EVB

1.3. Reset Circuit

The Si57x-EVB MCU may be reset by pressing momentary pushbutton SW1. It may also be held in reset by installing a jumper at J7. MCU outputs are open drain and are tri-stated during reset. They remain tri-stated unless otherwise directed under program control.

There is no hardware reset for the Si57x/598/599 itself. The Si57x/598/599 is reset only on power-up or through software. Pressing the Si57x-EVB motherboard pushbutton SW1 in an attempt to reset the Si57x/598/599 may result in unexpected behavior.

1.4. USB

A 4-pin USB receptacle is provided at location J15. The Si57x-EVB, via the MAC's USB Function Controller, is compatible with USB Specification 2.0. When the USB link is in use the MCU drives LED D7.

1.5. MCU

The MCU, Silicon Laboratories P/N C8051F320, provides the following functions:

- Supports I²C communication to the DUT on behalf of the host PC per the Si57x-EVB software
- Drives a number of status indicator LEDs (see Table 2)
- Supplies 3.3 V to peripheral ICs on the motherboard but not to the DUT

The MCU comes pre-loaded with firmware. While there is a provision for in-circuit programming at connector J12 located on the back, this should not be necessary. The host PC operates the Si57x/598/599 software and communicates to the Si57x/598/599 through the MCU via USB connector J15. When the USB link is in use, LED D7 should be illuminated.

As mentioned earlier, the MCU may be reset by pressing momentary pushbutton (SW1) or held in reset by installing a jumper at J7.

1.5.1. Status Signals

There are seven LEDs on the Si57x-EVB that report visual status as listed in Table 2 and as highlighted in Figure 2. Upon power up, D1–D2 and only one of D3–D5 should be illuminated. D6 and D7 are only illuminated when in use.

Table 2. Si57x-EVB LEDs

Reference Designation	Color	Signal or Status Indicated	Comments
D1	Red	5 V present	Connected to filtered 5 V
D2	Red	MCU 3.3 V present	Connected to MCU 3.3 V output
D3	Red	VREG 3.3 V selected	
D4	Red	VREG 2.5 V selected	
D5	Red	VREG 1.8 V selected	
D6	Green	OE active	
D7	Green	USB active	Under MCU control

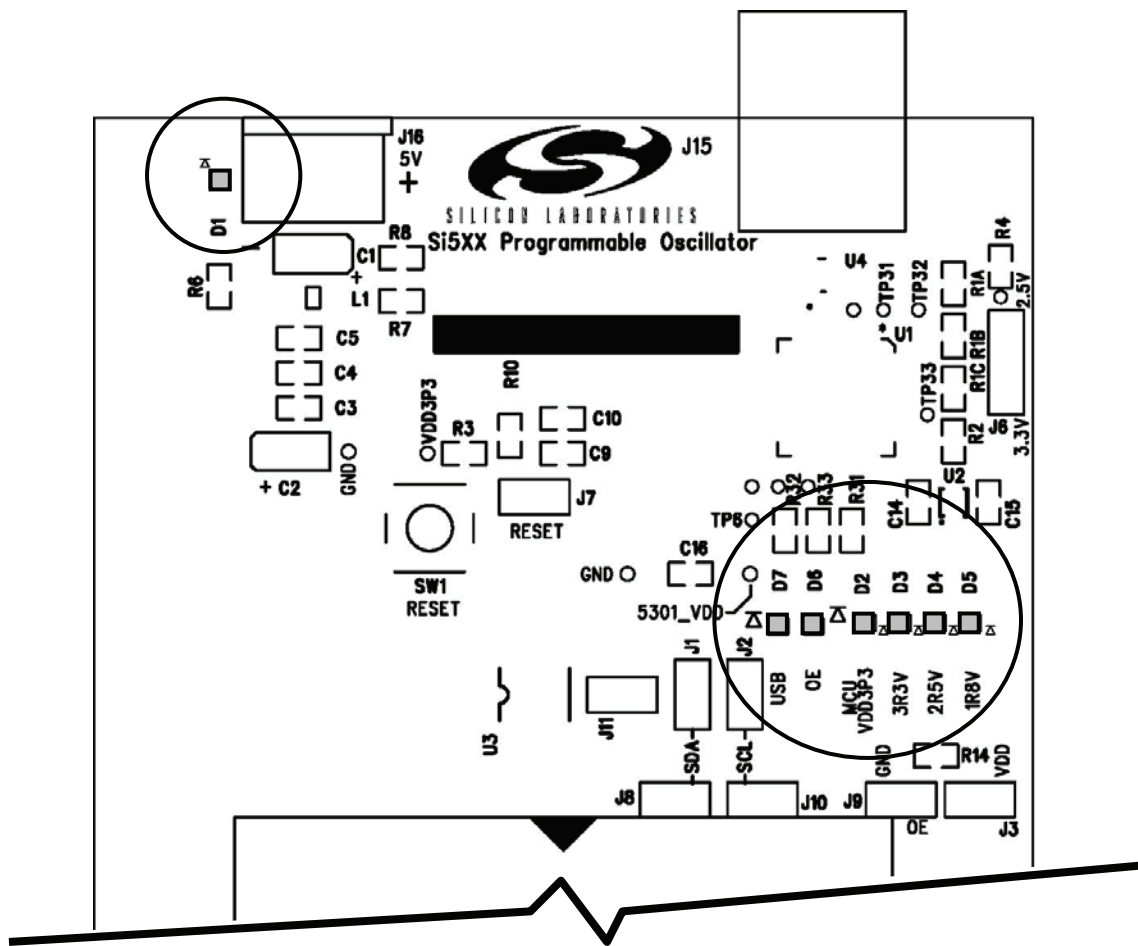

Figure 2. Si57x-EVB Motherboard LED Locations

Si57x-EVB

1.5.2. Jumpers

There are eight jumper locations on the Si57x-EVB as listed in Table 3. (The reference designations J4-J5 and J16-17 are assigned to other connector types.) The default or pre-loaded jumpers are shown in Figure 3.

Table 3. Si57x-EVB Jumpers

Reference Designation	Configuration	Signals	Default (Pre-loaded) Jumper Installation
J1	1X2	Bypasses U3 level translator. Connects signal MCU_SDA to signal 57x_SDA.	Installed Supports DUT_VDD = 2.5 or 3.3 V nominal.
J2	1X2	Bypasses U3 level translator. Connects signal MCU_SCL to signal 57x_SCL.	Installed Supports DUT_VDD = 2.5 or 3.3 V nominal.
J3	1X2	Disables OE active low signal. See "1.7. Si57x/598/599 Digital Control Signals" on page 8.	Not installed
J6	1X3	Selects voltage regulator output supplying DUT_VDD. See "1.2. Power Supply" on page 3 and Table 1 on page 3.	Installed in 3.3 V position. Ready for MCU control. (Default voltage selection is 1.8 V if no jumper is installed.)
J7	1X2	Reset	Not installed
J8	1X2	57x SDA test pins only.	Not installed
J9	1X2	Disables OE active high signal. See "1.7. Si57x/598/599 Digital Control Signals" .	Not installed
J10	1X2	57x SCL test pins only.	Not installed
J11	2X3	Disables U3 level translator.	Installed Supports DUT_VDD = 2.5 or 3.3 V nominal.

1.6. Si57x/598/599 I²C Communication Configuration

The Si57x/598/599 supports I²C serial communication through the SDA and SCL pins. All Si570 and Si598 XOs are pin and register compatible, and all Si571 and Si599 VCXOs are pin and register compatible. The device can be operated as an I²C slave only. The MCU supports I²C communication to the DUT. The Si57x-EVB must be configured by jumpers as described below to select the intended I²C communications path depending on the DUT's nominal supply voltage.

For I²C communication with the Si57x/598/599 DUT = 2.5 or 3.3 V nominal, there must be jumpers installed at J1, J2, and J11 pin 2. This defeats and bypasses the installed bidirectional voltage level translator at U3.

(For I²C communication with the Si57x/598/599 DUT at 1.8 V nominal supply, please consult the factory.)

1.7. Si57x/598/599 Digital Control Signals

There is one normally static digital input control signal that routes to the Si57x/598/599: Output Enable or OE. By default, the OE signal is pulled HIGH on the Si57x-EVB and may be pulled low by installing a jumper at J9.

To support OE active LOW control, make the following changes to the Si57x motherboard:

- Install R9.
- Remove R14.

You can then selectively disable the OE active LOW by installing a jumper at J3. See Figure 4 for the location of these components.

1.8. Si57x/598/599 Voltage Control Signal

An external voltage control signal may be applied to the control voltage modulation input at SMA connector J17, silkscreen designation VC_MOD). This voltage supplies the control voltage or voltage modulation input to an Si571 when installed on the DB. No jumper changes are required to support the Si570/598 versus the Si571/599. Pin 1 on the Si571 is the V_C pin and is a N/C for the Si570.

1.9. Si57x Daughterboard

The Si57x daughterboard can accommodate either Si570/571/598/599 devices and supports all output formats. All Si570 and Si598 XOs are pin and register compatible, and all Si571 and Si599 VCXOs are pin and register compatible. Typically, the boards are shipped without the sample device or any output components. Table 4 lists suggested output loading options for different output formats and coupling configurations.

Table 4. Si57x Daughterboard Output Loading Options

Output Format	Config	REF DES Location	Value	Comments
CML	AC coupling only	C2,C3	0.1 μ F	ac coupling capacitors
CMOS	Near end load on board	J3	CONN, HEADER, 2X1	High Z probe test point
		R3	15 pF	Install 0603 load capacitor at resistor location.
	Far end load off board	C3	33–50 Ω	Install 0603 source impedance matching resistor at capacitor location for driving transmission line.
LVDS	AC coupling	C2, C3	0.1 μ F	ac coupling capacitors
	DC coupling	C2, C3	0 Ω	Install 0603 resistors at cap locations.
LVPECL	AC coupling	C2, C3	0.1 μ F	ac coupling capacitors
		R2, R3	130–150 Ω	Local bias resistors
	DC coupling	C2, C3	0 Ω	Install 0603 resistors at cap locations.

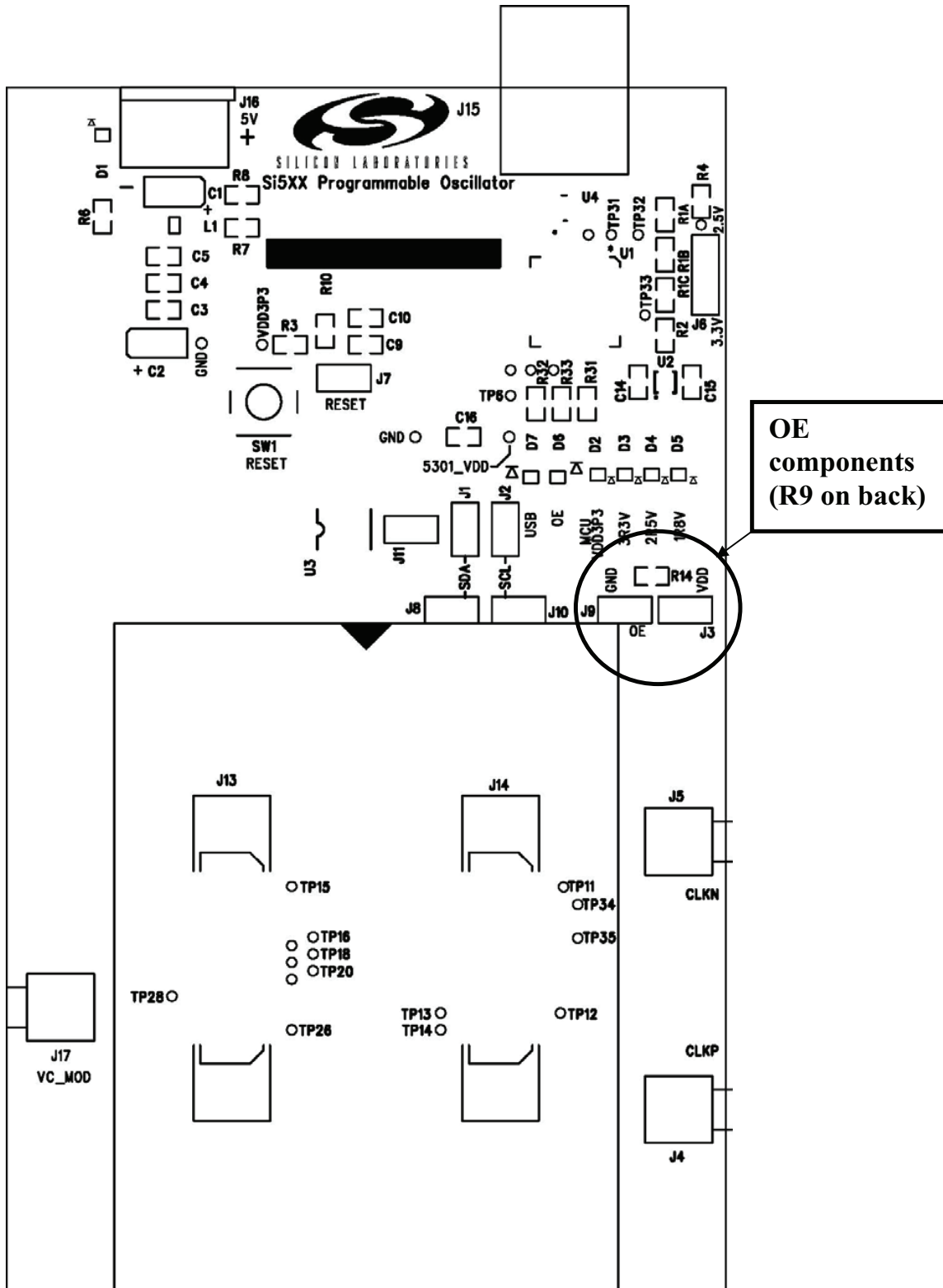

Figure 4. Si57x-EVB Motherboard Default Jumper Locations

2. Clock I/O

There are no input clock signals that are routed to and from the DUT via the motherboard. The Si57x daughterboard output clocks are directly routed from the Si57x daughterboard to SMA connectors J4 and J5. These connectors are designated CLKP and CLKN, respectively. Each of these output clocks needs to be terminated into $50\ \Omega$ single-ended, $100\ \Omega$ differential. Any ac coupling caps or near end LVPECL bias resistors have to be provided for on the Si57x daughterboard.

3. Configuring the Si57x-EVB

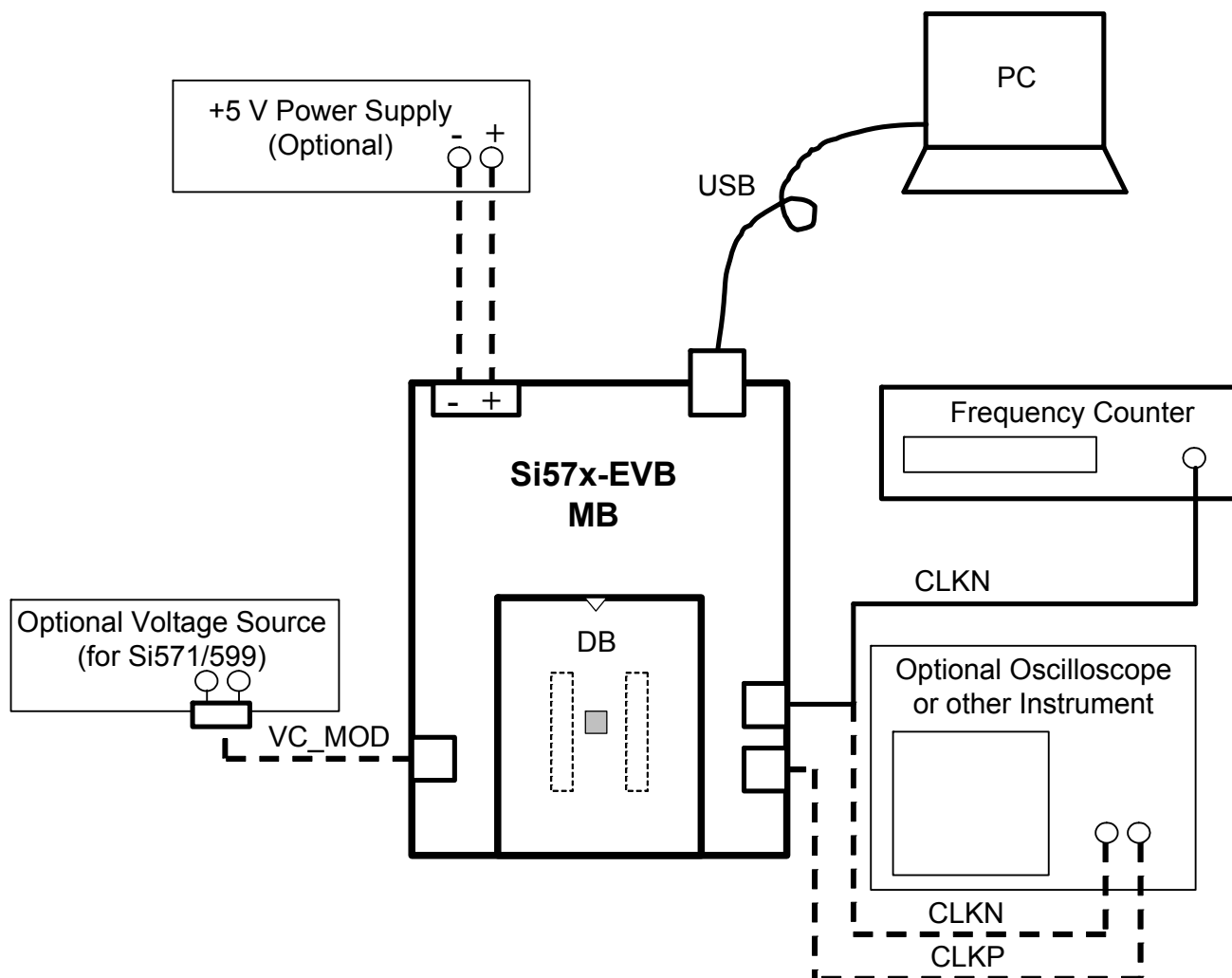

Figure 5. Typical Configuration

4. Software Installation

The following sections describe how to install and begin using the software. There is also a readme.txt file with the installation files and a detailed online help file with the actual installed programs which contain additional information. The latest Programmable Oscillator Software is available online at <http://www.silabs.com>.

4.1. PC System Requirements

- Microsoft Windows 2000 or Windows XP
- USB 2.0
- 1 MB of free hard drive space
- 1024 x 768 screen resolution or greater (1280 x 1024 recommended)
- Microsoft .NET Framework 1.1
- EVB Driver (USBXpress)

Note: The EVB driver is provided with the installation files.

4.2. Microsoft .NET Framework Installation

The Microsoft .NET Framework is required before installing and running the software. Details and installation information about the .NET Framework are available via a shortcut in the NETFramework directory or at the following web site:

<http://www.microsoft.com/downloads/details.aspx?FamilyId=262D25E3-F589-4842-8157-034D1E7CF3A3&displaylang=en>

Contact your system administrator for more details.

4.3. EVB Driver (USBXpress®) Installation

1. Connect the USB cable to the PC.
2. The operating system will recognize the new USB device.
3. The operating system will start the Install New Device Driver wizard. Select "Install from a list or specific location (Advanced)" and click **Next**.



Figure 6. USBXpress Driver Installation for Windows XP—Options

4. Select "Include this location in the search:" and click **Browse** to select the "USBXpressDriver" directory on the CD-ROM drive. Click **Next**.

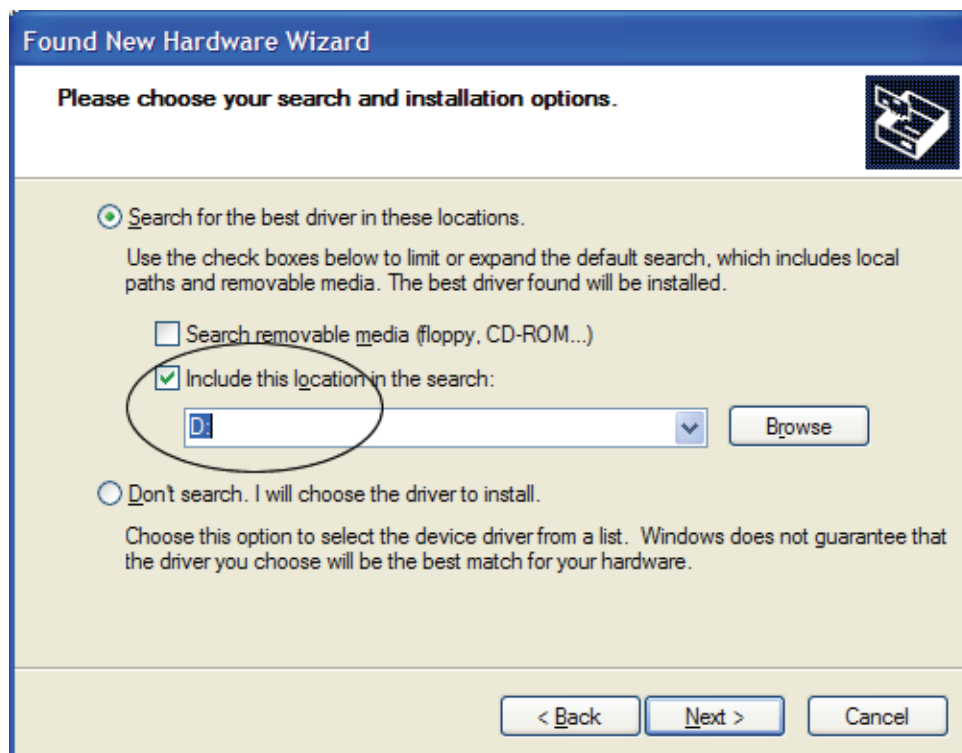

Figure 7. USBXpress Driver Installation for Windows XP—Location

5. The operating system will install the driver. Click **Finish** in the last wizard window.

Verify the driver is installed by opening the Device Manager and expanding the "Universal Serial Bus controllers" section. The USBXpress entry should exist as shown in the figure. This entry appears only when the board is connected to the PC via USB, and powered on.

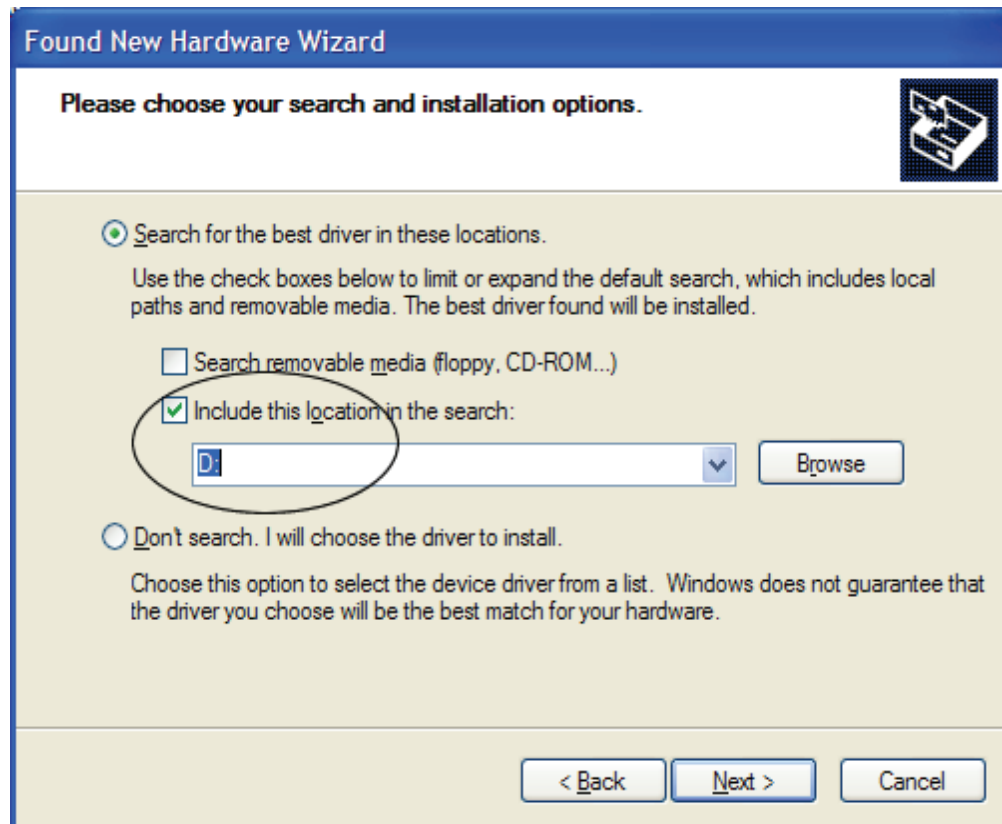

Figure 8. USBXpress Driver Entry in the Device Manager

4.4. EVB Software Installation

The software may be installed from a CD packaged with the EVB kit. This software may also come via a zip file. The installation is similar regardless of how the software is distributed.

To install:

1. Navigate to the **Software** directory.
2. Double-click on the **Setup.exe** file.
3. Follow the steps in the wizard to install the program.
Note: Use the default installation location for best results.
4. After the installation is complete, click on **Start**→**Programs**→**Silicon Laboratories**→**Programmable Oscillator Software**. Select one of the programs to control the EVB and device.
5. Refer to the online help in each program by clicking **Help**→**Help** in the menu.

To uninstall:

1. Open **Add/Remove Programs** in the Windows' Control Panel.
2. Select **Programmable Oscillator Software** in the list.
3. Click **Remove**.
4. Follow the steps in the Wizard for complete removal.

4.5. EVB Software Description

These programs are available by clicking **Start**→**Programs**→**Silicon Laboratories**→**Programmable Oscillator Software**. Refer to the online help by clicking **Help**→**Help** in the menu of each program to get more detailed information on how to use the software.

Program	Description
Programmable Oscillator Calculator	The Programmable Oscillator Calculator provides a tutorial-like, high-level interface to using the oscillator. After specifying the frequencies and I ² C address, the software will automatically determine the new configuration and program the device.
Register Programmer	The Register Programmer provides low-level control of the oscillator with individual register and bit access.

5. Schematics

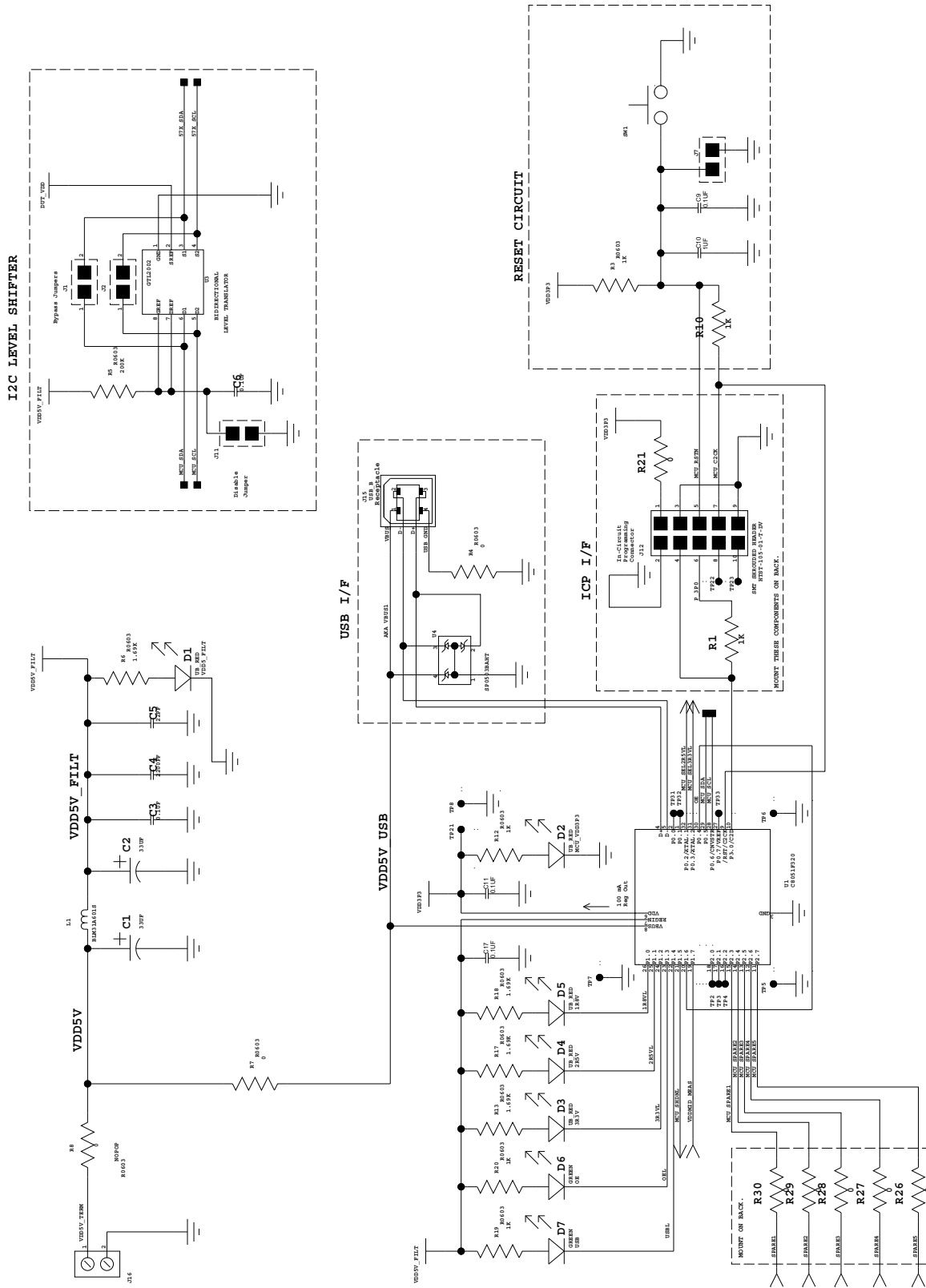

Figure 9. Si57x-EVB Motherboard Schematic (Page 1)

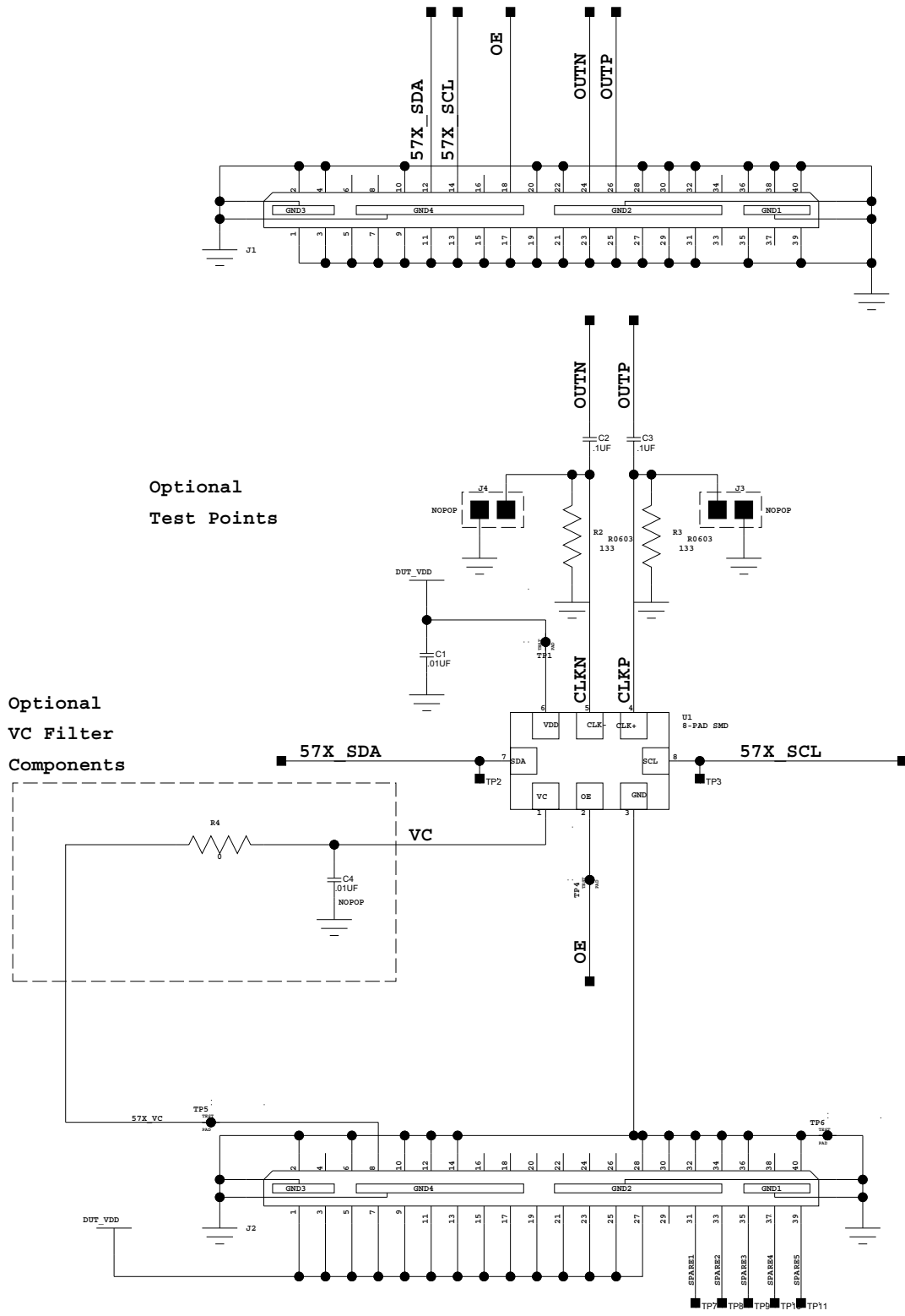

Figure 11. Si57x-EVB Daughterboard Schematic

6. Bill of Materials

6.1. Si57x-EVB Motherboard

Item	QTY	REFERENCE	Description	Part Number	Manufacturer
1	2	C1,C2	CAP,SM,33UF,6.3V,10%,TANTALUM,3528	TA006TCM336KBR	VENKEL
2	7	C3,C6,C9,C11,C14,C15,C17	CAP,SM,0.1UF,16V,20%,X7R,0603	C0603X7R160-104KNE	VENKEL
3	1	C4	CAP,SM,2200PF,16V,10%,X7R,0603	C0603X7R160-222KNE	VENKEL
4	1	C5	CAP,SM,22PF,50V,10%,C0G,0603	C0603C0G500-220KNE	VENKEL
5	2	C10,C16	CAP,SM,1UF,6.3V,X7R,0603	C0603X7R6R3-105KNE	VENKEL
6	5	D1,D2,D3,D4,D5	LED,SM,LN1271,BRIGHT RED	LN1271RAL-TR	PANASONIC
7	2	D6,D7	LED,SM,LN1371G,GREEN	LN1371G	PANASONIC
8	8	J1,J2,J3,J7,J8,J9,J10,J11	CONN,HEADER,2X1	2340-6111TN or 2380-6121TN	3M
9	3	J4,J5,J17	CONNECTOR,SMA,RA	142-0701-301	JOHNSON
10	1	J6	CONN,HEADER,3X1	2340-6111TN or 2380-6121TN	3M
11	1	J12	CONN,SM,2X5	HTST-105-01-T-DV	SAMTEC
12	2	J13,J14	CONN,SM,40POS	QSE-020-01-L-D-A-GP	SAMTECH
13	1	J15	CONN,USB,B,RECEPT	897-30-004-90-000000	MILL-MAX
14	1	J16	CONN,POWER,2 POSITION	506-5ULD02	Mouser
15	1	L1	FERRITE,SM,600 OHM,1500MA	BLM31P601SGPT	Murata
16	9	R1,R3,R9,R10,R12,R14,R15,R16,R19,R20	RES,SM,1K,1%,0603	CR0603-16W-1001FT	VENKEL
17	1	R1A	RES,SM,47.5K,1%,0603	CR0603-16W-4752FT	VENKEL
18	1	R1B	RES,SM,95.3K,1%,0603	CR0603-16W-9532FT	VENKEL
19	1	R1C	RES,SM,44.2K,1%,0603	CR0603-16W-4422FT	VENKEL
20	1	R2	RES,SM,165K,1%,0603	CR0603-16W-1653FT	VENKEL
21	9	R4,R7,R8,R21,R26,R27,R28,R29,R30	RES,SM,0,0603	CR0603-16W-000T	VENKEL
22	1	R5	RES,SM,200K,1%,0603	CR0603-16W-2003FT	VENKEL
23	4	R6,R13,R17,R18	RES,SM,1.69K,1%,0603	CR0603-16W-1691FT	VENKEL
24	1	R31	RES,SM,4.75K,1%,0603	CR0603-16W-4751FT	VENKEL
25	2	R32,R33	RES,SM,10K,1%,0603	CR0603-16W-1002FT	VENKEL
26	1	SW1	SWITCH,PUSH BUTTON, MINIATURE	101-0161	MOUSER
27	1	U1	IC,SM,MCU,32 POS,QFN	C8051F320	SILICON LABORATORIES
28	1	U2	IC,SM,LINEAR REGULATOR,6 POS, DFN	LTC3025EDC	LINEAR TECH
29	1	U3	IC,SM,BI-DIRECTIONAL VOLTAGE TRANSLATOR	GTL2002D/G-T	PHILIPS
30	1	U4	IC,SM,DIODE ARRAY, 6 POS,SOT143	SP0503BAHT	LITTLEFUSE
31	1	Z1	DIODE,SM,ZENER,3.6V	1SMA5914BT3	ON SEMI

6.2. Si57x-EVB Daughterboard

Item	QTY	REFERENCE	Description	Part Number	Manufacturer
1	1	C1	CAP,SM,0.01UF,16V,10%,X7R,0603	C0603X7R160-103KNE	VENKEL
2	2	J1,J2	CONN,HIGH SPEED HEADER,40POS,SM	QTE-020-01-L-D-A-GP	SAMTECH
3	1	R4	RES,SM,0,0603	CR0603-16W-000T	VENKEL
No Load					
4	2	C2,C3	CAP,SM,0.1UF,16V,20%,X7R,0603	C0603X7R160-104KNE	VENKEL
5	1	C4	CAP,SM,0.01UF,16V,10%,X7R,0603	C0603X7R160-103KNE	VENKEL
6	2	J3,J4	CONN,HEADER,2X1	2340-6111TN or 2380-6121TN	3M
7	2	R2,R3	RES,SM,133,1%,0603	CR0603-16W-1330FT	VENKEL
8	1	U1	ANY-RATE I2C PROGRAMMABLE XO/VCXO	XO = Si570, VCXO = Si571	SILICON LABORATORIES

Si57x-EVB

7. Layout

7.1. Si57x-EVB Motherboard

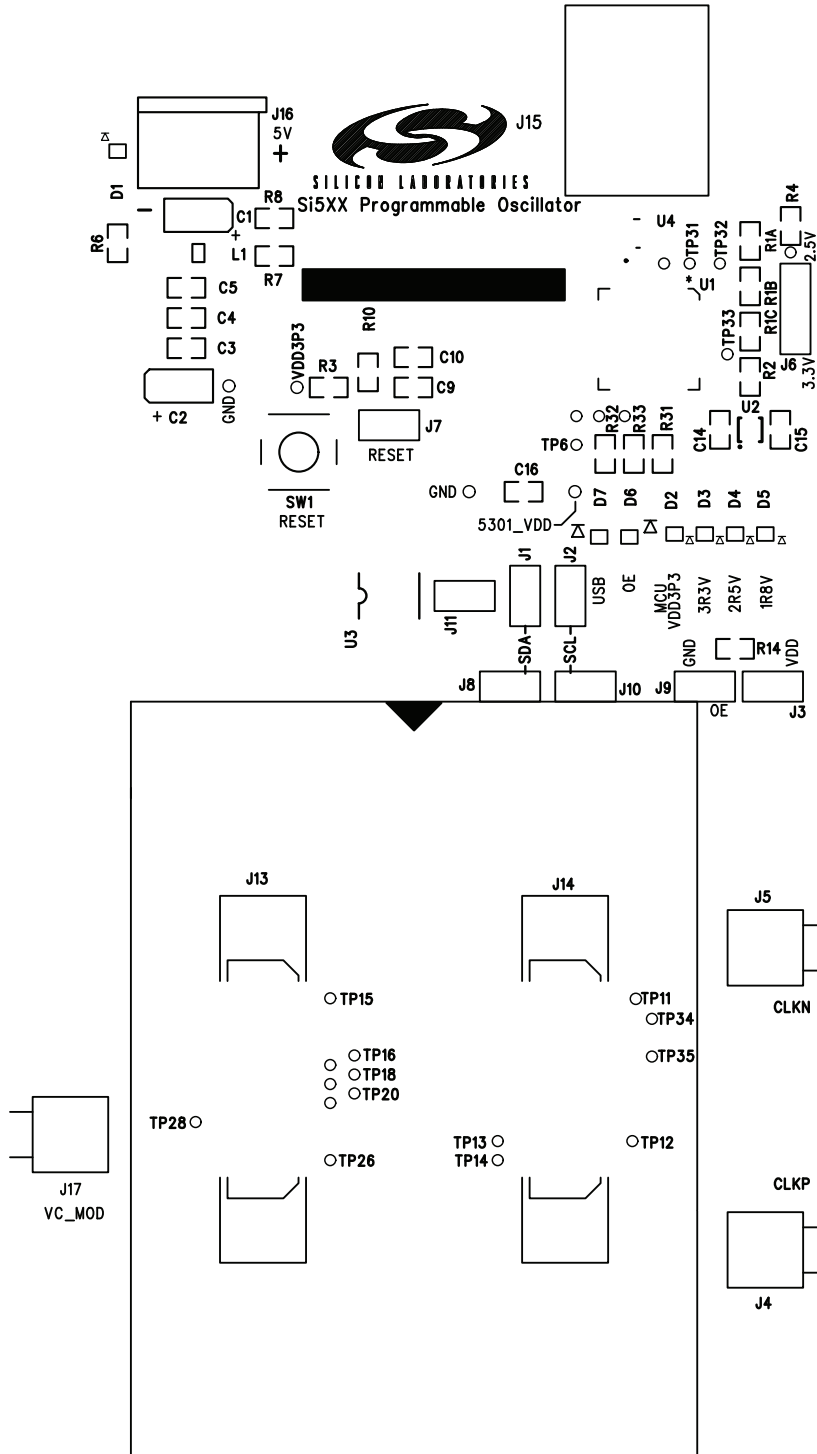

Figure 12. Si57x-EVB-MB Silkscreen Side A

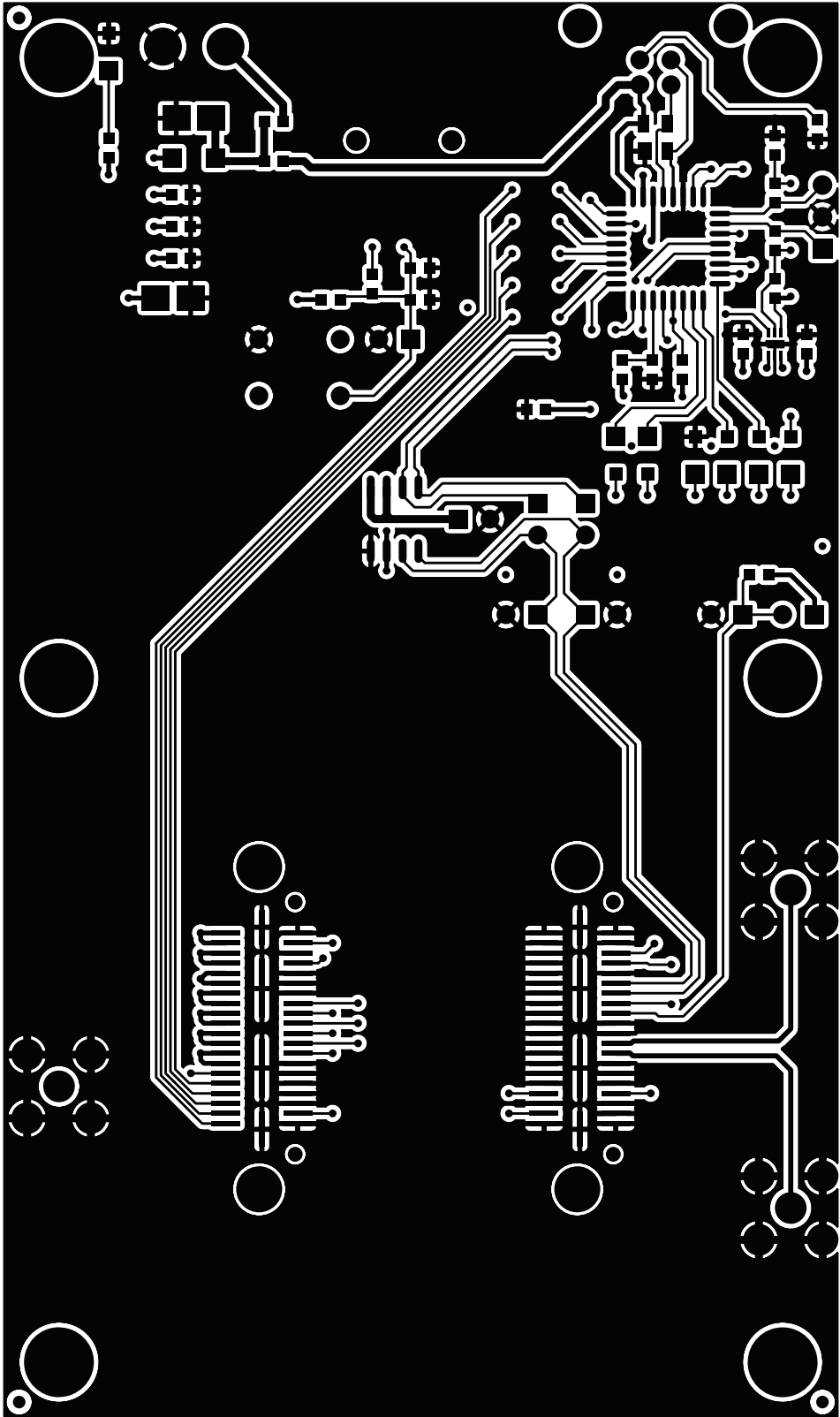

Figure 13. Si57x-EVB-MB Primary Side

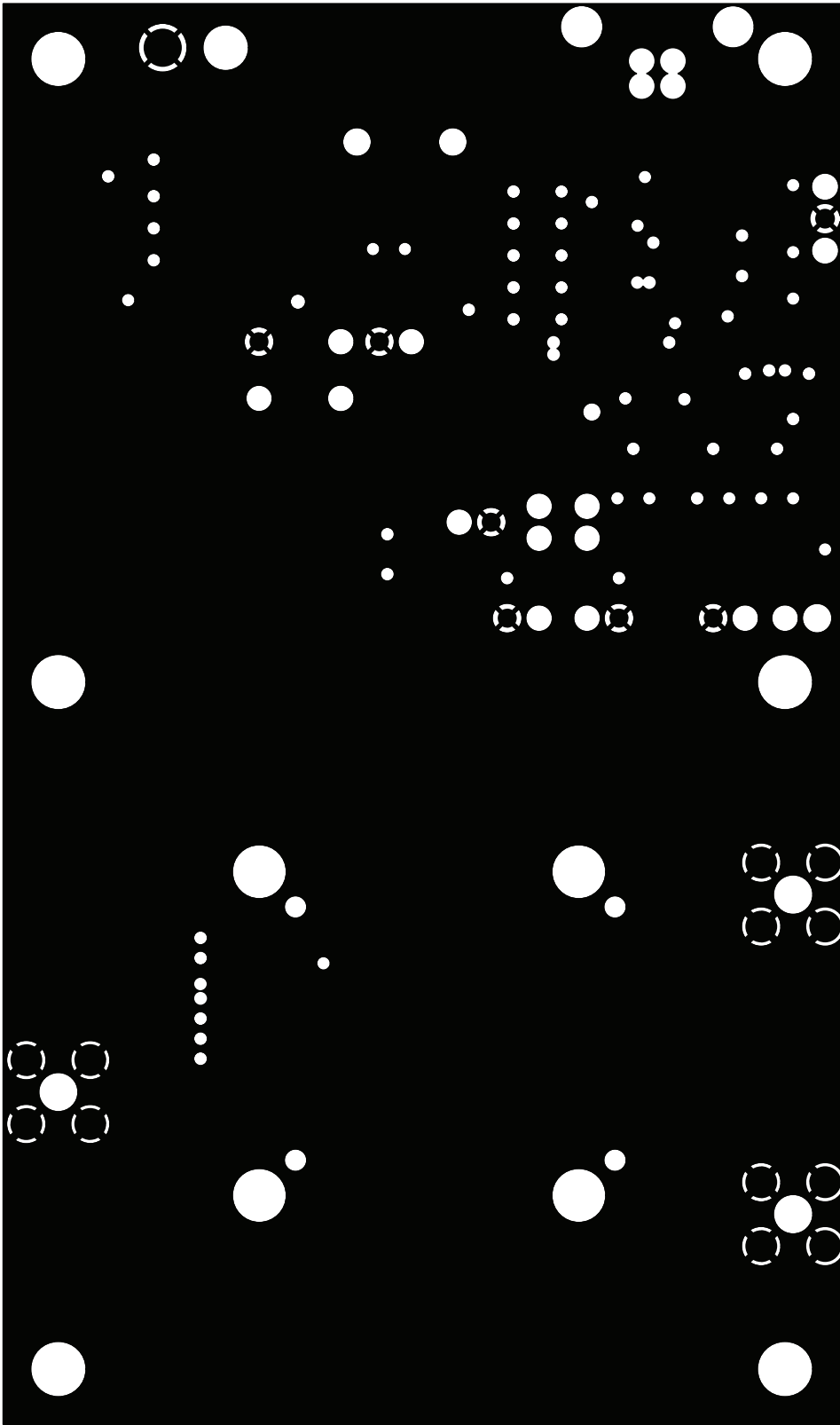

Figure 14. Si57x-EVB-MB GND Plane 1

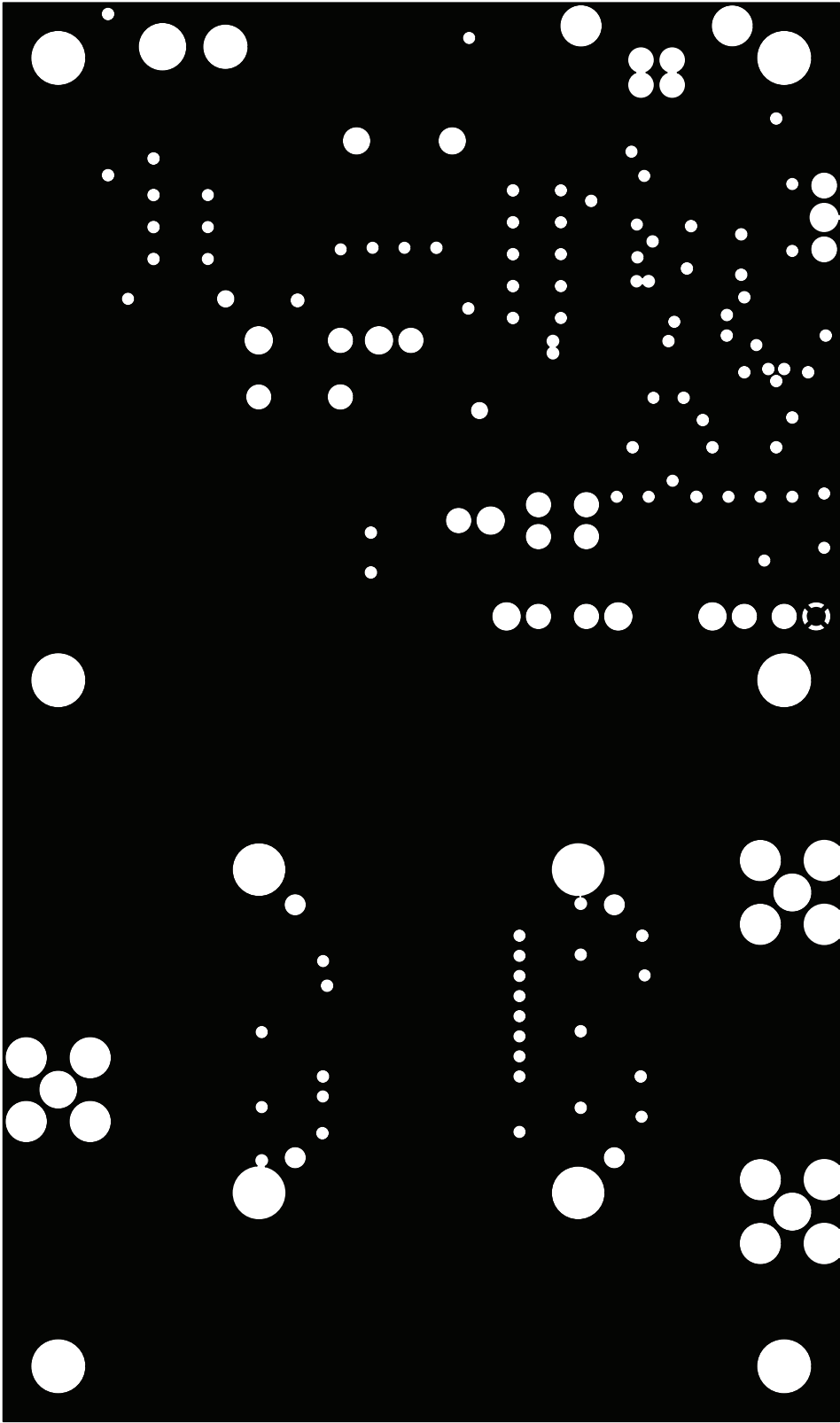

Figure 15. Si57x-EVB-MB 57x_VDD Plane

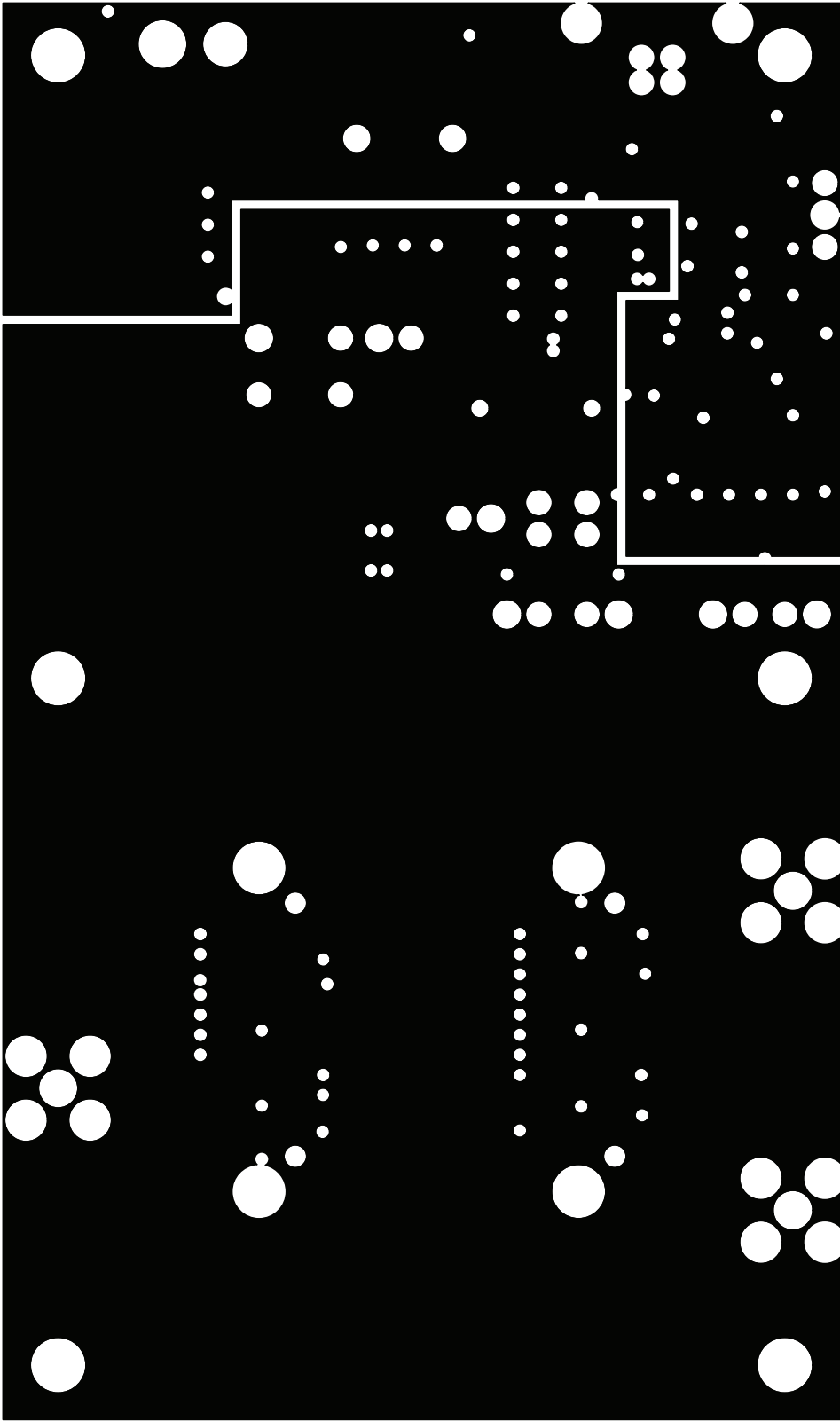

Figure 16. Si57x-EVB-MB 5/3.3 V Plane

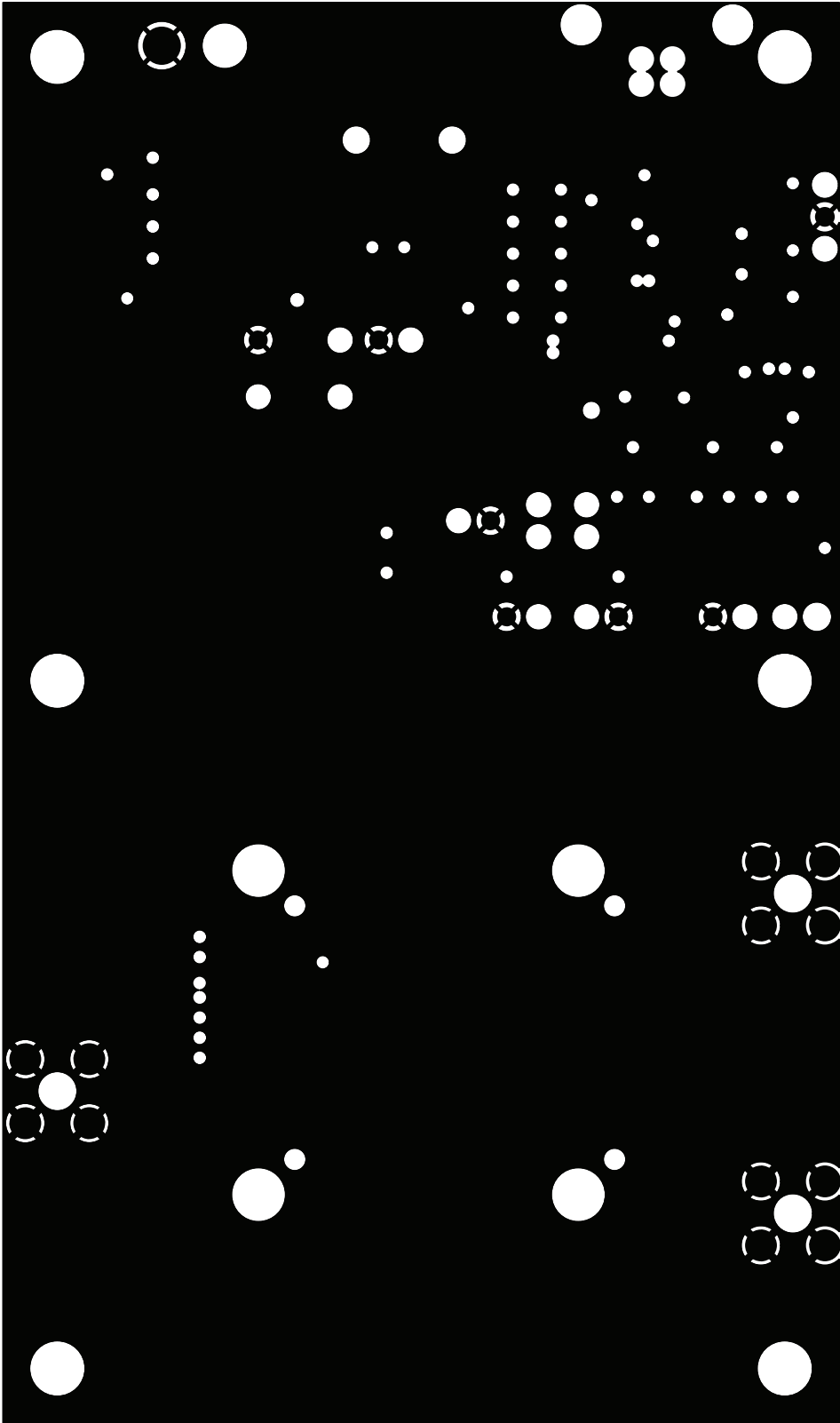

Figure 17. Si57x-EVB-MB GND Plane 2

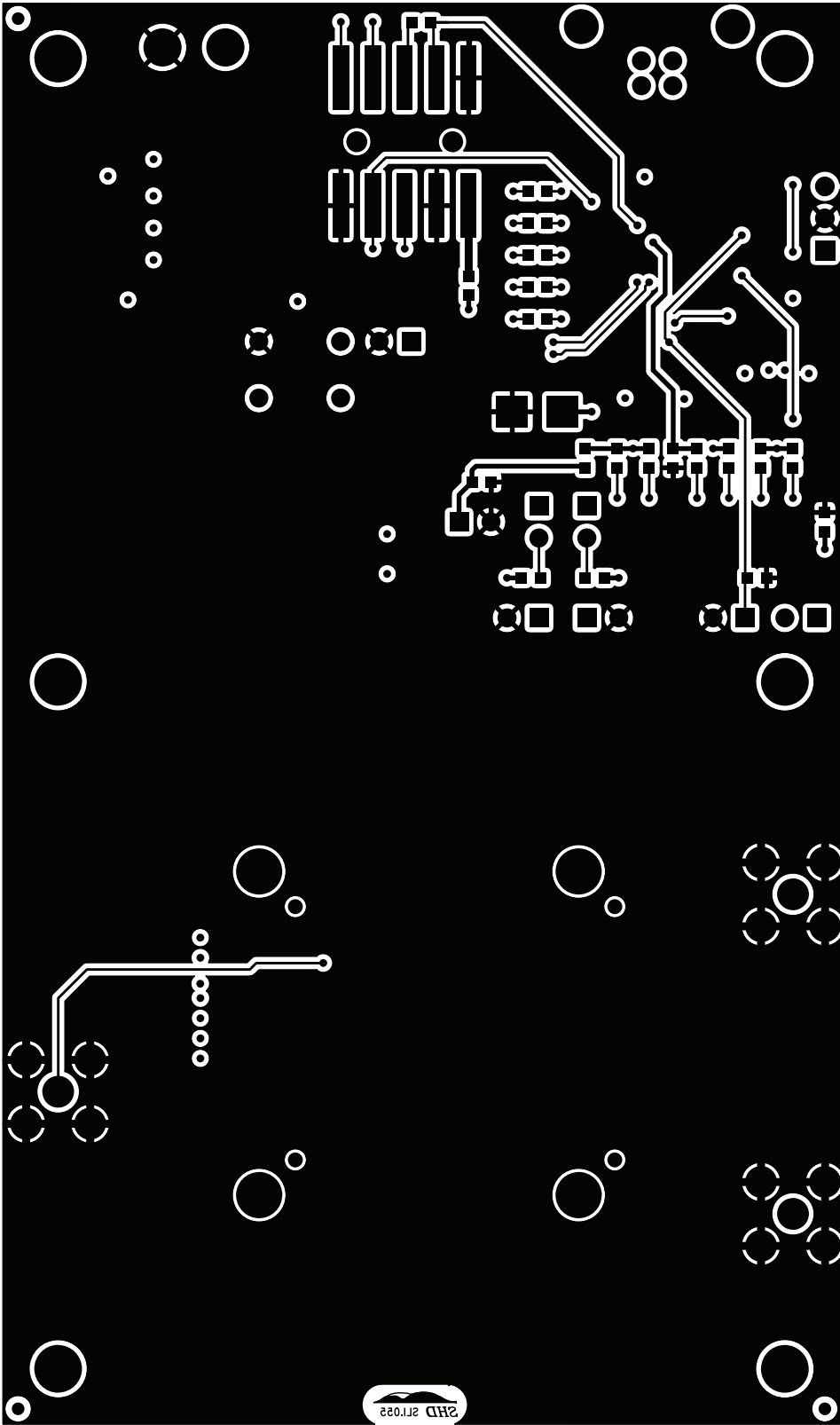

Figure 18. Si57x-EVB-MB Secondary Side

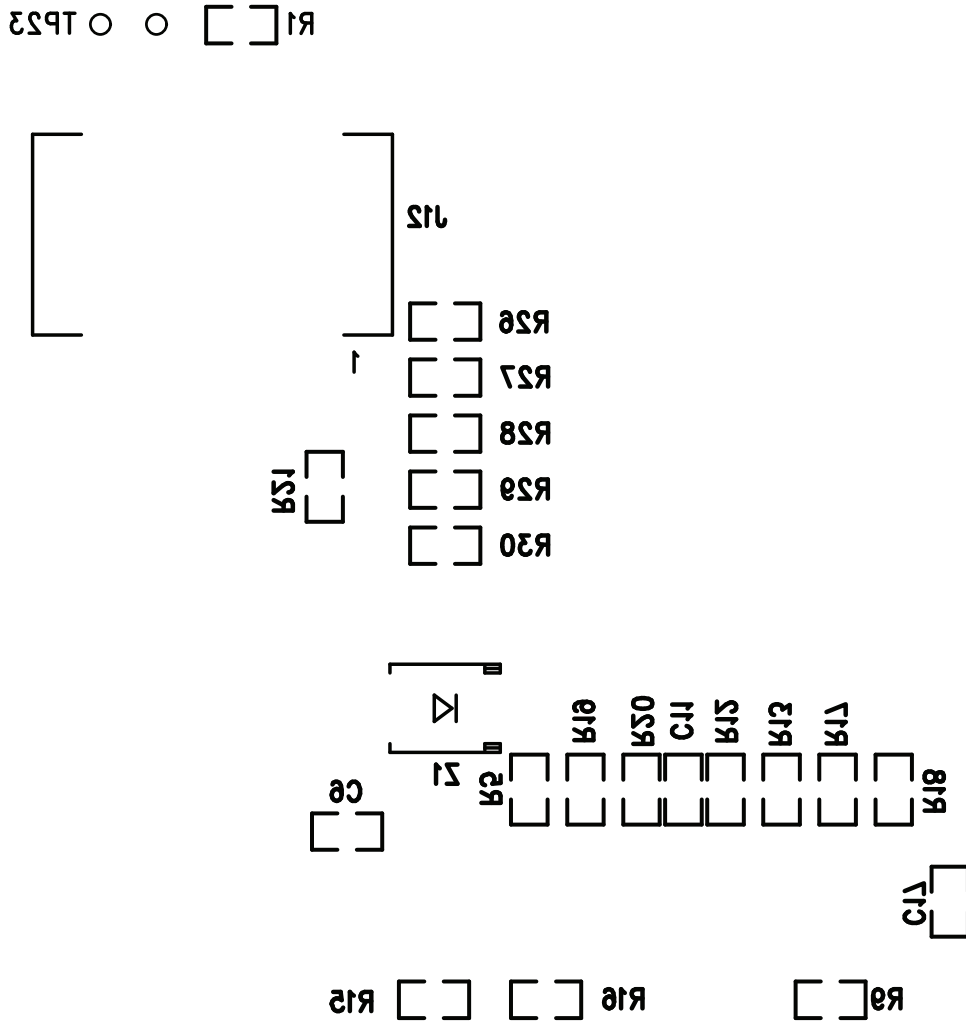

Figure 19. Si57x-EVB-MB Silkscreen Side B

Si57x-EVB

7.2. Si57x-EVB Daughterboard

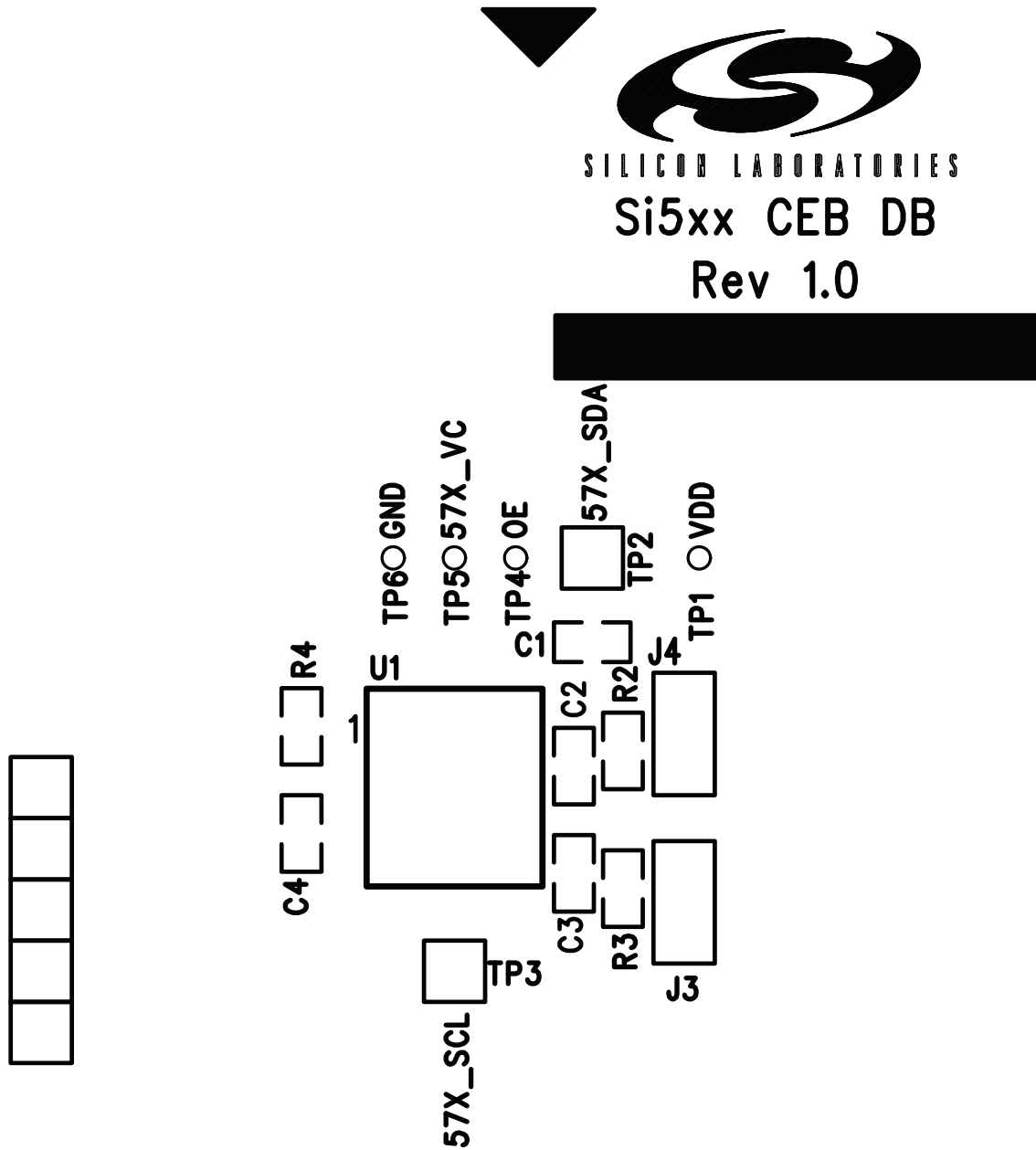

Figure 20. Si57x-EVB-DB Silkscreen Side A

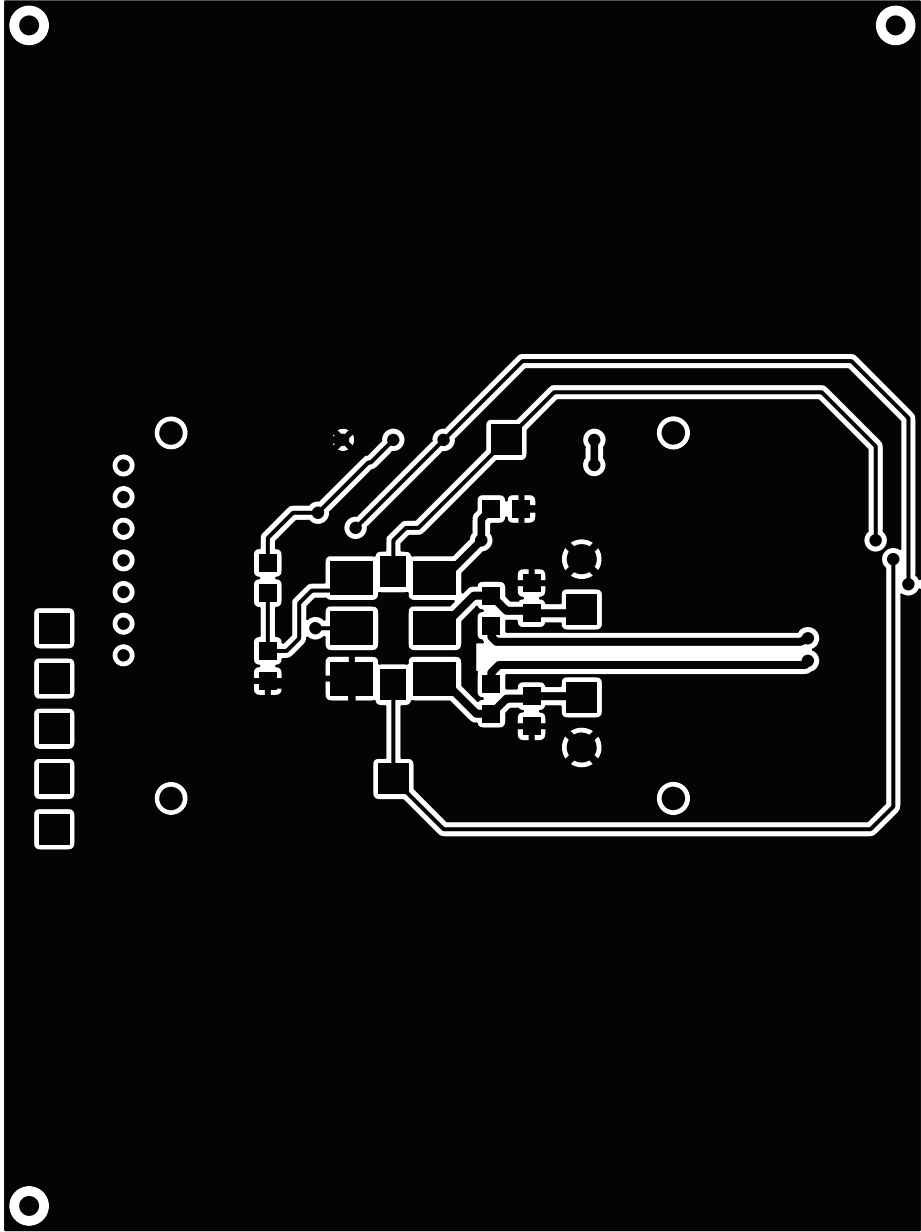

Figure 21. Si57x-EVB-DB Primary Side

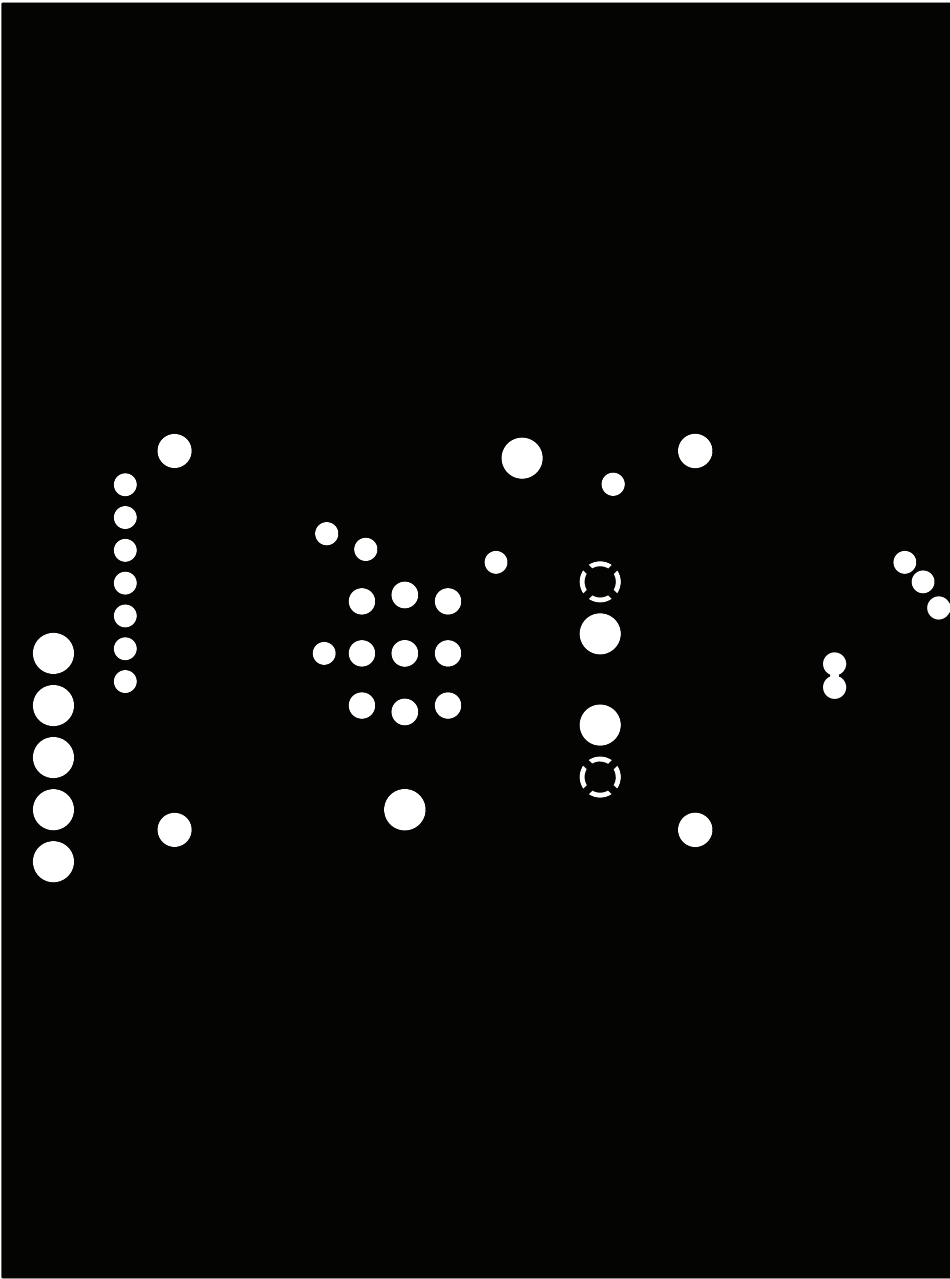

Figure 22. Si57x-EVB-DB GND Plane

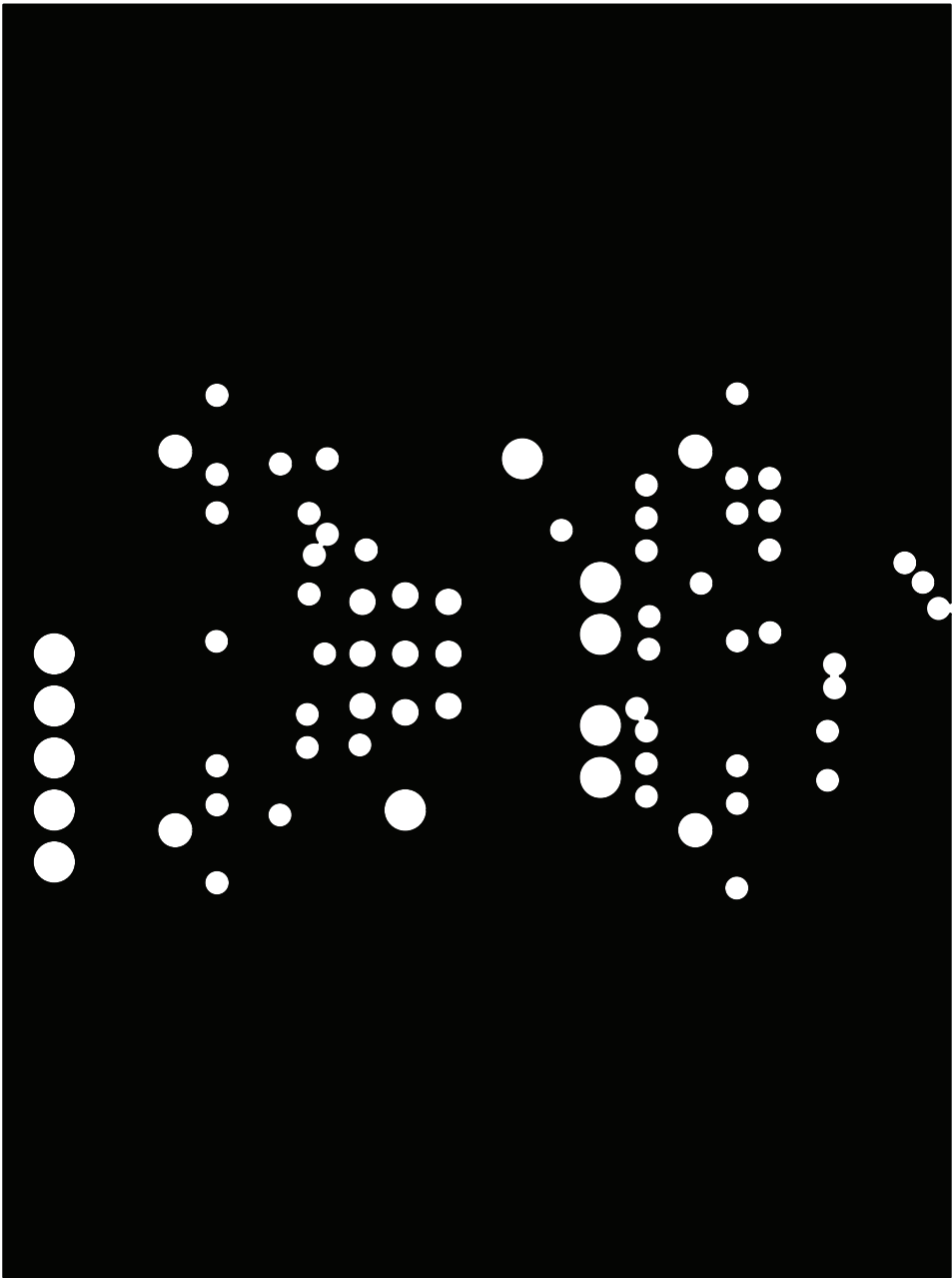

Figure 23. Si57x-EVB-DB 57x_VDD Plane

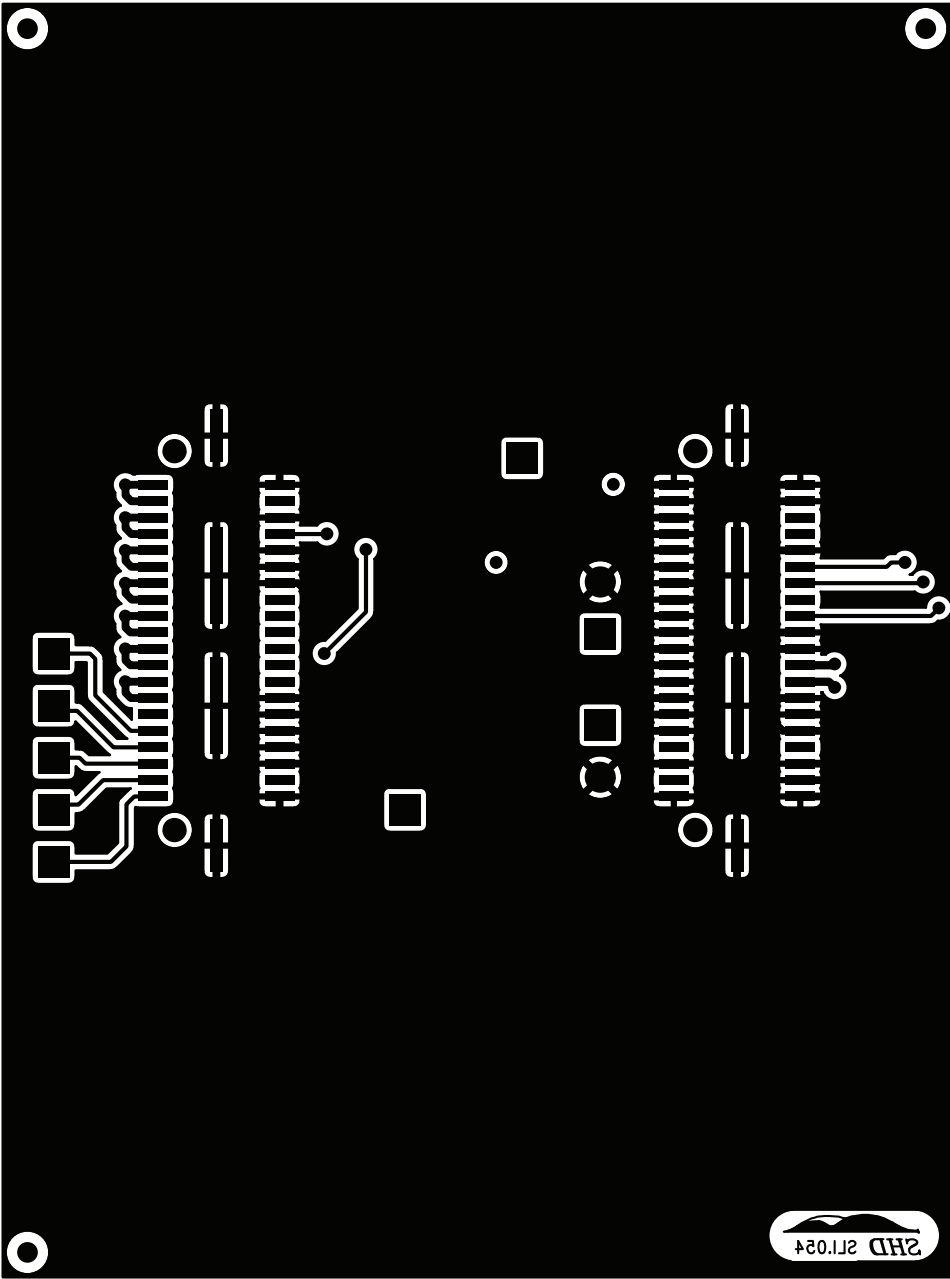

Figure 24. Si57x-EVB-DB Secondary Side

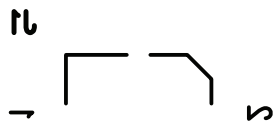
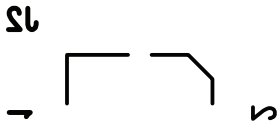

Figure 25. Si57x-EVB-DB Silkscreen Side B

Si57x-EVB

CONTACT INFORMATION

Silicon Laboratories Inc.

400 West Cesar Chavez
Austin, TX 78701
Tel: 1+(512) 416-8500
Fax: 1+(512) 416-9669
Toll Free: 1+(877) 444-3032

Please visit the Silicon Labs Technical Support web page:
<https://www.silabs.com/support/pages/contacttechnicalsupport.aspx>
and register to submit a technical support request.

The information in this document is believed to be accurate in all respects at the time of publication but is subject to change without notice. Silicon Laboratories assumes no responsibility for errors and omissions, and disclaims responsibility for any consequences resulting from the use of information included herein. Additionally, Silicon Laboratories assumes no responsibility for the functioning of undescribed features or parameters. Silicon Laboratories reserves the right to make changes without further notice. Silicon Laboratories makes no warranty, representation or guarantee regarding the suitability of its products for any particular purpose, nor does Silicon Laboratories assume any liability arising out of the application or use of any product or circuit, and specifically disclaims any and all liability, including without limitation consequential or incidental damages. Silicon Laboratories products are not designed, intended, or authorized for use in applications intended to support or sustain life, or for any other application in which the failure of the Silicon Laboratories product could create a situation where personal injury or death may occur. Should Buyer purchase or use Silicon Laboratories products for any such unintended or unauthorized application, Buyer shall indemnify and hold Silicon Laboratories harmless against all claims and damages.

Silicon Laboratories and Silicon Labs are trademarks of Silicon Laboratories Inc.
Other products or brandnames mentioned herein are trademarks or registered trademarks of their respective holders.