

Circular Connectors for Solder Terminations Conforming to JIS-C-5432

JM Series

DDK Ltd.

◆ OUTLINE

JM series is a miniature and lightweight circular connector with high density insert arrangement. This connector conforms to JIS-C-5432, Japanese Industrial Standards. Both of the plastic hoods and the metal hoods are available for your applications. The contacts are for solder terminations. Box mounting receptacle connectors can be also supplied with PCB tails for mounting to a printed circuit board to meet a wide range of electronic devices



◆ FEATURES

1. Miniature and High Density

The contacts available in this series are #20 and #16

2. 5 Keys to Prevent Mismatching

The shell has five keys. Alternate insert positions eliminate the connector mismatching if more than one connector with the same size and arrangement is to be used in a system. The insulator is permanently positioned in the shell so that only a connector with the same degree of rotation can be mated with it.

3. Quick and Easy Termination

The contacts are preloaded in the connector. The solder cups are oriented in one direction to simplify termination

4. UL

UL Approved : File No E72124

◆ SPECIFICATIONS

Note: AWG wire sizes for reference only.

Contact Size	#20 Contact	#16 Contact	
Male Contact Diameter	1.0mm	1.6mm	
Rated Voltage	250V AC(r.m.s.) or 350V DC		
Rated Current	5A / Contact	10A / Contact	
Applicable Cable	Conductor Diameter	1.0mm max.	1.5mm max.
	Nominal Sectional Area	0.5mm ² max.	1.25mm ² max.
	Reference Wire Size	AWG #20 max.	AWG #16 max.
Operating Temperature	- 25°C to + 85°C		
Insulation Resistance	1,000M Ω min. at 500V DC.		
Dielectric Withstanding Voltage	1,000V AC(r.m.s.) at 1 minute.		
Contact Resistance	5m Ω max. at 1A DC		
Vibration	Amplitude : 10-55Hz / 1.5mm		
Shock	Acceleration 50G.		
Durability	500 mating cycles		
Humidity(Stable Condition)	40°C, 90-95%, 96 hours		
Heat Cycle	- 40°C to +100°C : 5 cycles		
Salt Spray	5%, 35°C, 48 hours		

◆ MATERIAL / FINISH



Item	Material / Finish
Insert	PBT Resin (UL94V-0) / Blue
Contact	Copper Alloy / Silver Plating or Gold Plating
Shell	Zinc Alloy / Zinc Plating, Trivalent Chromium Treatment(Black)
Hood	ABS Resin(UL94V-0) / Black Aluminum Alloy / Zinc Plating, Trivalent Chromium Treatment(Black)
Protection Cap	Aluminum Alloy / Anodized Aluminum Processing(Black)

© Specifications and/or dimensions in this catalog are subject to change without notice. © Your checking the latest specifications with our drawings would be highly appreciated.

Conforming
Standard
JIS C 5432

Lock Type
Threaded
Coupling

Safety
Standard
UL



▶ Insert Arrangement List

Shell Size	13		16		21		
Number of Contacts	3	5	7	10	4	7	10
Insert Arrangement							
Insert No.	1303	1305	1607	1610	2104	2107	2110

Shell Size	21		25			
Number of Contacts	16	19	16	24	28	32
Insert Arrangement						
Insert No.	2116	2119	2516	2524	2528	2532

● φ 1.0mm Contact (#20 Contact), ○ φ 1.6mm Contact (#16 Contact)

Note : Front view of pin insert or rear view of socket insert
Normal key position illustrated.

▶ Alternate Insert Positions

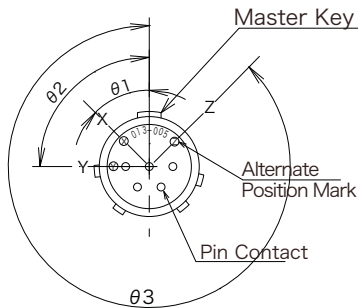

Front View of Pin Insert or Rear View of Socket Insert

Shell Size	Number of Contacts	Change Angle	θ 1	θ 2	θ 3
		Alternate insert Position	X	Y	Z
13	3		30°	60°	180°
	5		45°	90°	315°
16	7		30°	135°	
	10		45°	90°	315°
21	4		30°	135°	
	7		30°	135°	
	10		45°	90°	315°
	16		45°	90°	315°
	19		45°	90°	315°
25	16		45°	90°	315°
	24		45°	90°	315°
	28		45°	90°	315°
	32		45°	90°	315°

▶ Part Numbering System

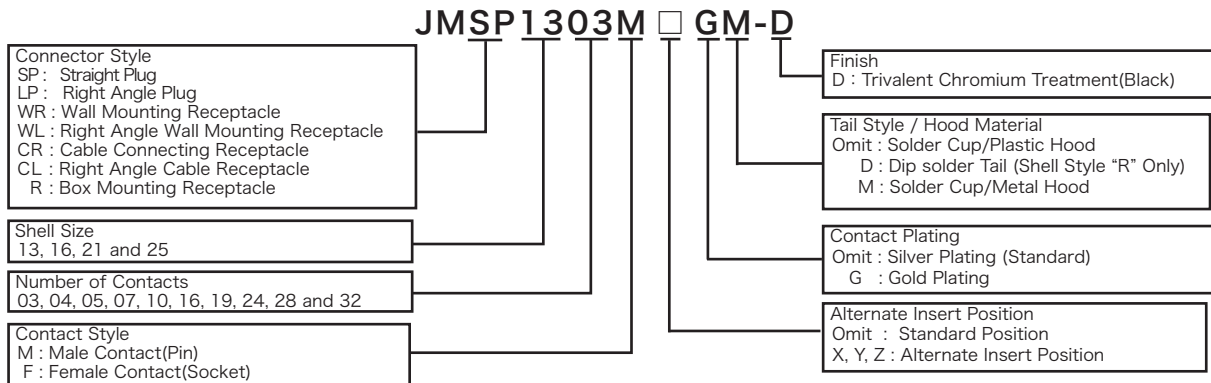

Example part number shown

© Specifications and/or dimensions in this catalog are subject to change without notice. © Your checking the latest specifications with our drawings would be highly appreciated.

▶ Straight Plug

■ Plastic Hood Type

P/N : JMSP1303M □ G-D
 ① ② ③ ④ ⑤ ⑥ ⑦

Example part number shown

① Connector Style	SP : Straight Plug
② Shell Size	13, 16, 21 and 25
③ Number of Contacts	03, 04, 05, 07, 10, 16, 19, 24, 28 and 32
④ Contact Style	M : Male Contact(Pin) F : Female Contact(Socket)
⑤ Alternate Insert Position	Omit : Standard Position X, Y, Z : Alternate Insert Position
⑥ Contact Plating	Omit : Silver Plating (Standard) G : Gold Plating
⑦ Finish	D : Trivalent Chromium Treatment(Black)

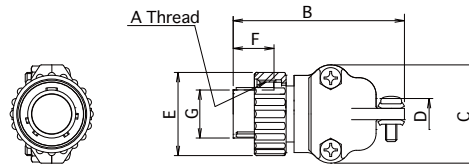

Shell Size	A	B max.	C max.	φ D	E±1	F ⁺⁰ _{-0.8}	φ G ⁺⁰ _{-0.2}
13	M18×1	46.5	26.5	3.0 ~ 8.0	21	11.2	12.7
16	M22×1	48.8	30.5	3.0 ~ 9.0	25	11.2	16.3
21	M26×1	51.8	34.0	8.0 ~ 12.0	29	11.2	20.5
25	M30×1	54.1	37.5	9.6 ~ 15.0	33	11.2	24.7

■ Metal Hood Type

P/N : JMSP1303M □ GM-D
 ① ② ③ ④ ⑤ ⑥ ⑦ ⑧

① Connector Style	SP : Straight Plug
② Shell Size	13, 16, 21 and 25
③ Number of Contacts	03, 04, 05, 07, 10, 16, 19, 24, 28 and 32
④ Contact Style	M : Male Contact(Pin) F : Female Contact(Socket)
⑤ Alternate Insert Position	Omit : Standard Position X, Y, Z : Alternate Insert Position
⑥ Contact Plating	Omit : Silver Plating (Standard) G : Gold Plating
⑦ Hood	M : Metal Hood
⑧ Finish	D : Trivalent Chromium Treatment(Black)

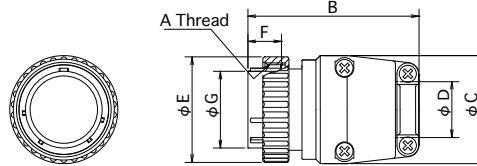

Shell Size	A	B max.	C max.	φ D	E±1	F ⁺⁰ _{-0.8}	φ G ⁺⁰ _{-0.2}
13	M18×1	48.5	24.0	7 ~ 8.7	21	11.2	12.7
16	M22×1	50.5	27.9	8 ~ 10.5	25	11.2	16.3
21	M26×1	52.5	32.1	10 ~ 13.0	29	11.2	20.5
25	M30×1	55.5	35.3	14 ~ 16.0	33	11.2	24.7

▶ Right Angle Plug

■ Plastic Hood Type

P/N : JMLP1303M □ G-D
 ① ② ③ ④ ⑤ ⑥ ⑦

① Connector Style	LP : Right Angle Plug
② Shell Size	13, 16, 21 and 25
③ Number of Contacts	03, 04, 05, 07, 10, 16, 19, 24, 28 and 32
④ Contact Style	M : Male Contact(Pin) F : Female Contact(Socket)
⑤ Alternate Insert Position	Omit : Standard Position X, Y, Z : Alternate Insert Position
⑥ Contact Plating	Omit : Silver Plating (Standard) G : Gold Plating
⑦ Finish	D : Trivalent Chromium Treatment(Black)

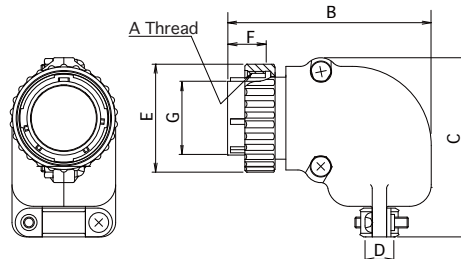

Shell Size	A	B max.	C max.	φ D	E±1	F ⁺⁰ _{-0.8}	φ G ⁺⁰ _{-0.2}
13	M18×1	49.3	41.05	3.0 ~ 8.0	21	11.2	12.7
16	M22×1	55.0	46.00	3.0 ~ 9.0	25	11.2	16.3
21	M26×1	57.5	50.30	8.0 ~ 12.0	29	11.2	20.5
25	M30×1	63.0	54.50	9.6 ~ 15.0	33	11.2	24.7

■ Metal Hood Type

P/N : JMLP1303M □ GM-D
 ① ② ③ ④ ⑤ ⑥ ⑦ ⑧

① Connector Style	LP : Right Angle Plug
② Shell Size	13, 16, 21 and 25
③ Number of Contacts	03, 04, 05, 07, 10, 16, 19, 24, 28 and 32
④ Contact Style	M : Male Contact(Pin) F : Female Contact(Socket)
⑤ Alternate Insert Position	Omit : Standard Position X, Y, Z : Alternate Insert Position
⑥ Contact Plating	Omit : Silver Plating (Standard) G : Gold Plating
⑦ Hood	M : Metal Hood
⑧ Finish	D : Trivalent Chromium Treatment(Black)

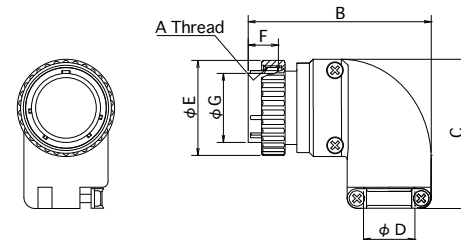

Shell Size	A	B max.	C max.	φ D	φ E±1	F ⁺⁰ _{-0.8}	φ G ⁺⁰ _{-0.2}
13	M18×1	52.5	42.5	7 ~ 8.7	21	11.2	12.7
16	M22×1	57.0	46.5	8 ~ 10.5	25	11.2	16.3
21	M26×1	60.5	50.7	10 ~ 13.0	29	11.2	20.5
25	M30×1	66.0	53.4	14 ~ 16.0	33	11.2	24.7

© Specifications and/or dimensions in this catalog are subject to change without notice. © Your checking the latest specifications with our drawings would be highly appreciated.

▶ Wall Mounting Receptacle

■ Plastic Hood Type

P/N : JMWR 1303M □ G-D
 ① ② ③ ④ ⑤ ⑥ ⑦

① Connector Style	WR : Wall Mounting Receptacle
② Shell Size	13, 16, 21 and 25
③ Number of Contacts	03, 04, 05, 07, 10, 16, 19, 24, 28 and 32
④ Contact Style	M : Male Contact(Pin) F : Female Contact(Socket)
⑤ Alternate Insert Position	Omit : Standard Position X, Y, Z : Alternate Insert Position
⑥ Contact Plating	Omit : Silver Plating (Standard) G : Gold Plating
⑦ Finish	D : Trivalent Chromium Treatment(Black)

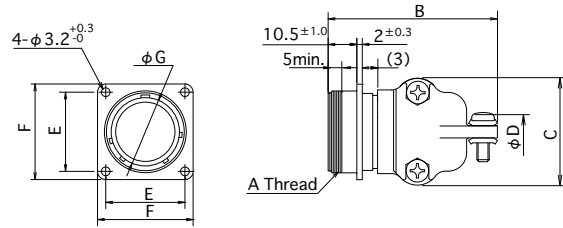

Shell Size	A	B (max.)	C (max.)	φ D	E±0.2	F±0.5	φ G ^{+0.2} ₋₀
13	M18×1	46.5	26.5	3.0 ~ 8.0	20	26	13.0
16	M22×1	48.8	30.5	3.0 ~ 9.0	23	29	16.6
21	M26×1	51.8	34.0	8.0 ~ 12.0	26	32	20.8
25	M30×1	54.1	37.5	9.6 ~ 15.0	29	35	25.0

■ Metal Hood Type

P/N : JMWR 1303M □ GM-D
 ① ② ③ ④ ⑤ ⑥ ⑦ ⑧

① Connector Style	WR : Wall Mounting Receptacle
② Shell Size	13, 16, 21 and 25
③ Number of Contacts	03, 04, 05, 07, 10, 16, 19, 24, 28 and 32
④ Contact Style	M : Male Contact(Pin) F : Female Contact(Socket)
⑤ Alternate Insert Position	Omit : Standard Position X, Y, Z : Alternate Insert Position
⑥ Contact Plating	Omit : Silver Plating (Standard) G : Gold Plating
⑦ Hood	M : Metal Hood
⑧ Finish	D : Trivalent Chromium Treatment(Black)

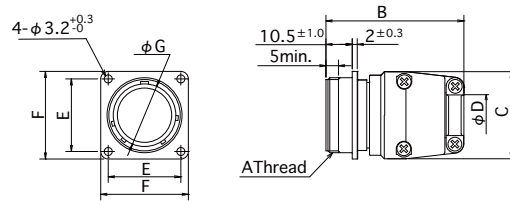

Shell Size	A	B (max.)	C (max.)	φ D	E±0.2	F±0.5	φ G ^{+0.2} ₋₀
13	M18×1	48.5	24.0	7 ~ 8.7	20	26	13.0
16	M22×1	50.5	27.9	8 ~ 10.5	23	29	16.6
21	M26×1	52.5	32.1	10 ~ 13.0	26	32	20.8
25	M30×1	55.5	35.3	14 ~ 16.0	29	35	25.0

▶ Right Angle Wall Mounting Receptacle

■ Metal Hood Type

P/N : JMWL 1303M □ GM-D
 ① ② ③ ④ ⑤ ⑥ ⑦ ⑧

① Connector Style	WL : Right Angle Wall Mounting Receptacle
② Shell Size	13, 16, 21 and 25
③ Number of Contacts	03, 04, 05, 07, 10, 16, 19, 24, 28 and 32
④ Contact Style	M : Male Contact(Pin) F : Female Contact(Socket)
⑤ Alternate Insert Position	Omit : Standard Position X, Y, Z : Alternate Insert Position
⑥ Contact Plating	Omit : Silver Plating (Standard) G : Gold Plating
⑦ Hood	M : Metal Hood
⑧ Finish	D : Trivalent Chromium Treatment(Black)

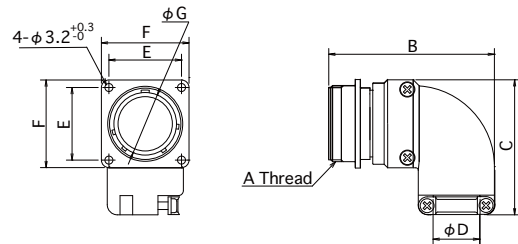

Shell Size	A	B (max.)	C (max.)	φ D	E±0.2	F±0.5	φ G ^{+0.2} ₋₀
13	M18×1	52.5	42.5	7 ~ 8.7	20	26	13.0
16	M22×1	57.0	46.5	8 ~ 10.5	23	29	16.6
21	M26×1	60.5	50.7	10 ~ 13.0	26	32	20.8
25	M30×1	66.0	53.9	14 ~ 16.0	29	35	25.0

▶ Cable Connecting Receptacle

■ Plastic Hood Type

P/N : JMCR1303M □ G-D
 ① ② ③ ④ ⑤ ⑥ ⑦

① Connector Style	CR : Cable Connecting Receptacle
② Shell Size	13, 16, 21 and 25
③ Number of Contacts	03, 04, 05, 07, 10, 16, 19, 24, 28 and 32
④ Contact Style	M : Male Contact(Pin) F : Female Contact(Socket)
⑤ Alternate Insert Position	Omit : Standard Position X, Y, Z : Alternate Insert Position
⑥ Contact Plating	Omit : Silver Plating (Standard) G : Gold Plating
⑦ Finish	D : Trivalent Chromium Treatment(Black)

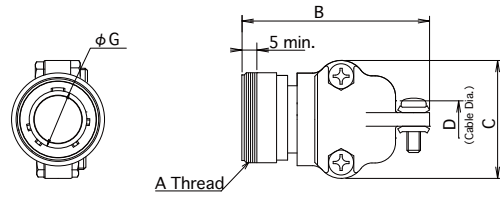

Shell Size	A	B (max.)	C(max.)	φ D	φ G ^{+0.2} _{-0.2}
13	M18×1	46.5	26.5	3.0 ~ 8.0	13.0
16	M22×1	48.8	30.5	3.0 ~ 9.0	16.6
21	M26×1	51.8	34.0	8.0 ~ 12.0	20.8
25	M30×1	54.1	37.5	9.6 ~ 15.0	25.0

■ Metal Hood Type

P/N : JMCR1303M □ GM-D
 ① ② ③ ④ ⑤ ⑥ ⑦ ⑧

① Connector Style	CR : Cable Connecting Receptacle
② Shell Size	13, 16, 21 and 25
③ Number of Contacts	03, 04, 05, 07, 10, 16, 19, 24, 28 and 32
④ Contact Style	M : Male Contact(Pin) F : Female Contact(Socket)
⑤ Alternate Insert Position	Omit : Standard Position X, Y, Z : Alternate Insert Position
⑥ Contact Plating	Omit : Silver Plating (Standard) G : Gold Plating
⑦ Hood	M : Metal Hood
⑧ Finish	D : Trivalent Chromium Treatment(Black)

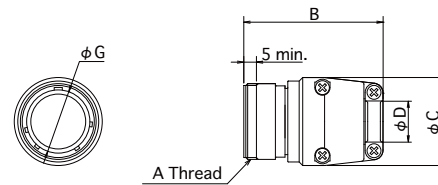

Shell Size	A	B (max.)	C (max.)	φ D	φ G ^{+0.2} _{-0.2}
13	M18×1	48.5	24.0	7 ~ 8.7	13.0
16	M22×1	50.5	27.9	8 ~ 10.5	16.6
21	M26×1	52.5	32.1	10 ~ 13.0	20.8
25	M30×1	55.5	35.3	14 ~ 16.0	25.0

▶ Right Angle Cable Receptacle

■ Metal Hood Type

P/N : JMCL1303M □ GM-D
 ① ② ③ ④ ⑤ ⑥ ⑦ ⑧

① Connector Style	CL : Right Angle Cable Receptacle
② Shell Size	13, 16, 21 and 25
③ Number of Contacts	03, 04, 05, 07, 10, 16, 19, 24, 28 and 32
④ Contact Style	M : Male Contact(Pin) F : Female Contact(Socket)
⑤ Alternate Insert Position	Omit : Standard Position X, Y, Z : Alternate Insert Position
⑥ Contact Plating	Omit : Silver Plating (Standard) G : Gold Plating
⑦ Hood	M : Metal Hood
⑧ Finish	D : Trivalent Chromium Treatment(Black)

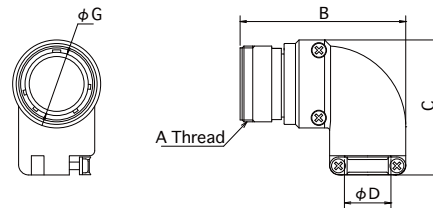

Shell Size	A	B (max.)	C (max.)	φ D	φ G ^{+0.2} _{-0.2}
13	M18×1	52.5	42.5	7 ~ 8.7	13.0
16	M22×1	57.0	46.5	8 ~ 10.5	16.6
21	M26×1	60.5	50.7	10 ~ 13.0	20.8
25	M30×1	66.0	53.9	14 ~ 16.0	25.0

▶ Box Mounting Receptacle

P/N : JMR 1303M □ GD-D
 ① ② ③ ④ ⑤ ⑥ ⑦ ⑧

① Connector Style	R : Box Mounting Receptacle
② Shell Size	13, 16, 21 and 25
③ Number of Contacts	03, 04, 05, 07, 10, 16, 19, 24, 28 and 32
④ Contact Style	M : Male Contact(Pin) F : Female Contact(Socket)
⑤ Alternate Insert Position	Omit : Standard Position X, Y, Z : Alternate Insert Position
⑥ Contact Plating	Omit : Silver Plating (Standard) G : Gold Plating
⑦ Contact Tail	Omit : Solder D : DIP Solder
⑧ Finish	D : Trivalent Chromium Treatment(Black)

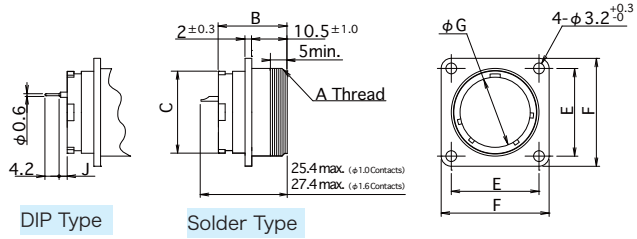

DIP Type

Solder Type

Shell Size	A	B (max.)	C±0.3	E±0.2	F±0.5	φ G ^{+0.2} _{-0.2}	J±0.5
13	M18×1	20.4	16	20	26	13.0	2.5
16	M22×1	20.4	20	23	29	16.6	2.5
21	M26×1	20.4	24	26	32	20.8	2.5
25	M30×1	21.6	28	29	35	25	1.3

▶ JMR DIP Solder PCB Mounting Dimensions

Note : DIP soldering should be made with a mating half connector mated.

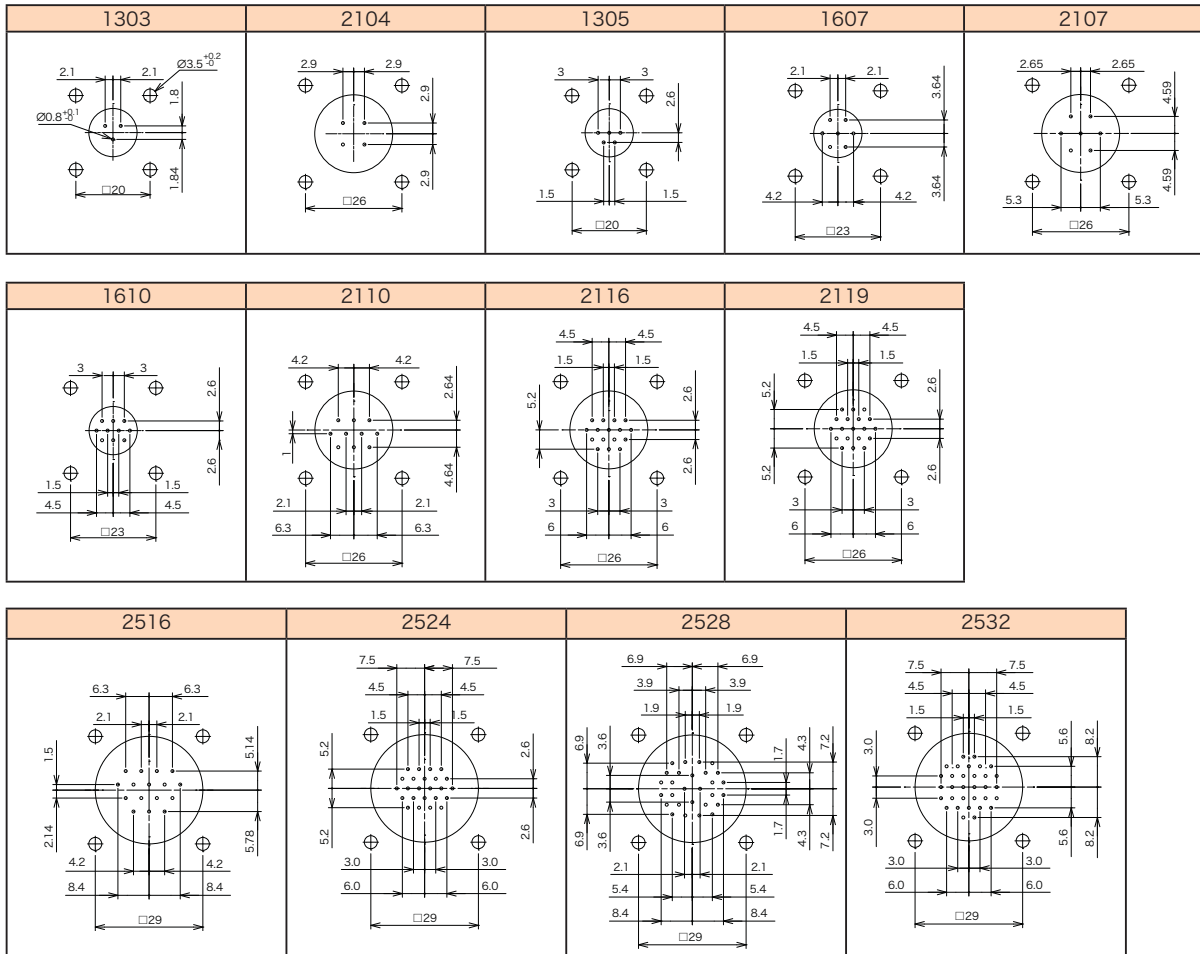

▶ JMR JMWR JMWL Panel Mounting and Cutout Dimensions

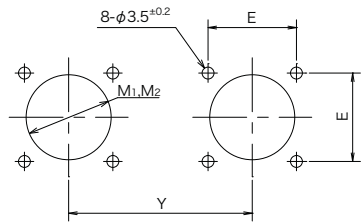

Panel Cutout for Two Connectors of Same Size

Shell Size	Mounting Hole Pitch	Front Mounting Diameter	Rear Mounting Diameter	Serial Mounting Pitch
	E ±0.2	M1 (min.)	M2 (min.)	Y (min.)
13	20	17	19	42
16	23	21	23	46
21	26	25	27	50
25	29	29	31	54

Note: The panel thickness for the rear mounting is 3mm max.

▶ Protection Cap

P/N : JMPC25

① ②

① Cap Style	PC : Plug RC : Receptacle
② Shell Size	13, 16, 21 and 25

Plug Cap

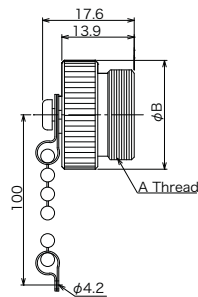

Shell Size	A	B±1
13	M18×1	21
16	M22×1	25
21	M26×1	29
25	M30×1	33

Receptacle Cap

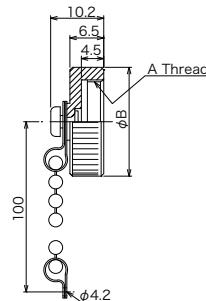

Shell Size	A	B±1
13	M18×1	21
16	M22×1	25
21	M26×1	29
25	M30×1	33