

DIP Switches, Extended Actuator, Auto Insertable, Through Hole and Surface Mount

FEATURES:

- Available in PC or surface mount termination.
- High pressure wiping contact allows aqueous or solvent cleaning without tape seal.
- Auto-insertable
- Tape Seal version available for vacuum pick-n-place
- Unique design can withstand vapor phase reflow or wave soldering conditions.
- Gas tight contacts
- Shipped in the off position

ENVIRONMENTAL SPECIFICATIONS:

Operating Temperature-30°C to + 85°C
 Storage Temperature-45°C to + 100°C
 Solder Heat Resistance.....245°C ± 5°C with switch in "off" position 30 seconds when mounted on a .060" thick PCB per MIL-STD202, Method 210
 Cleaning.....Aqueous solution or solvent

MATERIAL SPECIFICATIONS:

Base and CoverPPS-UL94V-0, (Black)
 Actuator.....PA6T-UL94V-0, (White)
 Fixed Contact/TerminalCopper alloy plate-solder/copper
 Moving ContactCopper alloy plate-gold/nickel

TYPICAL PERFORMANCE CHARACTERISTICS:

Contact Rating0.4 VA @ 20 VDC max.
 Max Rating Switching-100 Milliamp @ 24VDC
 Min Rating Switching-1 Microamp @ 1 Millivolt
 Max Rating Non Switching-1 Amp @ 5VDC
 Initial Contact Resistance50 Milliohms max.
 Insulation Resistance1,000 Megohms min. @ 100 VDC
 Dielectric Strength500 VAC
 Operating ForceLess than 800 grams
 Actuator TravelAD/R Series 1.30mm/.050" piano style 25°
 Life Expectancy1,000 Cycles



ADE

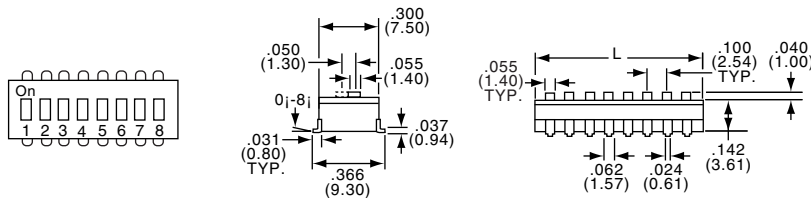

ADE08

Extended Actuator

S Termination Shown

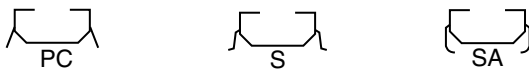

PC Term.		"S" Term.		"SA" Term.		No. of Positions	Actuator Style	Dim. L
Tyco Electronics	Alcoswitch	Tyco Electronics	Alcoswitch	Tyco Electronics	Alcoswitch			
1437586-2	ADE02	1437586-4	ADE02S	1437586-5	ADE02SA	2	Slide	.278(7.06)
1437586-7	ADE03	1437586-8	ADE03S	—	ADE03SA	3	Slide	.378(9.60)
1-1437586-0	ADE04	1-1437586-2	ADE04S	1-1437586-3	ADE04SA	4	Slide	.478(12.14)
1-1437586-5	ADE05	1-1437586-7	ADE05S	—	ADE05SA	5	Slide	.578(14.68)
1-1437586-8	ADE06	2-1437586-0	ADE06S	2-1437586-1	ADE06SA	6	Slide	.678(17.22)
2-1437586-3	ADE07	2-1437586-5	ADE07S	—	ADE07SA	7	Slide	.778(19.76)
2-1437586-6	ADE08	2-1437586-8	ADE08S	2-1437586-9	ADE08SA	8	Slide	.878(22.30)
3-1437586-0	ADE09	—	ADE09S	—	ADE09SA	9	Slide	.978(24.84)
3-1437586-2	ADE10	3-1437586-7	ADE10S	—	ADE10SA	10	Slide	1.078(27.38)
3-1437586-8	ADE12	1571337-1	ADE12S	—	ADE12SA	12	Slide	1.278(32.51)

See Page A9 for PC Pad Layout.

DIP Switches, Flush Acuator, Auto Insertable, Through Hole, and Surface Mount

SEE PAGE A7 FOR PRODUCT SPECIFICATIONS

ADF

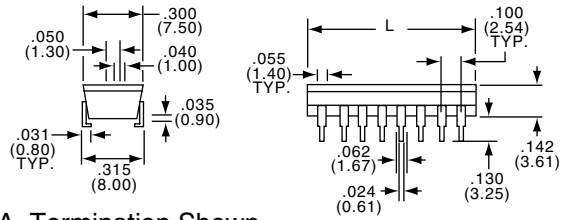
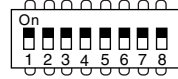

SA Termination Shown

See Page A9 for PC Pad Layout.

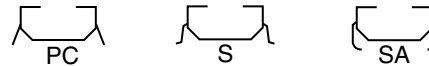

PC Term.		PC Term. w/Tape		No. of Positions	Actuator Style	Dim. L
Tyco Electronics	Alcoswitch	Tyco Electronics	Alcoswitch			
4-1437586-2	ADF02	5-1437586-0	ADF02T	2	Slide	.278(7.06)
5-1437586-1	ADF03	5-1437586-6	ADF03T	3	Slide	.378(9.60)
5-1437586-7	ADF04	6-1437586-4	ADF04T	4	Slide	.478(12.14)
6-1437586-5	ADF05	7-1437586-0	ADF05T	5	Slide	.578(14.68)
7-1437586-1	ADF06	8-1437586-0	ADF06T	6	Slide	.678(17.22)
8-1437586-1	ADF07	8-1437586-5	ADF07T	7	Slide	.778(19.76)
8-1437586-6	ADF08	9-1437586-5	ADF08T	8	Slide	.878(22.30)
9-1437586-6	ADF09	—	ADF09T	9	Slide	.978(24.84)
1437587-1	ADF10	1437587-7	ADF10T	10	Slide	1.078(27.38)
—	ADF12	1571336-1	ADF12T	12	Slide	1.278(32.51)

"S" Term.		"S" Term. w/Tape Seal		Tape & Reel		No. of Positions	Actuator Style	Dim. L
Tyco Electronics	Alcoswitch	Tyco Electronics	Alcoswitch	Tyco Electronics	Alcoswitch			
4-1437586-4	ADF02S	4-1437586-8	ADF02ST	4-1437586-9	ADF02STTR	2	Slide	.278(7.06)
5-1437586-2	ADF03S	5-1437586-4	ADF03ST	5-1437586-5	ADF03STTR	3	Slide	.378(9.60)
5-1437586-9	ADF04S	6-1437586-3	ADF04ST	1437583-6	ADF04STTR	4	Slide	.478(12.14)
6-1437586-6	ADF05S	6-1437586-8	ADF05ST	6-1437586-9	ADF05STTR	5	Slide	.578(14.68)
7-1437586-5	ADF06S	7-1437586-8	ADF06ST	7-1437586-9	ADF06STTR	6	Slide	.678(17.22)
8-1437586-2	ADF07S	8-1437586-3	ADF07ST	8-1437586-4	ADF07STTR	7	Slide	.778(19.76)
8-1437586-8	ADF08S	9-1437586-1	ADF08ST	9-1437586-2	ADF08STTR	8	Slide	.878(22.30)
9-1437586-7	ADF09S	9-1437586-8	ADF09ST	9-1437586-9	ADF09STTR	9	Slide	.978(24.84)
1437587-3	ADF10S	1437587-5	ADF10ST	1437587-6	ADF10STTR	10	Slide	1.078(27.38)
1437587-8	ADF12S	—	ADF12ST	1437587-9	ADF12STTR	12	Slide	1.278(32.51)

"SA" Term.		"SA" Term. w/Tape Seal		No. of Positions	Actuator Style	Dim. L
Tyco Electronics	Alcoswitch	Tyco Electronics	Alcoswitch			
4-1437586-5	ADF02SA	4-1437586-6	ADF02SAT	2	Slide	.278(7.06)
5-1437586-3	ADF03SA	—	ADF03SAT	3	Slide	.378(9.60)
6-1437586-0	ADF04SA	6-1437586-1	ADF04SAT	4	Slide	.478(12.14)
—	ADF05SA	—	ADF05SAT	5	Slide	.578(14.68)
7-1437586-6	ADF06SA	7-1437586-7	ADF06SAT	6	Slide	.678(17.22)
—	ADF07SA	—	ADF07SAT	7	Slide	.778(19.76)
8-1437586-9	ADF08SA	9-1437586-0	ADF08SAT	8	Slide	.878(22.30)
—	ADF09SA	—	ADF09SAT	9	Slide	.978(24.84)
—	ADF10SA	1437587-4	ADF10SAT	10	Slide	1.078(27.38)
—	ADF12SA	—	ADF12SAT	12	Slide	1.278(32.51)

DIP Switches, Piano Acuator, Auto Insertable, Through Hole, and Surface Mount

A
AD Series

ADP



ADP04S

Piano Actuator

"PC" Termination Shown

SEE PAGE A7 FOR PRODUCT SPECIFICATIONS

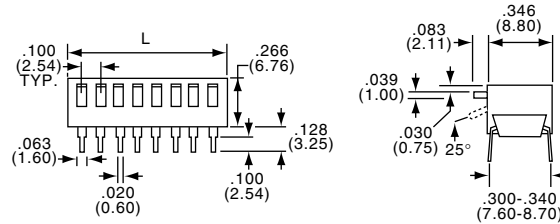

Lever Down "On"		"S" Term Lever Down "On"		"SA" Term. Lever Down "On"		No. of Positions	Actuator Style	Dim. L
Tyco Electronics	Alcoswitch	Tyco Electronics	Alcoswitch	Tyco Electronics	Alcoswitch			
1-1437587-1	ADP02	1-1437587-2	ADP02S	1-1437587-3	ADP02SA	2	Piano	.278(7.06)
1-1437587-5	ADP04	1-1437587-7	ADP04S	1-1437587-8	ADP04SA	4	Piano	.478(12.14)
2-1437587-0	ADP05	2-1437587-1	ADP05S	—	ADP05SA	5	Piano	.578(14.68)
2-1437587-2	ADP06	2-1437587-3	ADP06S	2-1437587-4	ADP06SA	6	Piano	.678(17.22)
2-1437587-5	ADP07	—	ADP07S	—	ADP07SA	7	Piano	.778(19.76)
2-1437587-6	ADP08	2-1437587-8	ADP08S	2-1437587-9	ADP08SA	8	Piano	.878(22.30)
3-1437587-0	ADP09	—	ADP09S	3-1437587-1	ADP09SA	9	Piano	.978(24.84)
3-1437587-3	ADP10	3-1437587-6	ADP10S	—	ADP10SA	10	Piano	1.078(27.38)

Lever Up "On"		"S" Term Lever Up "On"		"SA" Term. Lever Up "On"		No. of Positions	Actuator Style	Dim. L
Tyco Electronics	Alcoswitch	Tyco Electronics	Alcoswitch	Tyco Electronics	Alcoswitch			
4-1437587-7	ADPA02	—	ADPA02S	—	ADPA02SA	2	Piano	.278(7.06)
4-1437587-8	ADPA04	5-1437587-0	ADPA04S	5-1437587-1	ADPA04SA	4	Piano	.478(12.14)
5-1437587-2	ADPA05	5-1437587-3	ADPA05S	—	ADPA05SA	5	Piano	.578(14.68)
5-1437587-4	ADPA06	5-1437587-5	ADPA06S	5-1437587-6	ADPA06SA	6	Piano	.678(17.22)
5-1437587-7	ADPA07	—	ADPA07S	—	ADPA07SA	7	Piano	.778(19.76)
5-1437587-8	ADPA08	6-1437587-0	ADPA08S	—	ADPA08SA	8	Piano	.878(22.30)
—	ADPA09	—	ADPA09S	—	ADPA09SA	9	Piano	.978(24.84)
6-1437587-1	ADPA10	—	ADPA10S	—	ADPA10SA	10	Piano	1.078(27.38)

TERMINATION OPTIONS

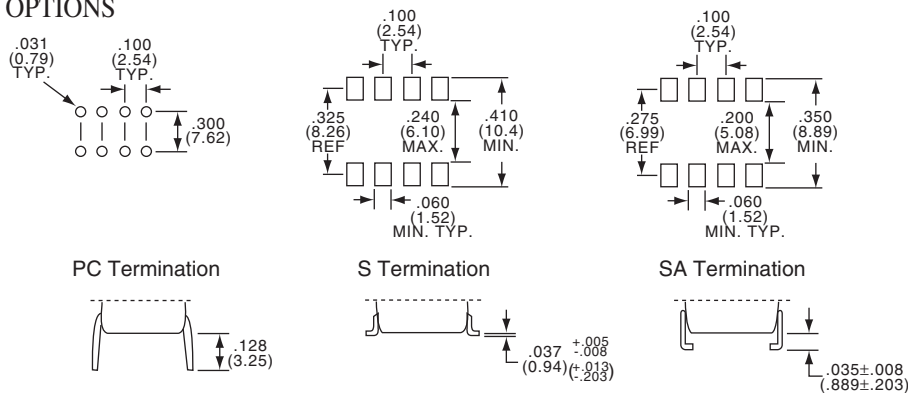

Hybrid DIP Switches, Through Hole and Surface Mount

A
AR Series

AUTO-INSERTABLE* DIP SWITCH WITH INTEGRAL RESISTORS

SEE PAGE A7 FOR PRODUCT SPECIFICATIONS

* Flush actuator versions are auto-insertable

FEATURES:

All the features of the AD SERIES - PLUS

- Thick film pull-up resistors molded into the base of the switch.
- Replaces discrete resistor network plus DIP Switch with one component.
- Available with 3.3K ohms or 10K ohms resistors.
- Ceramic substrate allows wave soldering temperatures of 245°C for up to 30 seconds per MIL-STD 202, Method 210.
- Custom resistor values available.
- Shipped in off position.

Rated Pwr.	Resistance	Tolerance	Max. Voltage
125 mW	3.3K Ohms (red)	±5% at 85°C	24V
125 mW	10K Ohms (green)	±5% at 85°C	24V

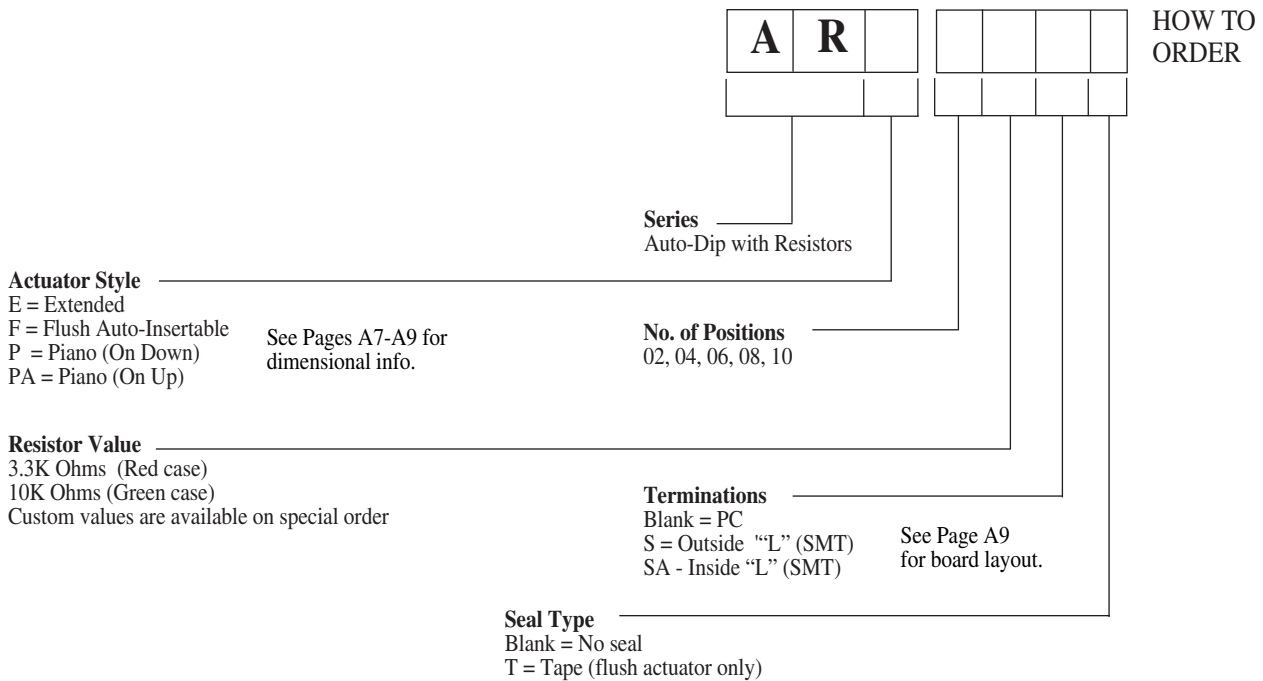
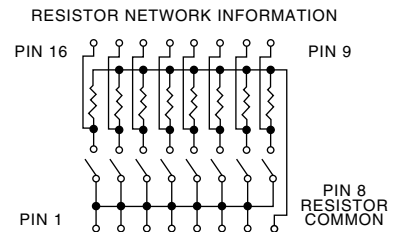

Example: ARF 06 10KST = Auto-Dip
 Flush actuator
 06 positions
 10K ohms resistors
 Outside "L" terminations & tape seal