



AD-BZX84C Series Plastic-Encapsulated Diode

AD-BZX84C series Zener diode

FEATURES

- Planar die construction
- Zener voltages from 2.4V - 43V
- Ultra-small surface mount package with 300mW power dissipation
- AEC-Q101 qualified

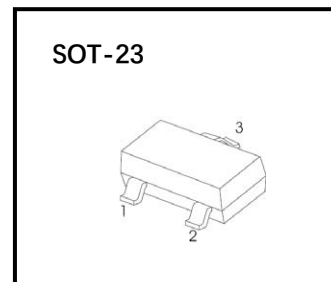

EQUIVALENT CIRCUIT

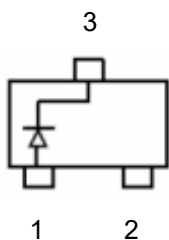

MAXIMUM RATINGS (T_j = 25°C unless otherwise specified)

Parameter	Symbol	Value	Unit
Forward voltage @ I _F = 10mA	V _F ¹⁾	0.9	V
Power dissipation	P _D	300	mW
Thermal resistance from junction to ambient	R _{θJA} ²⁾	417	°C/W
Operating junction and storage temperature range	T _j , T _{stg}	-55 ~ 150	°C

ELECTRICAL CHARACTERISTICS ($T_j = 25^\circ\text{C}$ unless otherwise specified)

Type number	Marking	Zener voltage range ¹⁾				Maximum Zener impedance ³⁾			Maximum reverse current		Temperature coefficient of Zener voltage @ $I_{ZT} = 5\text{mA}$ (mV/°C)	
		$V_Z @ I_{ZT}$ (V)			I_{ZT} (mA)	Z_{ZT} @ I_{ZT} (Ω)	Z_{ZK} @ I_{ZK} (Ω)	I_{ZK} (mA)	I_R (μA)	V_R (V)	Min	Max
		Min	Norm	Max								
AD-BZX84C2V4	$\bar{Z}11$	2.2	2.4	2.6	5	100	600	1.0	50	1.0	-3.5	0
AD-BZX84C2V7	$\bar{Z}12$	2.5	2.7	2.9	5	100	600	1.0	20	1.0	-3.5	0
AD-BZX84C3V0	$\bar{Z}13$	2.8	3.0	3.2	5	95	600	1.0	10	1.0	-3.5	0
AD-BZX84C3V3	$\bar{Z}14$	3.1	3.3	3.5	5	95	600	1.0	5	1.0	-3.5	0
AD-BZX84C3V6	$\bar{Z}15$	3.4	3.6	3.8	5	90	600	1.0	5	1.0	-3.5	0
AD-BZX84C3V9	$\bar{Z}16$	3.7	3.9	4.1	5	90	600	1.0	3	1.0	-3.5	0
AD-BZX84C4V3	$\bar{Z}17$	4.0	4.3	4.6	5	90	600	1.0	3	1.0	-3.5	0
AD-BZX84C4V7	$\bar{Z}1$	4.4	4.7	5.0	5	80	500	1.0	3	2.0	-3.5	0.2
AD-BZX84C5V1	$\bar{Z}2$	4.8	5.1	5.4	5	60	480	1.0	2	2.0	-2.7	1.2
AD-BZX84C5V6	$\bar{Z}3$	5.2	5.6	6.0	5	40	400	1.0	1	2.0	-2.0	2.5
AD-BZX84C6V2	$\bar{Z}4$	5.8	6.2	6.6	5	10	150	1.0	3	4.0	0.4	3.7
AD-BZX84C6V8	$\bar{Z}5$	6.4	6.8	7.2	5	15	80	1.0	2	4.0	1.2	4.5
AD-BZX84C7V5	$\bar{Z}6$	7.0	7.5	7.9	5	15	80	1.0	1	5.0	2.5	5.3
AD-BZX84C8V2	$\bar{Z}7$	7.7	8.2	8.7	5	15	80	1.0	0.7	5.0	3.2	6.2
AD-BZX84C9V1	$\bar{Z}8$	8.5	9.1	9.6	5	15	100	1.0	0.5	6.0	3.8	7.0
AD-BZX84C10	$\bar{Z}9$	9.4	10	10.6	5	20	150	1.0	0.2	7.0	4.5	8.0
AD-BZX84C11	$\bar{Y}1\bullet$	10.4	11	11.6	5	20	150	1.0	0.1	8.0	5.4	9.0
AD-BZX84C12	$\bar{Y}2\bullet$	11.4	12	12.7	5	25	150	1.0	0.1	8.0	6.0	10.0
AD-BZX84C13	$\bar{Y}3$	12.4	13	14.1	5	30	170	1.0	0.1	8.0	7.0	11.0
AD-BZX84C15	$\bar{Y}4$	13.8	15	15.6	5	30	200	1.0	0.1	10.5	9.2	13.0
AD-BZX84C16	$\bar{Y}5$	15.3	16	17.1	5	40	200	1.0	0.1	11.2	10.4	14.0
AD-BZX84C18	$\bar{Y}6\bullet$	16.8	18	19.1	5	45	225	1.0	0.1	12.6	12.4	16.0
AD-BZX84C20	$\bar{Y}7$	18.8	20	21.2	5	55	225	1.0	0.1	14.0	14.4	18.0
AD-BZX84C22	$\bar{Y}8$	20.8	22	23.3	5	55	250	1.0	0.1	15.4	16.4	20.0
AD-BZX84C24	$\bar{Y}9$	22.8	24	25.6	5	70	250	1.0	0.1	16.8	18.4	22.0
AD-BZX84C27	$\bar{Y}10$	25.1	27	28.9	2	80	300	0.5	0.1	18.9	21.4	25.3
AD-BZX84C30	$\bar{Y}11\bullet$	28.0	30	32.0	2	80	300	0.5	0.1	21.0	24.4	29.4
AD-BZX84C33	$\bar{Y}12$	31.0	33	35.0	2	80	325	0.5	0.1	23.1	27.4	33.4
AD-BZX84C36	$\bar{Y}13$	34.0	36	38.0	2	90	350	0.5	0.1	25.2	30.4	37.4
AD-BZX84C39	$\bar{Y}14$	37.0	39	41.0	2	130	350	0.5	0.1	27.3	33.4	41.2

1) Tested with pulses, period = 5ms, pulse width = 300 μs .2) Measured with the device mounted on 1 inch² FR-4 board with 1oz. single-side copper, in a still air environment with $T_a = 25^\circ\text{C}$.3) $f = 1\text{kHz}$.

TYPICAL CHARACTERISTICS

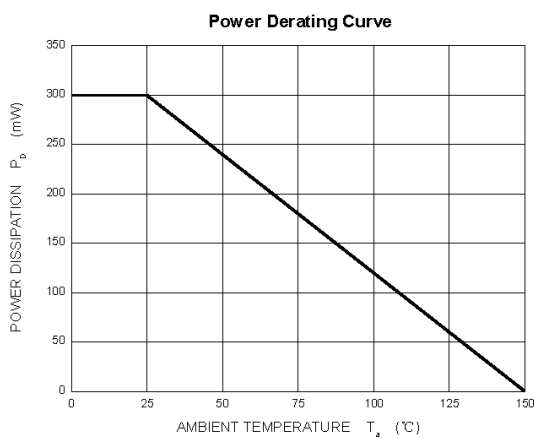
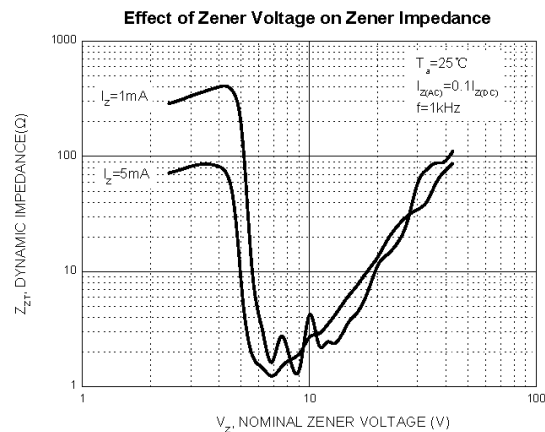
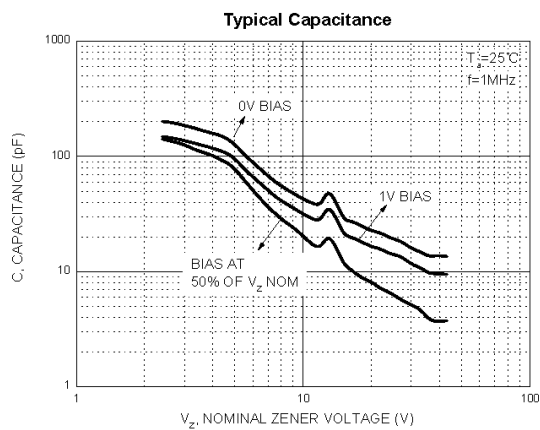
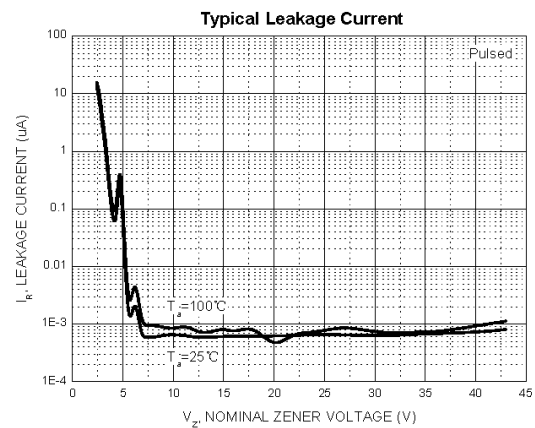
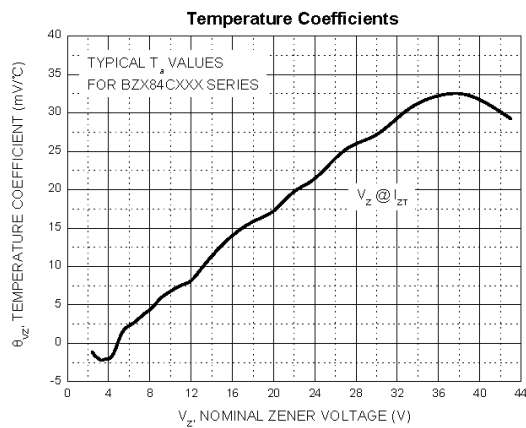
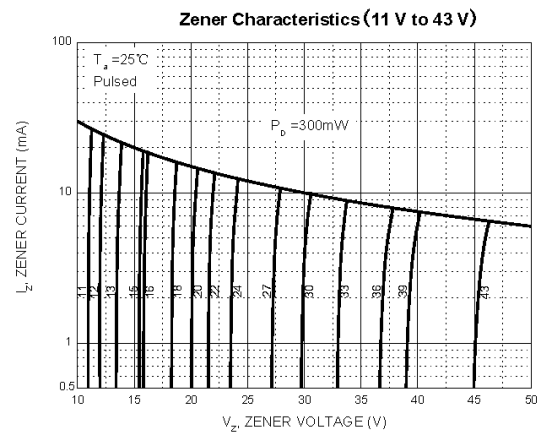
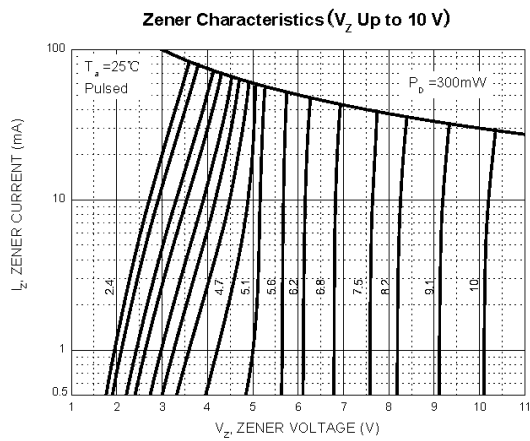

SOT-23 PACKAGE OUTLINE DIMENSIONS

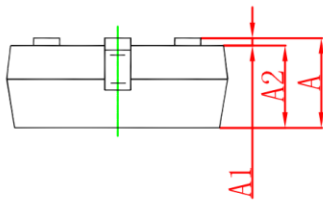
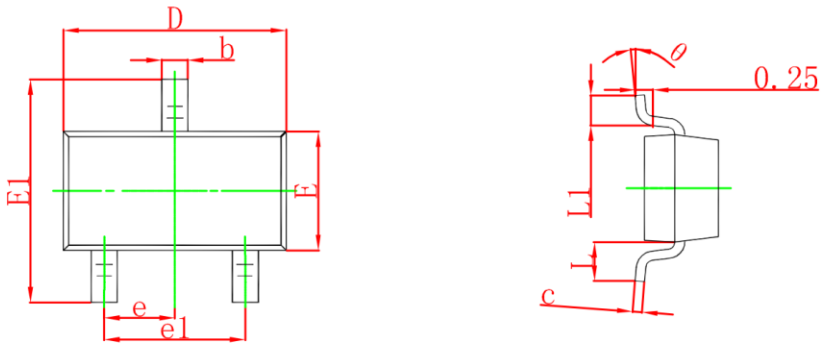

Symbol	Dimensions in Millimeters		Dimensions in Inches	
	Min	Max	Min	Max
A	0.900	1.150	0.035	0.045
A1	0.000	0.100	0.000	0.004
A2	0.900	1.050	0.035	0.041
b	0.300	0.500	0.012	0.020
c	0.080	0.150	0.003	0.006
D	2.800	3.000	0.110	0.118
E	1.200	1.400	0.047	0.055
E1	2.250	2.550	0.089	0.100
e	0.950 TYP		0.037 TYP	
e1	1.800	2.000	0.071	0.079
L	0.550 REF		0.022 REF	
L1	0.300	0.500	0.012	0.020
theta	0°	8°	0°	8°

SOT-23 SUGGESTED PAD LAYOUT

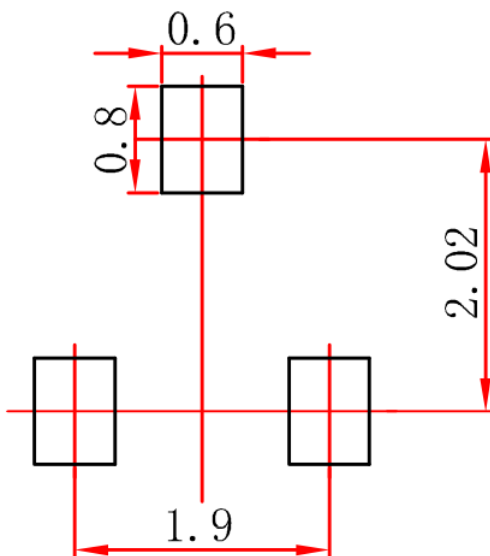

Note:

1. Controlling dimension in millimeters.
2. General tolerance: $\pm 0.05\text{mm}$.
3. The pad layout is for reference purpose only.

SOT-23 TAPE AND REEL

SOT-23 Embossed Carrier Tape

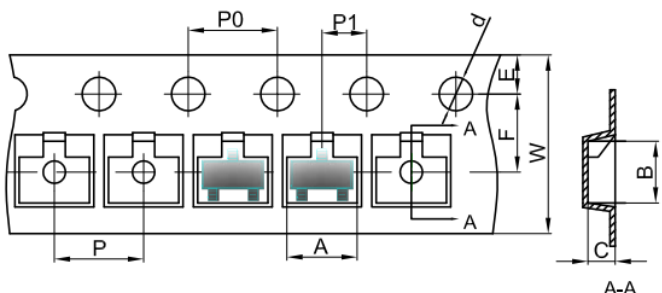

Packaging Description:
 SOT-23 parts are shipped in tape. The carrier tape is made from a dissipative (carbon filled) polycarbonate resin. The cover tape is a multilayer film (Heat Activated Adhesive in nature) primarily composed of polyester film, adhesive layer, sealant, and anti-static sprayed agent. These reeled parts in standard option are shipped with 3,000 units per 7" or 17.8cm diameter reel. The reels are clear in color and is made of polystyrene plastic (anti-static coated).

Dimensions are In millimeter										
Pkg type	A	B	C	d	E	F	P0	P	P1	W
SOT-23	3.15	2.77	1.22	Ø1.50	1.75	3.50	4.00	4.00	2.00	8.00

SOT-23 Tape Leader and Trailer

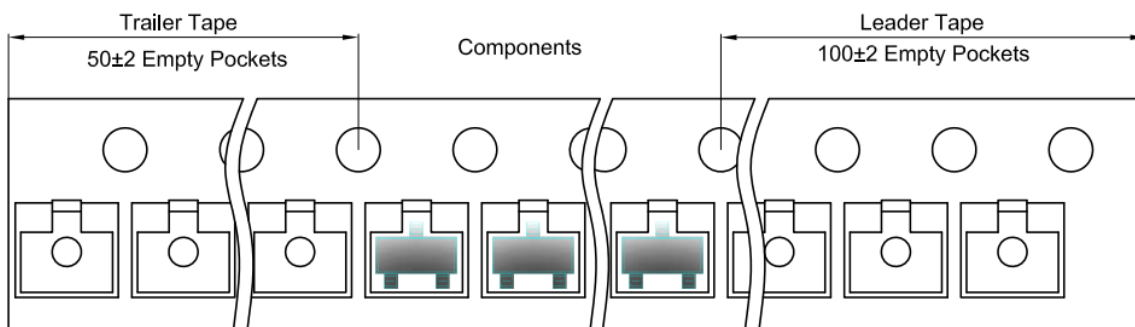

SOT-23 Reel

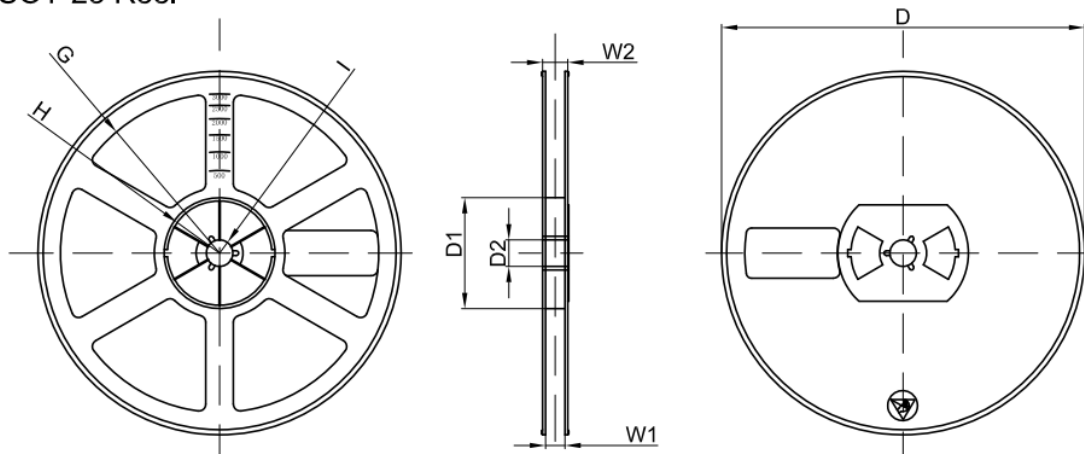

Dimensions are in millimeter								
Reel Option	D	D1	D2	G	H	I	W1	W2
7" Dia	Ø178.00	54.40	13.00	R78.00	R25.60	R6.50	9.50	12.30

REEL	Reel Size	Box	Box Size(mm)	Carton	Carton Size(mm)	G.W.(kg)
3000 pcs	7 inch	45,000 pcs	203×203×195	180,000 pcs	438×438×220	

PUBLISHED BY

JIANGSU CHANGJING ELECTRONICS TECHNOLOGY CO., LTD.

13th Floor, C Block, Tengfei Building, Yan Chuang Yuan, Nanjing Jiangbei New Area, China

LEGAL DISCLAIMER

The information given in this document shall in no event be regarded as a guarantee of conditions or characteristics. With respect to any examples, hints or typical values stated herein and/or any information regarding the application of the device, JSCJ hereby disclaims any and all warranties and liabilities of any kind, including without limitation, warranties of non-infringement of intellectual property rights of any third party.

In addition, any information given in this document is subject to customer's compliance with its obligations stated in this document and any applicable legal requirements, norms and standards concerning customer's products and any use of the product of JSCJ in customer's applications.

The data contained in this document is exclusively intended for technically trained staff. It is the responsibility of customer's technical departments to evaluate the suitability of the product for the intended application and the completeness of the product information given in this document with respect to such application.

INFORMATION

For further information on technology, delivery terms and conditions as well as prices, please contact your nearest JSCJ office (www.jscj-elec.com).

WARNINGS

Due to technical requirements, products may contain dangerous substances. For information on the types in question, please contact your nearest JSCJ office.

Except as otherwise explicitly approved by JSCJ in a written document signed by authorized representatives of JSCJ, JSCJ's products may not be used in any applications where a failure of the product or any consequences of the use thereof can reasonably be expected to result in personal injury.