

Power TOPLED® Enhanced optical Power LED (ATON®)

LB E67C, LV E67C, LT E67C



Vorläufige Daten / Preliminary Data

Besondere Merkmale

- **Gehäusetypp:** weißes P-LCC-4 Gehäuse
- **Besonderheit des Bauteils:** mehr Licht durch erhöhten optischen Wirkungsgrad; höhere Umgebungstemperatur bei gleichem Strom im Vergleich zur TOPLED® möglich
- **Wellenlänge:** 469 nm (blau), 503 nm (verde), 525 nm (true green)
- **Abstrahlwinkel:** Lambertischer Strahler (120°)
- **Technologie:** InGaN
- **optischer Wirkungsgrad:** 3 lm/W (blau), 10 lm/W (verde), 13 lm/W (true green)
- **Gruppierungsparameter:** Lichtstärke, Wellenlänge
- **Verarbeitungsmethode:** für alle SMT-Bestücktechniken geeignet
- **Lötmethode:** IR Reflow Löten und Wellenlöten (TTW)
- **Vorbehandlung:** nach JEDEC Level 2
- **Gurtung:** 8 mm Gurt mit 2000/Rolle, ø180 mm oder 8000/Rolle, ø330 mm
- **ESD-Festigkeit:** ESD-sicher bis 2 kV nach EOS/ESD-5.1-1993

Anwendungen

- Ampelanwendung (verde)
- Hinterleuchtung (LCD, Schalter, Tasten, Displays, Werbebeleuchtung, Allgemeinbeleuchtung)
- Innenbeleuchtung im Automobilbereich (z.B. Instrumentenbeleuchtung, u. ä.)
- Ersatz von Kleinst-Glühlampen
- Markierungsbeleuchtung (z.B. Stufen, Fluchtwege, u.ä.)
- Signal- und Symbolleuchten
- Scanner

Features

- **package:** white P-LCC-4 package
- **feature of the device:** more light due to higher optical efficiency; higher ambient temperature at the same current possible compared to TOPLED®
- **wavelength:** 469 nm (blue), 503 nm (verde), 525 nm (true green)
- **viewing angle:** Lambertian Emitter (120°)
- **technology:** InGaN
- **optical efficiency:** 3 lm/W (blue), 10 lm/W (verde), 13 lm/W (true green)
- **grouping parameter:** luminous intensity, wavelength
- **assembly methods:** suitable for all SMT assembly methods
- **soldering methods:** IR reflow soldering and TTW soldering
- **preconditioning:** acc. to JEDEC Level 2
- **taping:** 8 mm tape with 2000/reel, ø180 mm or 8000/reel, ø330 mm
- **ESD-withstand voltage:** up to 2 kV acc. to EOS/ESD-5.1-1993

Applications

- traffic lights (verde)
- backlighting (LCD, switches, keys, displays, illuminated advertising, general lighting)
- interior automotive lighting (e.g. dashboard backlighting, etc.)
- substitution of micro incandescent lamps
- marker lights (e.g. steps, exit ways, etc.)
- signal and symbol luminaire
- scanners

Typ	Emissions- farbe	Farbe der Lichtaustritts- fläche	Lichtstärke	Lichtstrom	Bestellnummer
Type	Color of Emission	Color of the Light Emitting Area	Luminous Intensity $I_F = 30 \text{ mA}$ $I_V \text{ (mcd)}$	Luminous Flux $I_F = 30 \text{ mA}$ $\Phi_V \text{ (mlm)}$	Ordering Code
LB E67C-P2Q2-35	blue	colorless clear	56 ... 112	250 (typ.)	Q62703-Q6235
LB E67C-Q2S1-35			90 ... 224	470 (typ.)	Q62703-Q6236
LV E67C-S2T2-35	verde	colorless clear	224 ... 450	1000 (typ.)	Q62703-Q6286
LV E67C-T2V1-35			355 ... 900	1900 (typ.)	Q65110-A0185
LT E67C-S2T2-35	true green	colorless clear	224 ... 450	1000 (typ.)	Q65110-A0273
LT E67C-T2V1-35			355 ... 900	1900 (typ.)	Q65110-A0274

Anm.: -35 gesamter Farbbereich, Lieferung in Einzelgruppen (siehe **Seite 5**)

*Die Standardlieferform von Serientypen beinhaltet eine untere bzw. eine obere Familiengruppe, die aus nur 3 bzw. 4 Halbgruppen besteht. Einzelne Halbgruppen sind nicht erhältlich.
In einer Verpackungseinheit / Gurt ist immer nur eine Halbgruppe enthalten.*

Note: -35 Total color tolerance range, delivery in single groups (please see **page 5**)

*The standard shipping format for serial types includes a lower or upper family group of 3 or 4 individual groups. Individual half groups are not available.
No packing unit / tape ever contains more than one luminous intensity half group.*

Grenzwerte
Maximum Ratings

Bezeichnung Parameter	Symbol Symbol	Werte Values		Einheit Unit
		LB	LV, LT	
Betriebstemperatur Operating temperature range	T_{op}	- 40 ... + 100		°C
Lagertemperatur Storage temperature range	T_{stg}	- 40 ... + 100		°C
Sperrschichttemperatur Junction temperature	T_j	+ 110	+ 125	°C
Durchlassstrom Forward current	I_F	30		mA
Stoßstrom Surge current $t \leq 10 \mu s, D = 0.005$	I_{FM}	200	250	mA
Sperrspannung Reverse voltage	V_R	5		V
Leistungsaufnahme Power consumption	P_{tot}	140		mW
Wärmewiderstand Thermal resistance Sperrschicht/Umgebung Junction/ambient	$R_{th JA}$	350		K/W
Sperrschicht/Löt看pad Junction/solder point Montage auf PC-Board FR 4 (Padgröße $\geq 16 \text{ mm}^2$) mounted on PC board FR 4 (pad size $\geq 16 \text{ mm}^2$)	$R_{th JS}$	180		K/W

Kennwerte ($T_A = 25\text{ °C}$)
Characteristics

Bezeichnung Parameter	Symbol Symbol	Werte Values			Einheit Unit
		LB	LV	LT	
Wellenlänge des emittierten Lichtes Wavelength at peak emission $I_F = 30\text{ mA}$	(typ.) λ_{peak}	464	501	520	nm
Dominantwellenlänge ¹⁾ Dominant wavelength $I_F = 30\text{ mA}$	(typ.) λ_{dom}	469 ± 6	503 ± 6	525 ± 9	nm
Spektrale Bandbreite bei 50 % $I_{\text{rel max}}$ Spectral bandwidth at 50 % $I_{\text{rel max}}$ $I_F = 30\text{ mA}$	(typ.) $\Delta\lambda$	25	30	33	nm
Abstrahlwinkel bei 50 % I_V (Vollwinkel) Viewing angle at 50 % I_V	(typ.) 2ϕ	120	120	120	Grad deg.
Durchlassspannung ²⁾ Forward voltage $I_F = 30\text{ mA}$	(typ.) V_F (max.) V_F	4.1 4.6	3.8 4.6	3.8 4.6	V V
Sperrstrom Reverse current $V_R = 5\text{ V}$	(typ.) I_R (max.) I_R	0.01 10	0.01 10	0.01 10	μA μA
Temperaturkoeffizient von λ_{peak} Temperature coefficient of λ_{peak} $I_F = 30\text{ mA}; -10\text{ °C} \leq T \leq 100\text{ °C}$	(typ.) $TC_{\lambda_{\text{peak}}}$	0.05	0.03	0.04	nm/K
Temperaturkoeffizient von λ_{dom} Temperature coefficient of λ_{dom} $I_F = 30\text{ mA}; -10\text{ °C} \leq T \leq 100\text{ °C}$	(typ.) $TC_{\lambda_{\text{dom}}}$	0.04	0.02	0.03	nm/K
Temperaturkoeffizient von V_F Temperature coefficient of V_F $I_F = 30\text{ mA}; -10\text{ °C} \leq T \leq 100\text{ °C}$	(typ.) TC_V	- 3.1	- 3.2	- 3.6	mV/K
Optischer Wirkungsgrad Optical efficiency $I_F = 30\text{ mA}$	(typ.) η_{opt}	3	10	13	lm/W

¹⁾ Wellenlängengruppen werden mit einer Stromeinprägedauer von 25 ms und einer Genauigkeit von $\pm 1\text{ nm}$ ermittelt.
Wavelength groups are tested at a current pulse duration of 25 ms and a tolerance of $\pm 1\text{ nm}$.

²⁾ Spannungswerte werden mit einer Stromeinprägedauer von 1 ms und einer Genauigkeit von $\pm 0,1\text{ V}$ ermittelt.
Voltages are tested at a current pulse duration of 1 ms and a tolerance of $\pm 0.1\text{ V}$.

1) Wellenlängengruppen / Wavelength groups

Gruppe Group	blue		verde		true green		Einheit Unit
	min.	max.	min.	max.	min.	max.	
3	463	467	497	501	516	522	nm
4	467	471	501	505	522	528	nm
5	471	475	505	509	528	534	nm

Helligkeits-Gruppierungsschema
Luminous Intensity Groups

Lichtgruppe Luminous Intensity Group	Lichtstärke Luminous Intensity I_V (mcd)	Lichtstrom Luminous Flux Φ_V (lm)
P2	56 ... 71	190 (typ.)
Q1	71 ... 90	240 (typ.)
Q2	90 ... 112	300 (typ.)
R1	112 ... 140	380 (typ.)
R2	140 ... 180	480 (typ.)
S1	180 ... 224	600 (typ.)
S2	224 ... 280	760 (typ.)
T1	280 ... 355	950 (typ.)
T2	355 ... 450	1200 (typ.)
U1	450 ... 560	1500 (typ.)
U2	560 ... 710	1900 (typ.)
V1	710 ... 900	2400 (typ.)

Helligkeitswerte werden mit einer Stromeinprägedauer von 25 ms und einer Genauigkeit von $\pm 11\%$ ermittelt.
Luminous intensity is tested at a current pulse duration of 25 ms and a tolerance of $\pm 11\%$.

Gruppenbezeichnung auf Etikett
Group Name on Label

Beispiel: S2-3

Example: S2-3

Lichtgruppe Luminous Intensity Group	Halbgruppe Half Group	Wellenlänge Wavelength
S	2	3

Relative spektrale Emission $I_{rel} = f(\lambda)$, $T_A = 25\text{ }^\circ\text{C}$, $I_F = 30\text{ mA}$

Relative Spectral Emission

$V(\lambda)$ = spektrale Augenempfindlichkeit
Standard eye response curve

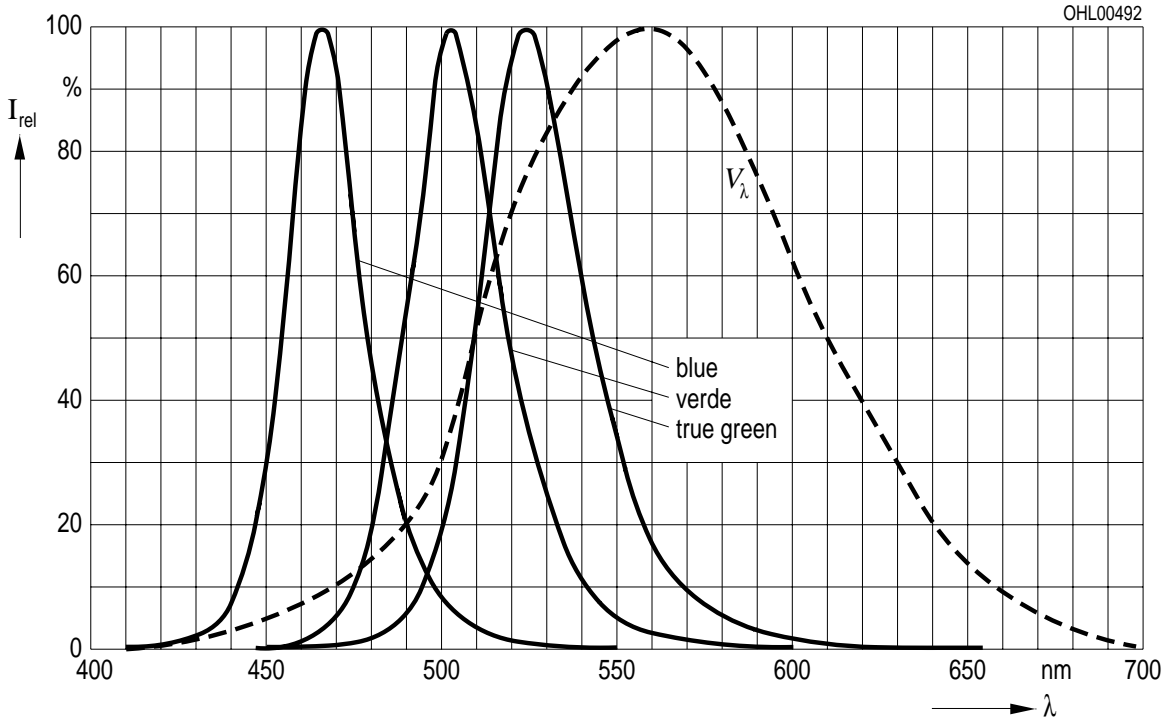

Abstrahlcharakteristik $I_{rel} = f(\varphi)$

Radiation Characteristic

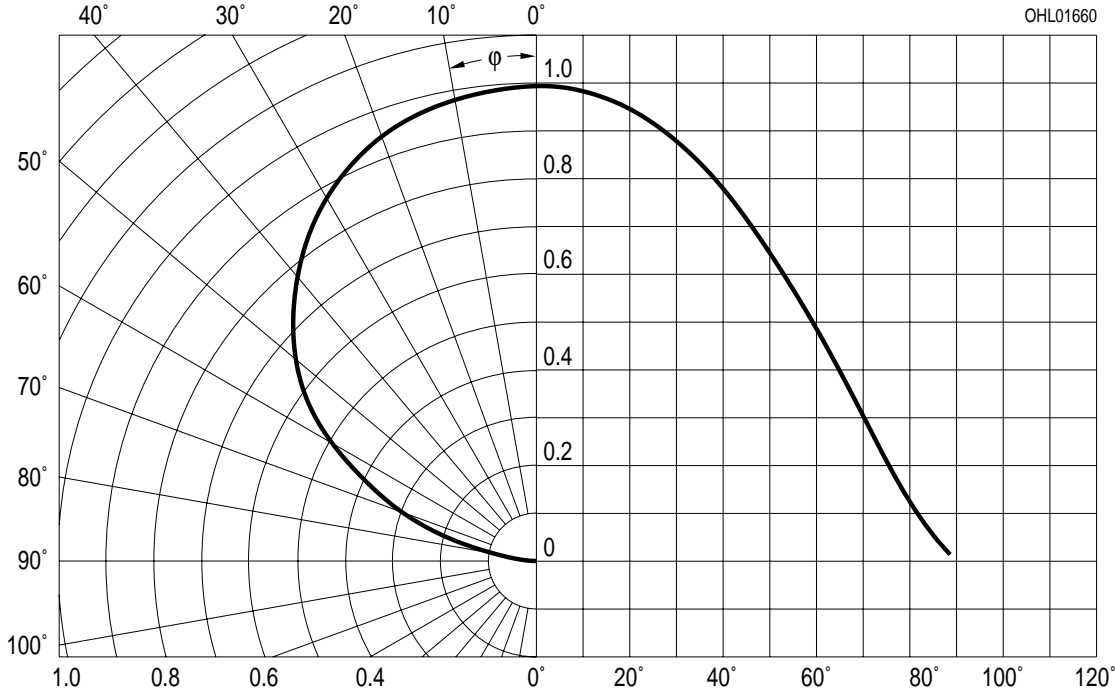

Durchlassstrom $I_F = f(V_F)$
Forward Current

$T_A = 25\text{ °C}$

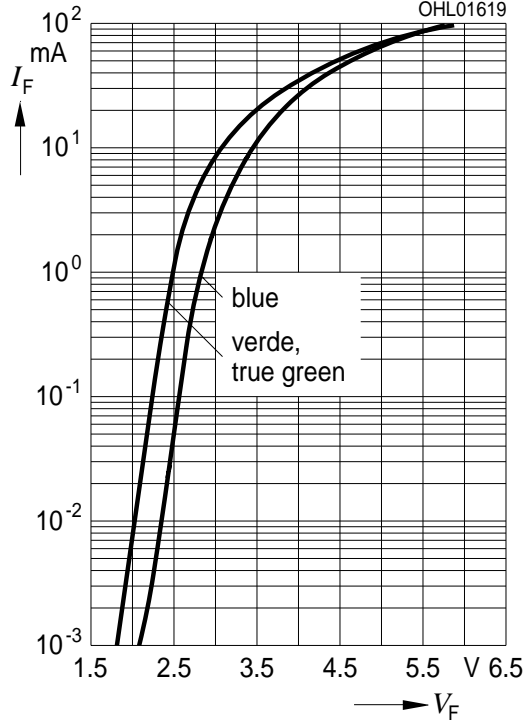

Relative Lichtstärke $I_V/I_{V(30\text{ mA})} = f(I_F)$
Relative Luminous Intensity

$T_A = 25\text{ °C}$

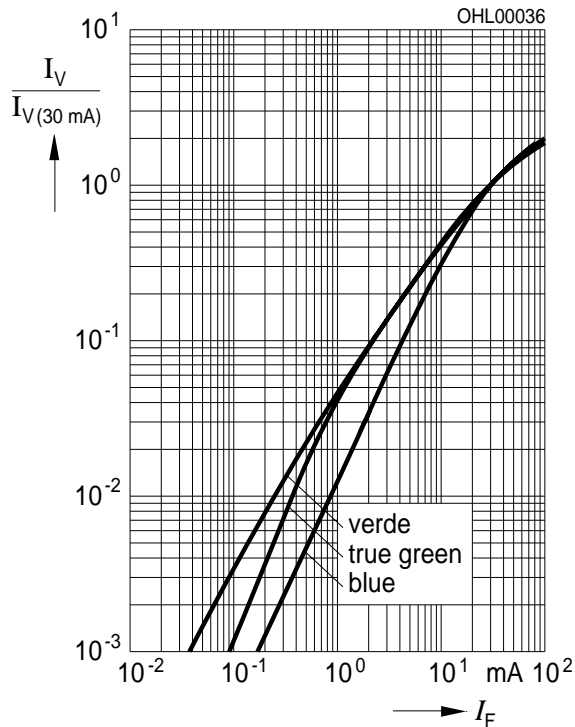

Maximal zulässiger Durchlassstrom $I_F = f(T)$
Max. Permissible Forward Current

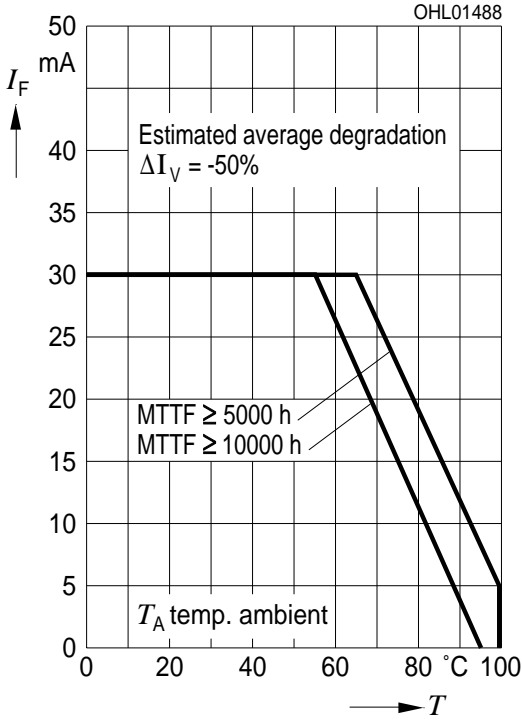

Maximal zulässiger Durchlassstrom $I_F = f(T)$
Max. Permissible Forward Current

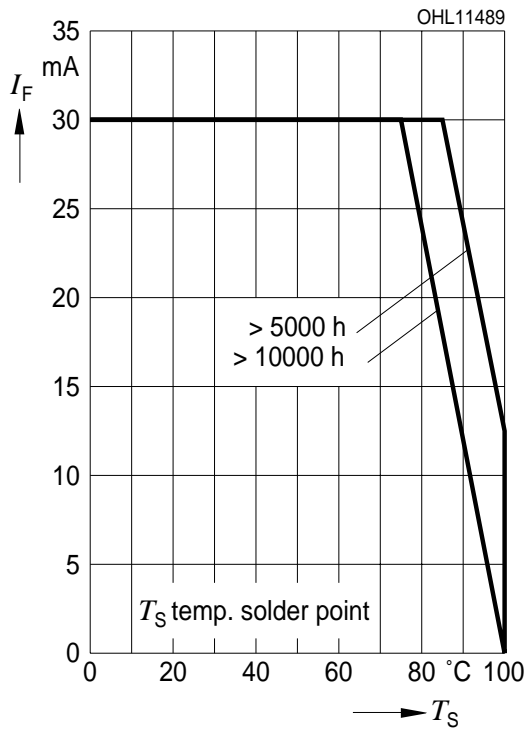

Relative Lichtstärke $I_V/I_{V(25\text{ °C})} = f(T_A)$
 Relative Luminous Intensity

$I_F = 30\text{ mA}$

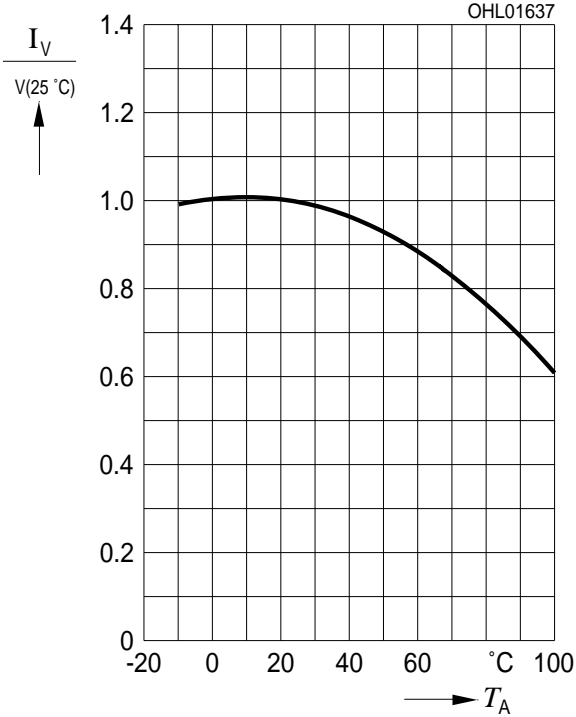

Dominante Wellenlänge $\lambda_{\text{dom}} = f(I_F)$
 Dominant Wavelength

LB, $T_A = 25\text{ °C}$

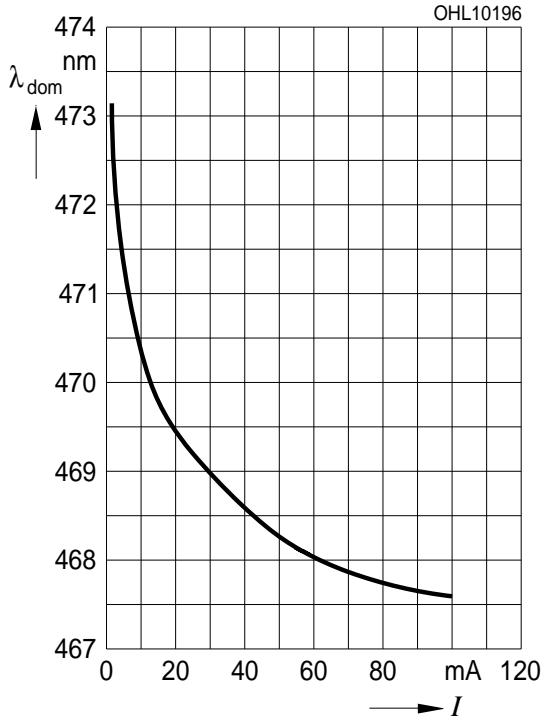

Dominante Wellenlänge $\lambda_{\text{dom}} = f(I_F)$
 Dominant Wavelength

LV, $T_A = 25\text{ °C}$

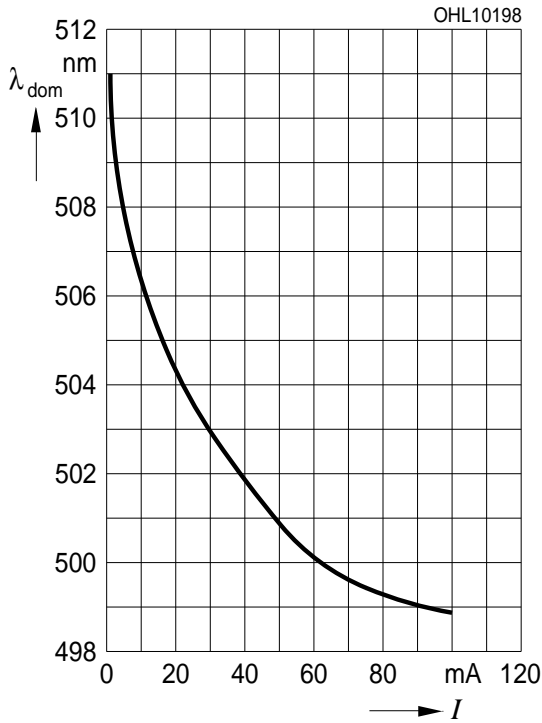

Dominante Wellenlänge $\lambda_{\text{dom}} = f(I_F)$
 Dominant Wavelength

LT, $T_A = 25\text{ °C}$

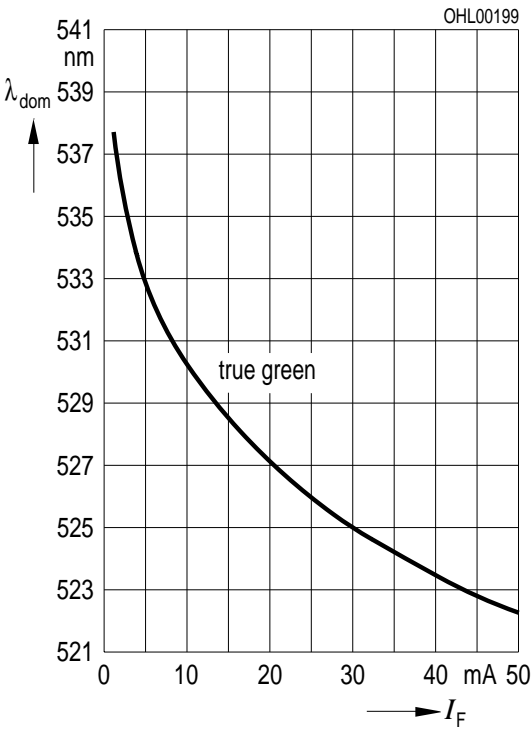

Zulässige Impulsbelastbarkeit $I_F = f(t_p)$
Permissible Pulse Handling Capability
 Duty cycle $D =$ parameter, $T_A = 25\text{ °C}$
LB

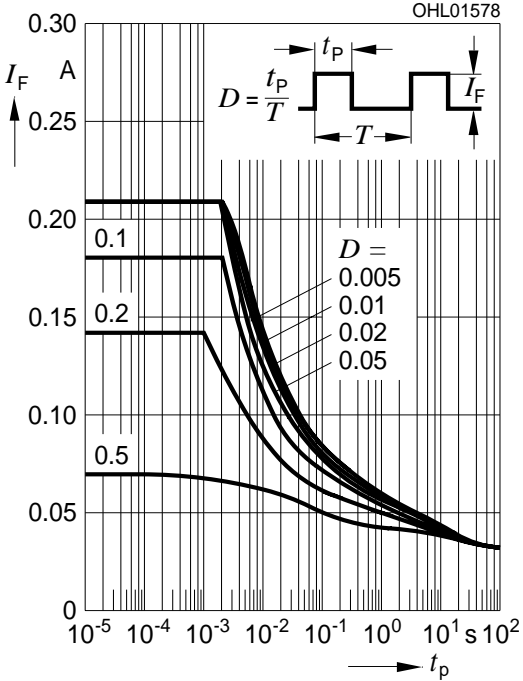

Zulässige Impulsbelastbarkeit $I_F = f(t_p)$
Permissible Pulse Handling Capability
 Duty cycle $D =$ parameter, $T_A = 85\text{ °C}$
LB

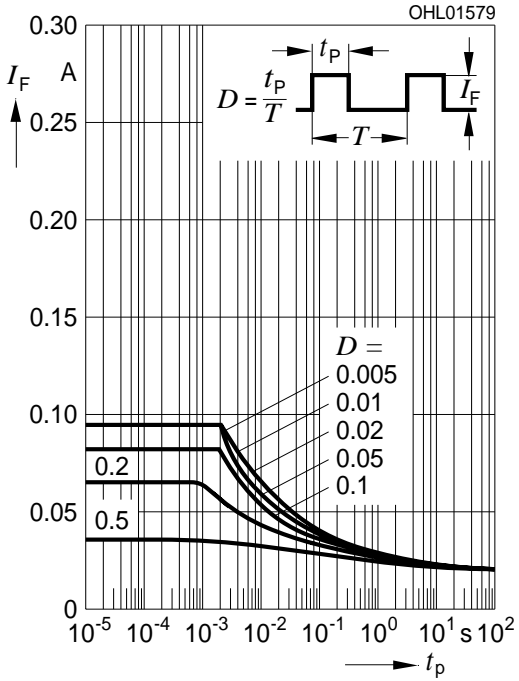

Zulässige Impulsbelastbarkeit $I_F = f(t_p)$
Permissible Pulse Handling Capability
 Duty cycle $D =$ parameter, $T_A = 25\text{ °C}$
LT / LV

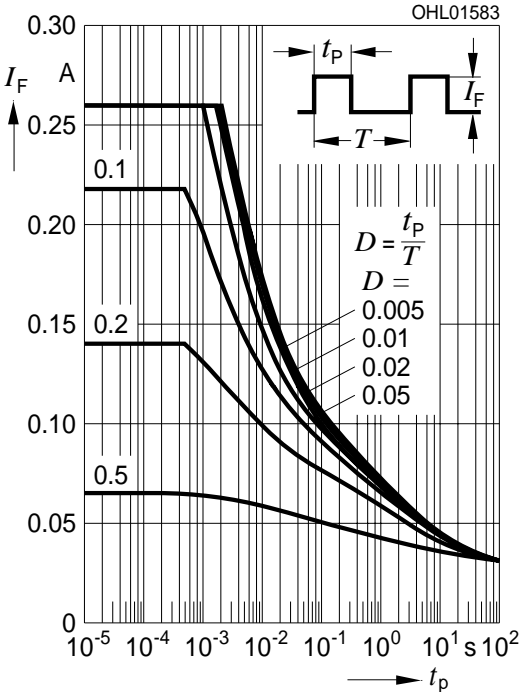

Zulässige Impulsbelastbarkeit $I_F = f(t_p)$
Permissible Pulse Handling Capability
 Duty cycle $D =$ parameter, $T_A = 85\text{ °C}$
LT / LV

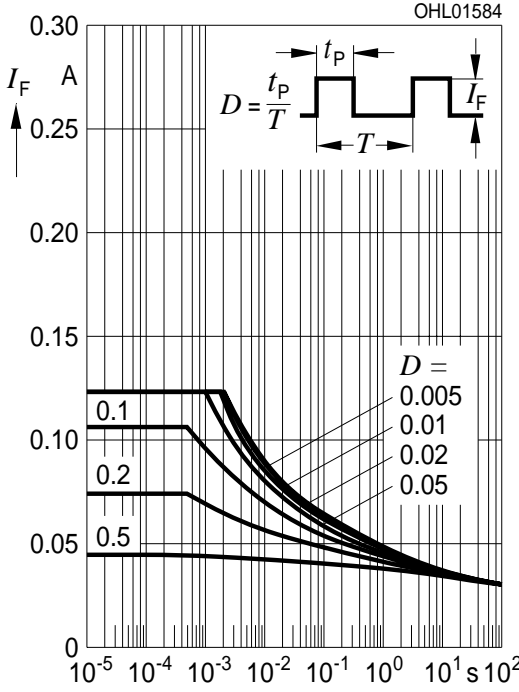

Maßzeichnung
Package Outlines

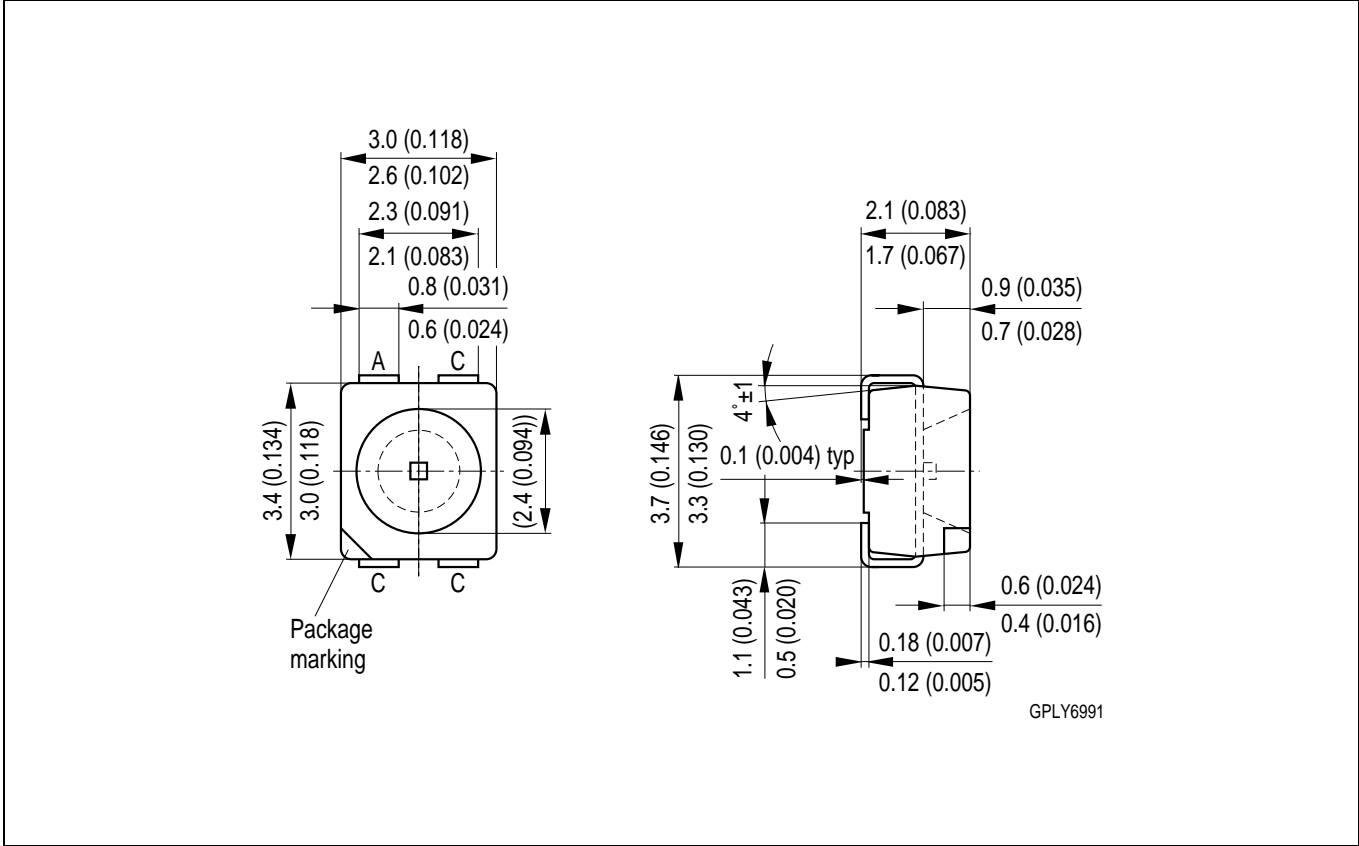

Maße werden wie folgt angegeben: mm (inch) / Dimensions are specified as follows: mm (inch).

Gewicht / Approx. weight: 31 mg

Lötbedingungen Vorbehandlung nach JEDEC Level 2
Soldering Conditions Preconditioning acc. to JEDEC Level 2

IR-Reflow Lötprofil (nach IPC 9501)
IR Reflow Soldering Profile (acc. to IPC 9501)

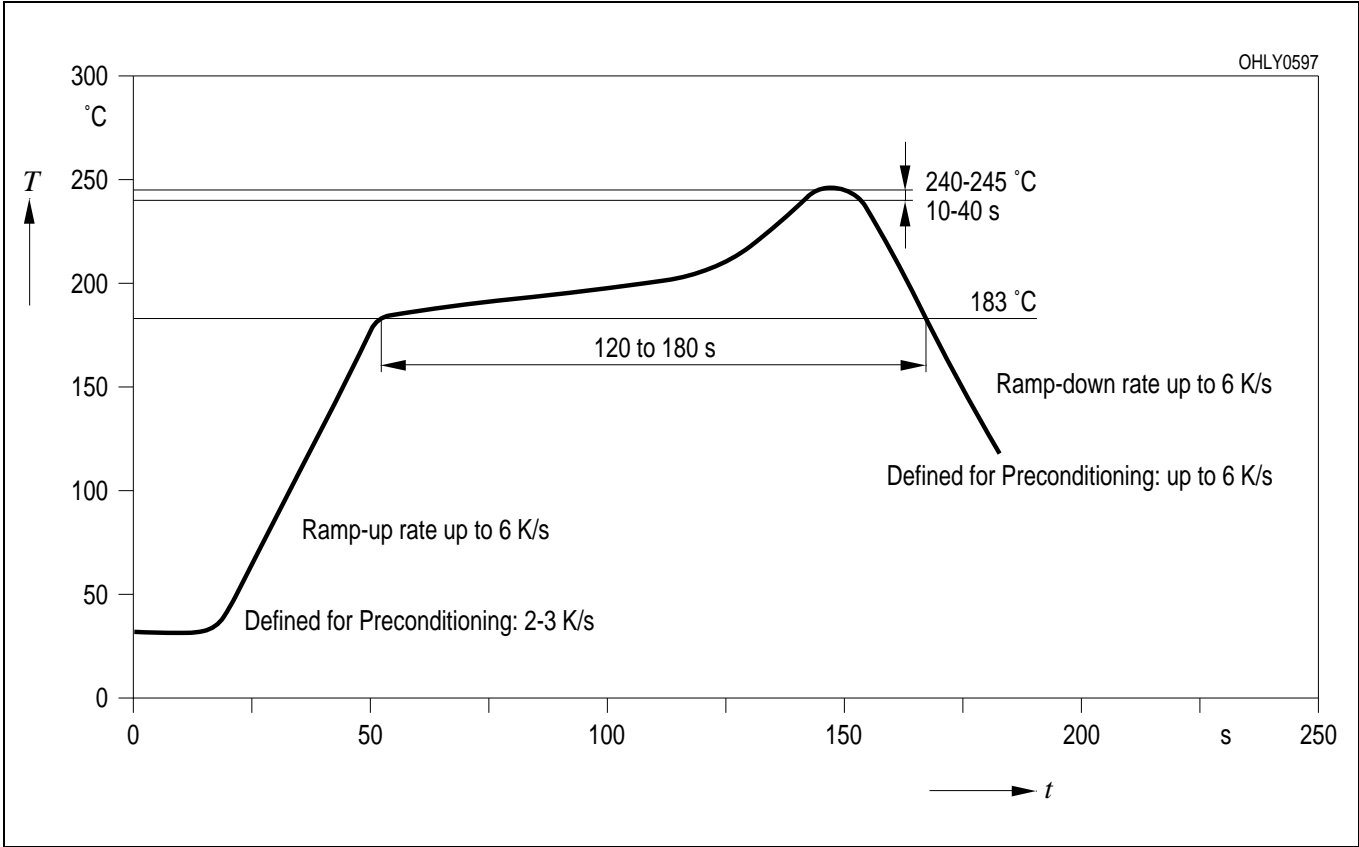

Wellenlöten (TTW) (nach CECC 00802)
TTW Soldering (acc. to CECC 00802)

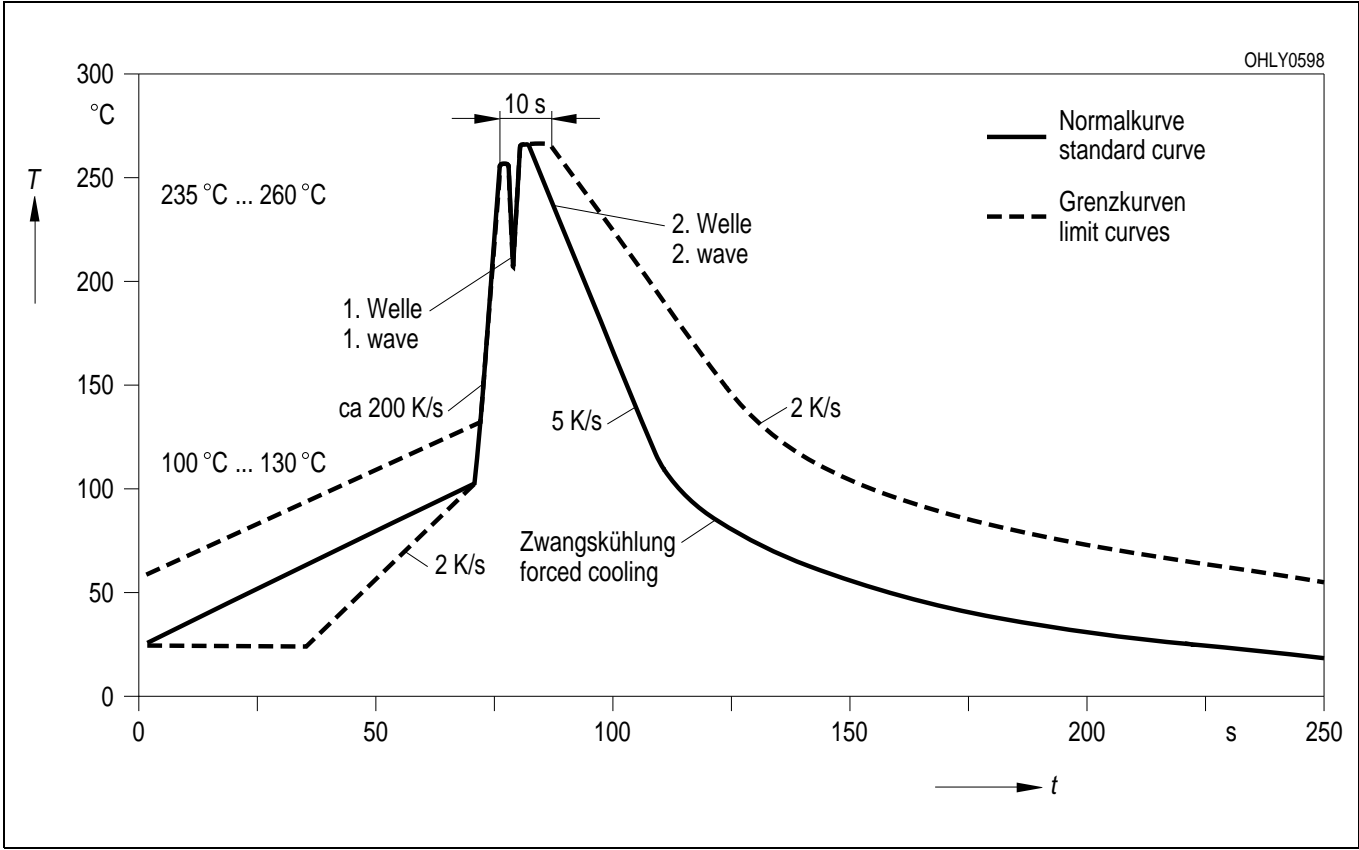

Empfohlenes Lötpad Design IR Reflow Löten
Recommended Solder Pad IR Reflow Soldering

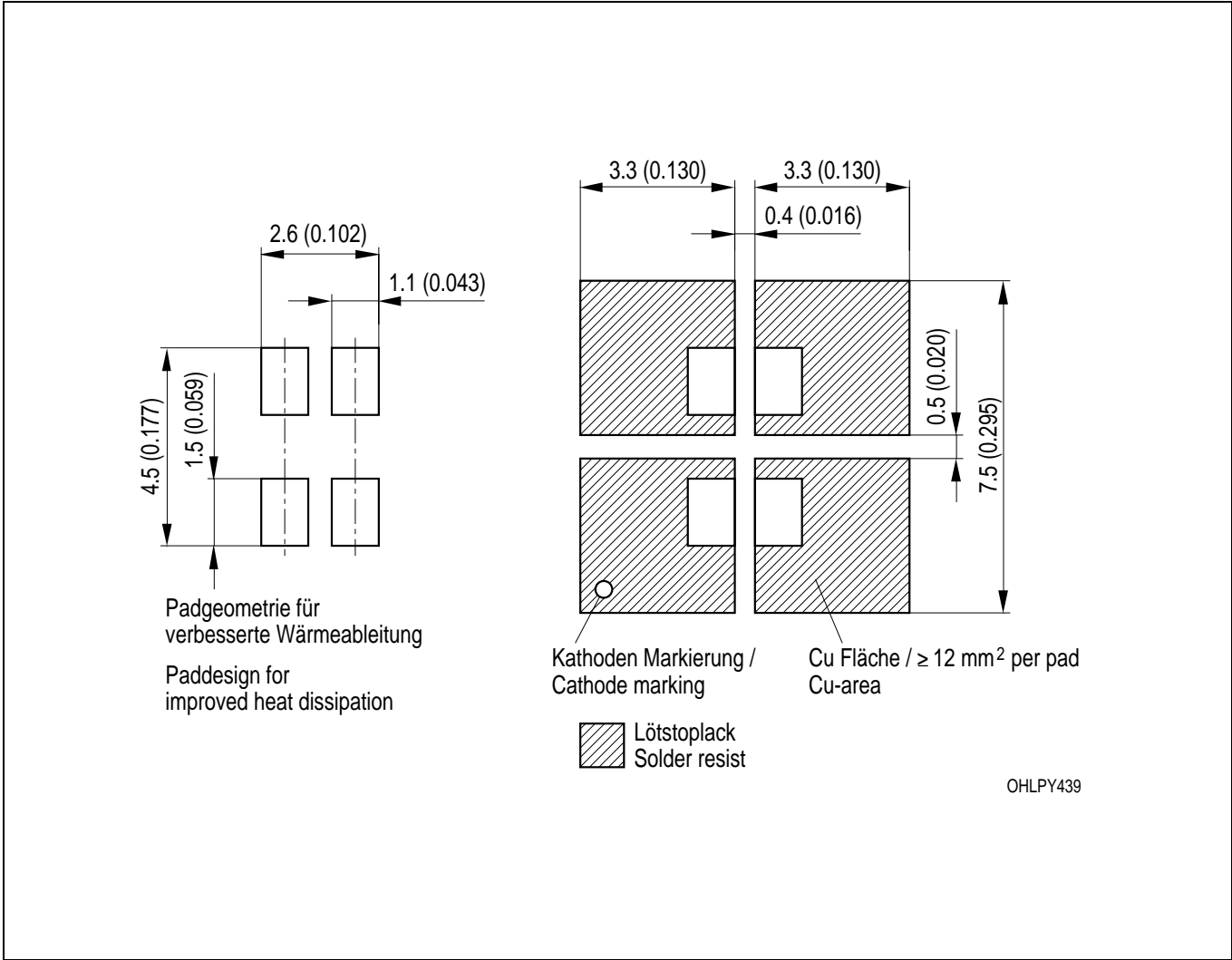

Maße werden wie folgt angegeben: mm (inch) / Dimensions are specified as follows: mm (inch).

Empfohlenes Lötpaddesign Wellenlöten (TTW)
Recommended Solder Pad TTW Soldering

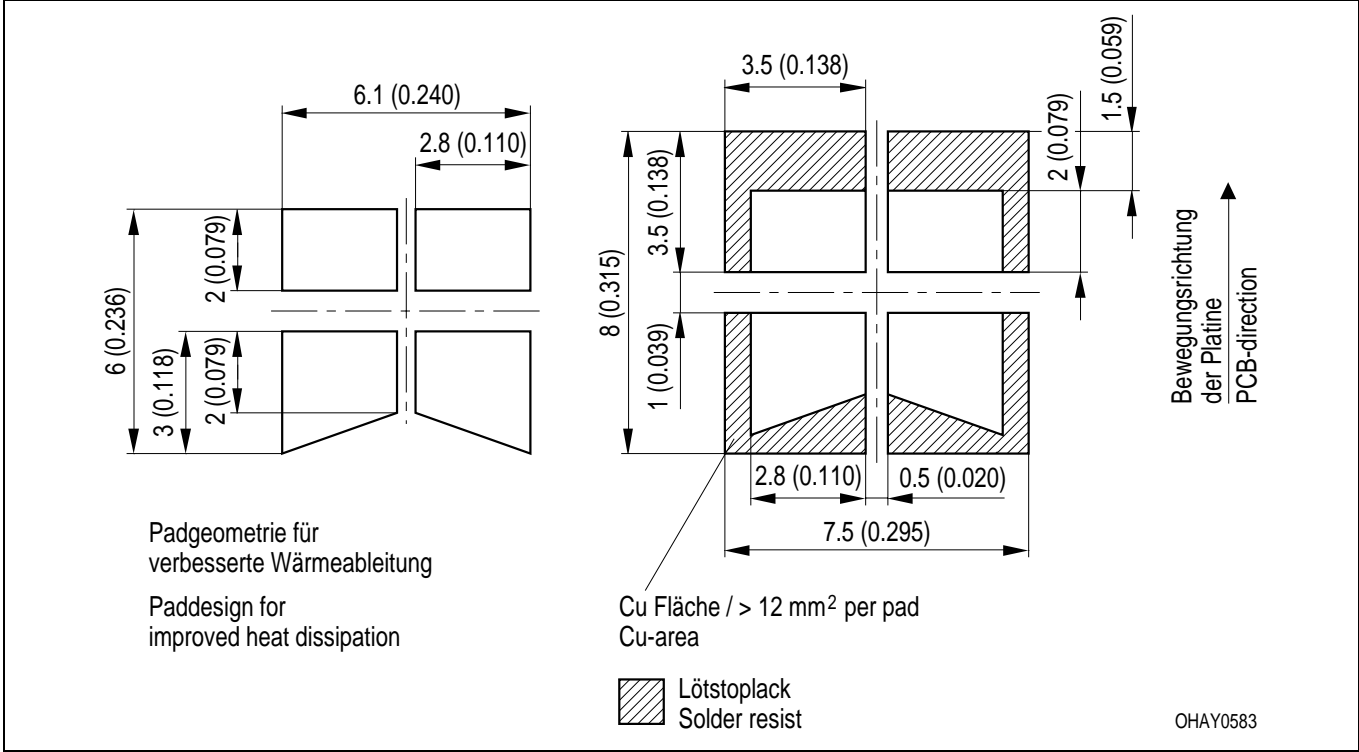

Maße werden wie folgt angegeben: mm (inch) / Dimensions are specified as follows: mm (inch).

Gurtung / Polarität und Lage

Verpackungseinheit 2000/Rolle, ø180 mm
 oder 8000/Rolle, ø330 mm

Method of Taping / Polarity and Orientation

Packing unit 2000/reel, ø180 mm
 or 8000/reel, ø330 mm

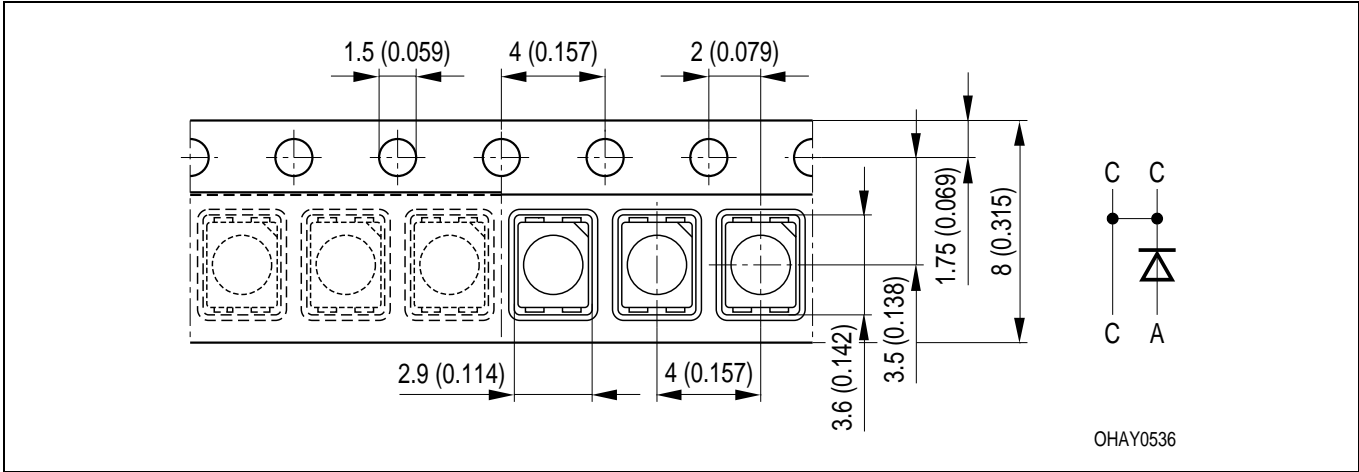

Maße werden wie folgt angegeben: mm (inch) / Dimensions are specified as follows: mm (inch).

Revision History: 2002-07-17		Date of change
Previous Version: 2002-07-02		
Page	Subjects (major changes since last revision)	
4	value (forward voltage)	
7	diagram OHL01569/01570 to OHL01488/11489	
8	diagram OHL01620/01627/01621 to OHL10196/10198/00199	
2	wavelength grouping for blue, true green and verde	
2	brightness grouping for LV E63C	2002-07-17

Published by OSRAM Opto Semiconductors GmbH & Co. OHG
Wernerwerkstrasse 2, D-93049 Regensburg
© All Rights Reserved.

Attention please!

The information describes the type of component and shall not be considered as assured characteristics. Terms of delivery and rights to change design reserved. Due to technical requirements components may contain dangerous substances. For information on the types in question please contact our Sales Organization. If printed or downloaded, please find the latest version in the Internet.

Packing

Please use the recycling operators known to you. We can also help you – get in touch with your nearest sales office. By agreement we will take packing material back, if it is sorted. You must bear the costs of transport. For packing material that is returned to us unsorted or which we are not obliged to accept, we shall have to invoice you for any costs incurred.

Components used in life-support devices or systems must be expressly authorized for such purpose! Critical components ¹ may only be used in life-support devices or systems ² with the express written approval of OSRAM OS.

¹ A critical component is a component used in a life-support device or system whose failure can reasonably be expected to cause the failure of that life-support device or system, or to affect its safety or the effectiveness of that device or system.

² Life support devices or systems are intended (a) to be implanted in the human body, or (b) to support and/or maintain and sustain human life. If they fail, it is reasonable to assume that the health of the user may be endangered.