

# ASM3P2183A

## EMI Reduction IC

### Description

The ASM3P2183A is a versatile spread spectrum frequency modulator designed specifically for a wide range of input clock frequencies from 6 MHz to 90 MHz. (Refer to *Input Frequency and Modulation Rate Table*). The ASM3P2183A can generate an EMI reduced clock from an OSC or a system generated clock. The ASM3P2183A offers a Down Spread clock with a percentage deviation of  $-1.25\%$  and a Center Spread clock with a percentage deviation of  $\pm 0.42\%$ .

The ASM3P2183A reduces electromagnetic interference (EMI) at the clock source, allowing system wide reduction of EMI of down stream clock and data dependent signals. The ASM3P2183A allows significant system cost savings by reducing the number of circuit board layers ferrite beads, shielding and other passive components that are traditionally required to pass EMI regulations.

The ASM3P2183A uses the most efficient and optimized modulation profile approved by the FCC and is implemented in a proprietary all digital method.

The ASM3P2183A modulates the output of a single PLL in order to “spread” the bandwidth of a synthesized clock, and more importantly, decreases the peak amplitudes of its harmonics. This results in significantly lower system EMI compared to the typical narrow band signal produced by oscillators and most frequency generators. Lowering EMI by increasing a signal’s bandwidth is called ‘spread spectrum clock generation.’

### Applications

The ASM3P2183A is targeted towards EMI management for memory and LVDS interfaces in mobile graphic chipsets and high-speed digital applications such as PC peripheral devices, consumer electronics, and embedded controller systems.

### Features

- FCC Approved Method of EMI Attenuation
- Provides up to 15 dB EMI Reduction
- Generates a 1X Low EMI Spread Spectrum Clock of the Input Frequency
- Input Frequency Range: 6 MHz to 90 MHz
- Internal Loop Filter Minimizes External Components and Board Space
- Selectable Spread Options: Down and Center Spread
- 2 Spread Frequency Deviation Selections:  $-1.25\%$  or  $\pm 0.42\%$
- Low Inherent Cycle-to-Cycle Jitter
- Supply Voltage:  $3.3\text{ V} \pm 0.3\text{ V}$
- Low Power CMOS Design
- Supports Notebook VGA and Other LCD Timing Controller Applications
- Products are Available for Industrial Temperature Range
- Available in 8-pin SOIC and TSSOP Packages
- These are Pb-Free Devices



ON Semiconductor®

<http://onsemi.com>



SOIC-8  
S SUFFIX  
CASE 751BD



TSSOP-8  
T SUFFIX  
CASE 948AL

### PIN CONFIGURATION

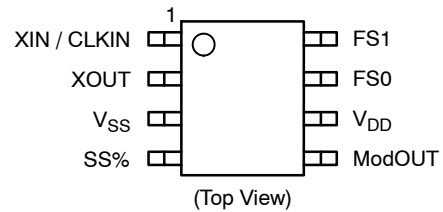

### ORDERING INFORMATION

See detailed ordering and shipping information in the package dimensions section on page 6 of this data sheet.

# ASM3P2183A

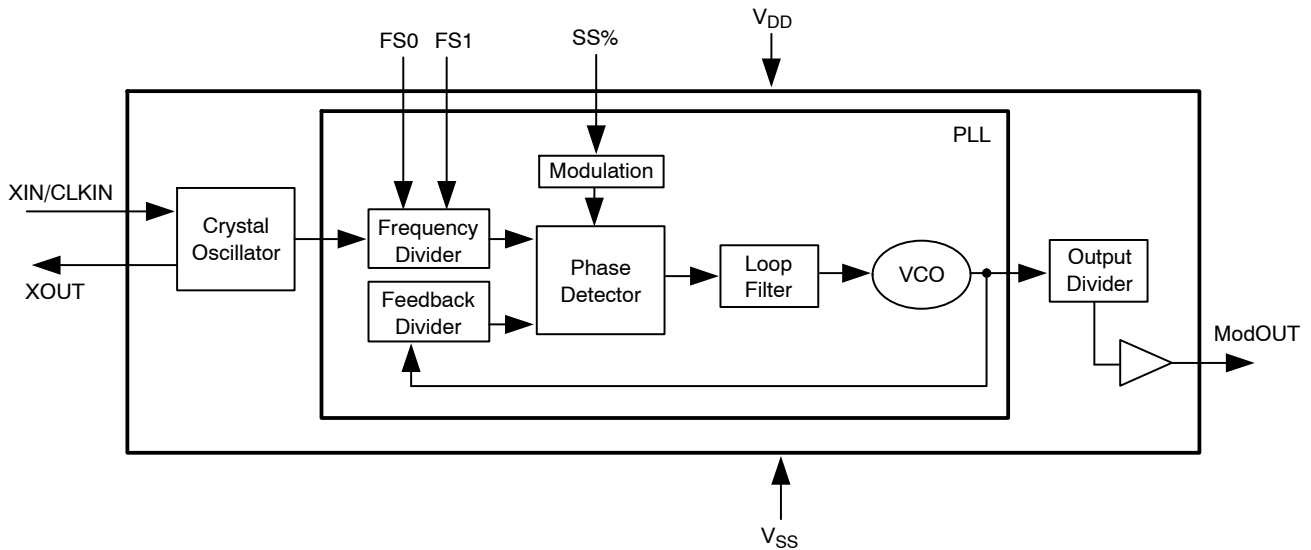

Figure 1. Block Diagram

Table 1. PIN DESCRIPTION

Pin#	Pin Name	Type	Description
1	XIN / CLKIN	I	Crystal connection or external frequency input. This pin has dual functions. It can be connected to either an external crystal or an external reference clock.
2	XOUT	I	Crystal connection. Input connection for an external crystal. If using an external reference, this pin must be left unconnected.
3	V <sub>SS</sub>	P	Ground to entire chip.
4	SS%	I	Spread range select. Digital logic input used to select frequency deviation (Refer to <i>Spread Deviation Selection Table</i> ). This pin has an internal pull-up resistor.
5	ModOUT	O	Spread spectrum low EMI output.
6	V <sub>DD</sub>	P	Power supply for the entire chip.
7	FS0	I	Frequency range select. Digital logic input used to select frequency range (Refer to <i>Input Frequency and Modulation Rate Table</i> ). This pin has an internal pull-up resistor.
8	FS1	I	Frequency range select. Digital logic input used to select frequency range (Refer to <i>Input Frequency and Modulation Rate Table</i> ). This pin has an internal pull-up resistor.

Table 2. INPUT FREQUENCY AND MODULATION RATE TABLE

FS1 (pin 8)	FS0 (pin 7)	Frequency Range
0	0	6 MHz to 13 MHz
0	1	12 MHz to 25 MHz
1	0	25 MHz to 50 MHz
1	1	50 MHz to 90 MHz

Table 3. SPREAD DEVIATION SELECTION TABLE

SS% (pin 4)	Spread Deviation (%)
0	- 1.25
1	± 0.42

# ASM3P2183A

**Table 4. ABSOLUTE MAXIMUM RATINGS**

Symbol	Parameter	Rating	Unit
V <sub>DD</sub> , V <sub>IN</sub>	Voltage on any pin with respect to Ground	-0.5 to +4.6	V
T <sub>STG</sub>	Storage temperature	-65 to +125	°C
T <sub>s</sub>	Max. Soldering Temperature (10 sec)	260	°C
T <sub>J</sub>	Junction Temperature	150	°C
T <sub>DV</sub>	Static Discharge Voltage (As per JEDEC STD22- A114-B)	2	KV

Stresses exceeding Maximum Ratings may damage the device. Maximum Ratings are stress ratings only. Functional operation above the Recommended Operating Conditions is not implied. Extended exposure to stresses above the Recommended Operating Conditions may affect device reliability.

**Table 5. RECOMMENDED OPERATING CONDITIONS**

Symbol	Parameter	Min	Typ	Max	Unit
T <sub>A</sub>	Operating Temperature	0		+70	°C
V <sub>DD</sub>	Core Voltage	+3.0	+3.3	+3.6	V

**Table 6. DC ELECTRICAL CHARACTERISTICS**

Symbol	Parameter	Min	Typ	Max	Unit
V <sub>IL</sub>	Input low voltage	V <sub>SS</sub> - 0.3	-	0.8	V
V <sub>IH</sub>	Input high voltage	2.0	-	V <sub>DD</sub> + 0.3	V
I <sub>IL</sub>	Input low current	-	-	-35	μA
I <sub>IH</sub>	Input high current	-	-	35	μA
I <sub>XOL</sub>	XOUT Output low current (@ 0.4 V, V <sub>DD</sub> = 3.3 V)	-	3	-	mA
I <sub>XOH</sub>	XOUT Output high current (@ 2.5 V, V <sub>DD</sub> = 3.3 V)	-	3	-	mA
V <sub>OL</sub>	Output low voltage (V <sub>DD</sub> = 3.3 V, I <sub>OL</sub> = 20 mA)	-	-	0.4	V
V <sub>OH</sub>	Output high voltage (V <sub>DD</sub> = 3.3 V, I <sub>OH</sub> = 20 mA)	2.5	-	-	V
I <sub>CC</sub>	Dynamic supply current Normal mode (3.3 V, 90 MHz and 10 pF loading)	-	28	-	mA
I <sub>DD</sub>	Static supply current (Note 1)	-	7.0	-	mA
V <sub>DD</sub>	Operating voltage	3.0	3.3	3.6	V
t <sub>ON</sub>	Power up time (first locked clock cycle after power up)	-	0.18	-	mS
Z <sub>OUT</sub>	Clock out impedance	-	50	-	Ω

1. XIN /CLKIN pin is pulled low.

**Table 7. AC ELECTRICAL CHARACTERISTICS**

Symbol	Parameter	Min	Typ	Max	Unit
f <sub>IN</sub>	Input frequency	6	-	90	MHz
ModOUT	Output frequency	6	-	90	MHz
t <sub>LH</sub> (Note 2)	Output rise time (measured at 0.8 V to 2.0 V)	0.3	0.9	1.1	nS
t <sub>HL</sub> (Note 2)	Output fall time (measured at 2.0 V to 0.8 V)	0.5	1.0	1.2	nS
t <sub>JC</sub>	Jitter (cycle to cycle)	-	-	200	pS
T <sub>D</sub>	Output duty cycle	45	50	55	%

2. t<sub>LH</sub> and t<sub>HL</sub> are measured with a capacitive load of 15 pF at 27 MHz.

# ASM3P2183A

## PACKAGE DIMENSIONS

TSSOP8, 4.4x3  
CASE 948AL-01  
ISSUE O

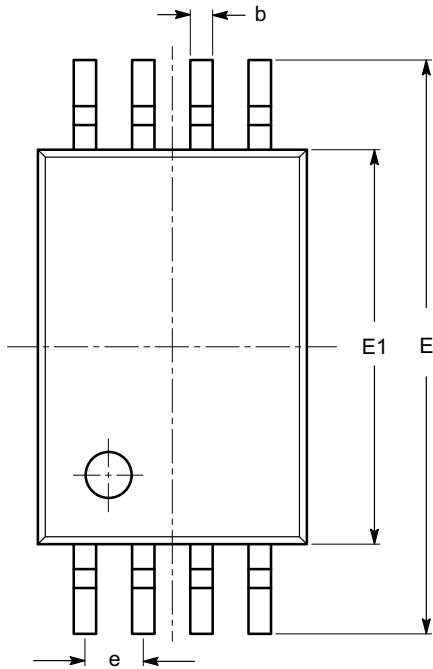

SYMBOL	MIN	NOM	MAX
A			1.20
A1	0.05		0.15
A2	0.80	0.90	1.05
b	0.19		0.30
c	0.09		0.20
D	2.90	3.00	3.10
E	6.30	6.40	6.50
E1	4.30	4.40	4.50
e	0.65 BSC		
L	1.00 REF		
L1	0.50	0.60	0.75
$\theta$	0°		8°

TOP VIEW

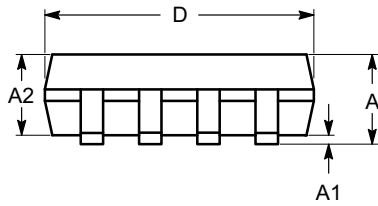

SIDE VIEW

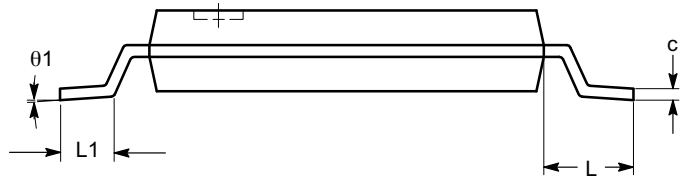

END VIEW

### Notes:

- (1) All dimensions are in millimeters. Angles in degrees.
- (2) Complies with JEDEC MO-153.

# ASM3P2183A

## PACKAGE DIMENSIONS

SOIC 8, 150 mils  
CASE 751BD-01  
ISSUE O

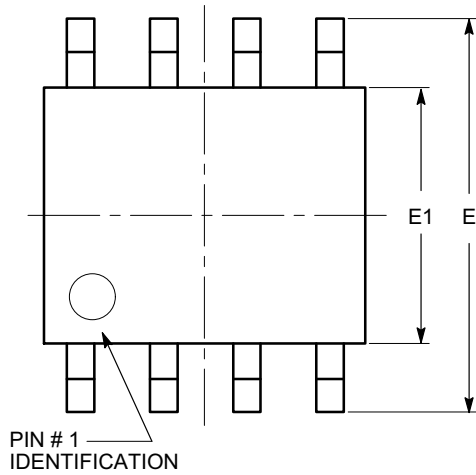

TOP VIEW

SYMBOL	MIN	NOM	MAX
A	1.35		1.75
A1	0.10		0.25
b	0.33		0.51
c	0.19		0.25
D	4.80		5.00
E	5.80		6.20
E1	3.80		4.00
e	1.27 BSC		
h	0.25		0.50
L	0.40		1.27
$\theta$	0°		8°

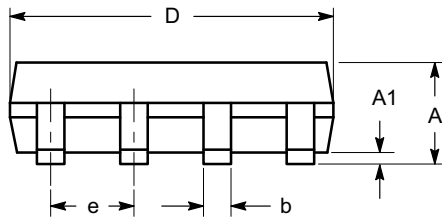

SIDE VIEW

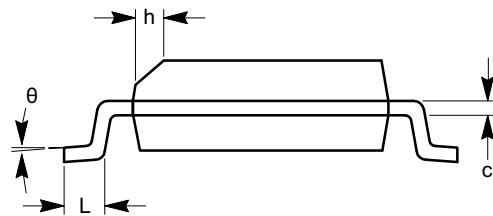

END VIEW

**Notes:**

- (1) All dimensions are in millimeters. Angles in degrees.
- (2) Complies with JEDEC MS-012.

# ASM3P2183A

**Table 8. ORDERING INFORMATION**

Part Number	Marking	Package Type	Temperature
ASM3P2183A-08ST	3P2183A	8-Pin SOIC, TUBE	Commercial
ASM3P2183A-08SR	3P2183A	8-Pin SOIC, TAPE & REEL	Commercial
ASM3P2183A-08TT	3P2183A	8-Pin TSSOP, TUBE	Commercial
ASM3P2183A-08TR	3P2183A	8-Pin TSSOP, TAPE & REEL	Commercial
ASM3P2183AF-08ST	3P2183AF	8-Pin SOIC, TUBE, Pb Free	Commercial
ASM3P2183AF-08SR	3P2183AF	8-Pin SOIC, TAPE & REEL, Pb Free	Commercial
ASM3P2183AF-08TT	3P2183AF	8-Pin TSSOP, TUBE, Pb Free	Commercial
ASM3P2183AF-08TR	3P2183AF	8-Pin TSSOP, TAPE & REEL, Pb Free	Commercial
ASM3P2183AG-08ST	3P2183AG	8-Pin SOIC, TUBE, Green	Commercial
ASM3P2183AG-08SR	3P2183AG	8-Pin SOIC, TAPE & REEL, Green	Commercial
ASM3P2183AG-08TT	3P2183AG	8-Pin TSSOP, TUBE, Green	Commercial
ASM3P2183AG-08TR	3P2183AG	8-Pin TSSOP, TAPE & REEL, Green	Commercial

**ON Semiconductor** and  are registered trademarks of Semiconductor Components Industries, LLC (SCILLC). SCILLC reserves the right to make changes without further notice to any products herein. SCILLC makes no warranty, representation or guarantee regarding the suitability of its products for any particular purpose, nor does SCILLC assume any liability arising out of the application or use of any product or circuit, and specifically disclaims any and all liability, including without limitation special, consequential or incidental damages. "Typical" parameters which may be provided in SCILLC data sheets and/or specifications can and do vary in different applications and actual performance may vary over time. All operating parameters, including "Typicals" must be validated for each customer application by customer's technical experts. SCILLC does not convey any license under its patent rights nor the rights of others. SCILLC products are not designed, intended, or authorized for use as components in systems intended for surgical implant into the body, or other applications intended to support or sustain life, or for any other application in which the failure of the SCILLC product could create a situation where personal injury or death may occur. Should Buyer purchase or use SCILLC products for any such unintended or unauthorized application, Buyer shall indemnify and hold SCILLC and its officers, employees, subsidiaries, affiliates, and distributors harmless against all claims, costs, damages, and expenses, and reasonable attorney fees arising out of, directly or indirectly, any claim of personal injury or death associated with such unintended or unauthorized use, even if such claim alleges that SCILLC was negligent regarding the design or manufacture of the part. SCILLC is an Equal Opportunity/Affirmative Action Employer. This literature is subject to all applicable copyright laws and is not for resale in any manner.

## PUBLICATION ORDERING INFORMATION

### LITERATURE FULFILLMENT:

Literature Distribution Center for ON Semiconductor  
P.O. Box 5163, Denver, Colorado 80217 USA  
**Phone:** 303-675-2175 or 800-344-3860 Toll Free USA/Canada  
**Fax:** 303-675-2176 or 800-344-3867 Toll Free USA/Canada  
**Email:** [orderlit@onsemi.com](mailto:orderlit@onsemi.com)

**N. American Technical Support:** 800-282-9855 Toll Free  
USA/Canada  
**Europe, Middle East and Africa Technical Support:**  
Phone: 421 33 790 2910  
**Japan Customer Focus Center**  
Phone: 81-3-5773-3850

**ON Semiconductor Website:** [www.onsemi.com](http://www.onsemi.com)

**Order Literature:** <http://www.onsemi.com/orderlit>

For additional information, please contact your local Sales Representative