

THIS DRAWING IS UNPUBLISHED. RELEASED FOR PUBLICATION
 © COPYRIGHT BY TYCO ELECTRONICS CORPORATION. ALL INTERNATIONAL RIGHTS RESERVED.

Loc	DIST	REVISIONS					
GP	00	P	LTR	DESCRIPTION	DATE	DWN	APVD
		Y		REVISED PER ECO-09-001588	12JUN2009	CJV	CWR
		Y1		REVISED PER ECO-09-021826	6JAN10	KK	AEG

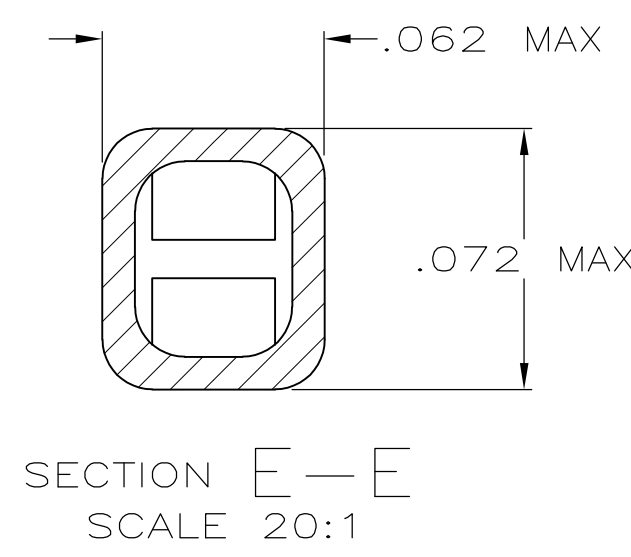
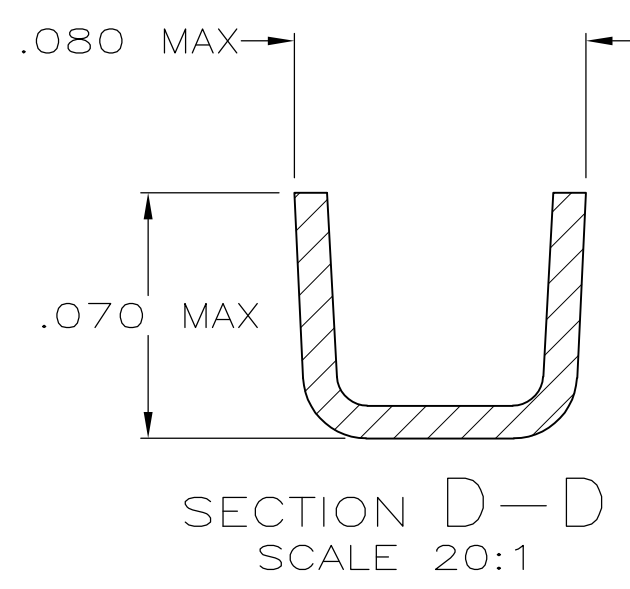
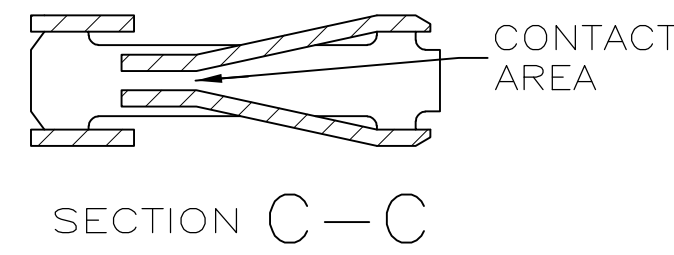
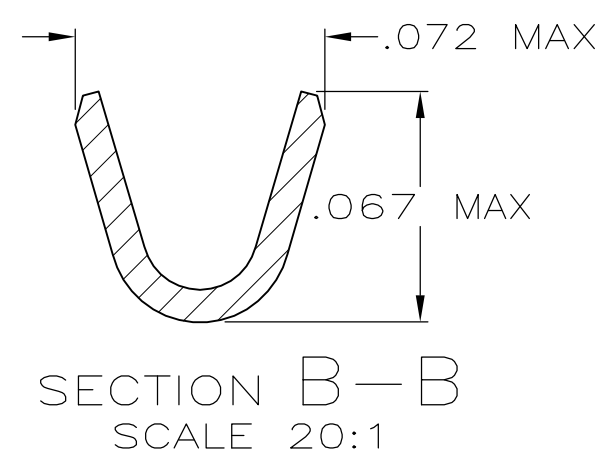
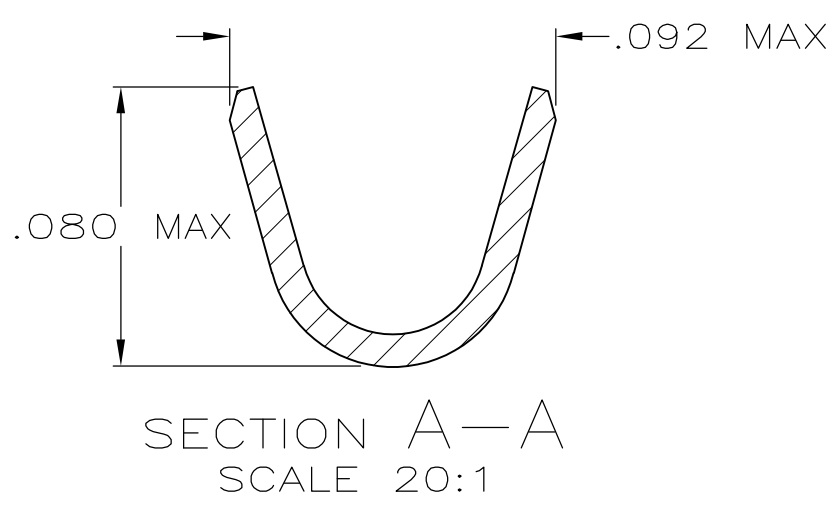
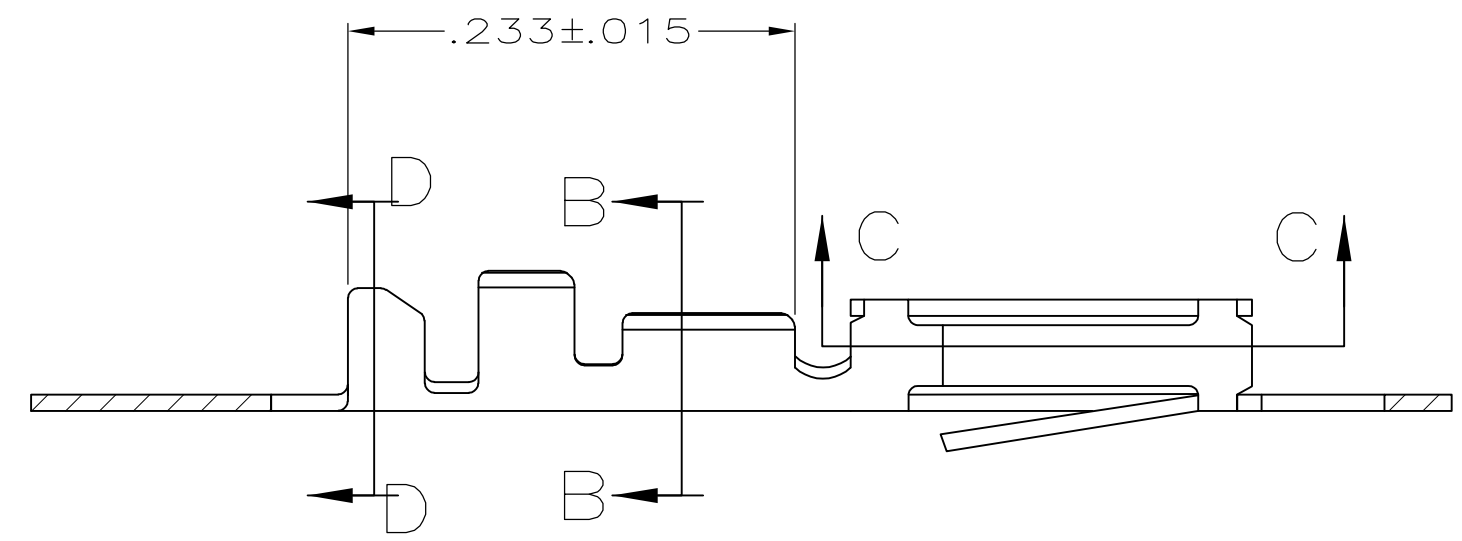
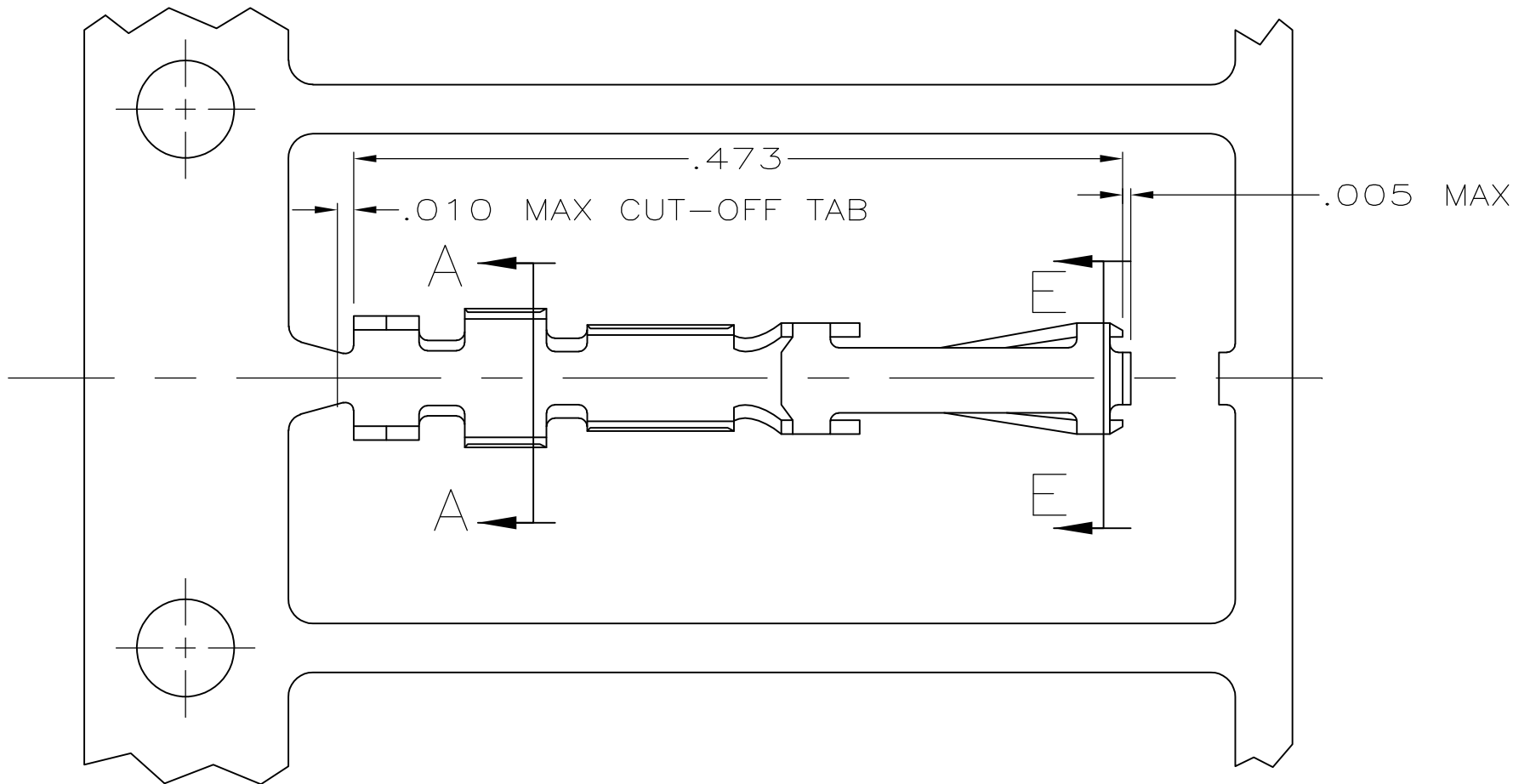

- 1 REELED FOR USE WITH STANDARD APPLICATOR.
- 2 REELED FOR USE WITH MINIATURE APPLICATOR.
- 3 FINISH: GOLD FLASH ALL OVER, .000015 MIN THK GOLD ON LOCALIZED CONTACT PLATING AREA OVER .000050 MIN THK NICKEL ON ENTIRE CONTACT,
-OR-
.000050 MIN THK NICKEL UNDERPLATE ON ENTIRE CONTACT, GOLD FLASH OVER PALLADIUM-NICKEL, .000015 MIN TOTAL THK ON LOCALIZED CONTACT PLATING AREA AND GOLD FLASH OVER REMAINDER OF CONTACT.
- 4 FINISH: GOLD FLASH ALL OVER, .000030 MIN THK GOLD ON LOCALIZED CONTACT PLATING AREA OVER .000050 MIN THK NICKEL ON ENTIRE CONTACT,
-OR-
.000050 MIN THK NICKEL UNDERPLATE ON ENTIRE CONTACT, GOLD FLASH OVER PALLADIUM-NICKEL, .000030 MIN TOTAL THK ON LOCALIZED CONTACT PLATING AREA AND GOLD FLASH OVER REMAINDER OF CONTACT.
- 5 FINISH: GOLD FLASH ALL OVER, .000050 MIN THK GOLD ON LOCALIZED CONTACT PLATING AREA OVER .000050 MIN THK NICKEL ON ENTIRE CONTACT,
-OR-
.000050 MIN THK NICKEL UNDERPLATE ON ENTIRE CONTACT, GOLD FLASH OVER PALLADIUM-NICKEL, .000050 MIN TOTAL THK ON LOCALIZED CONTACT PLATING AREA AND GOLD FLASH OVER REMAINDER OF CONTACT.
- 6 FINISH: .000100 MIN THK BRIGHT TIN-LEAD OVER .000050 MIN THK NICKEL ON ENTIRE CONTACT.
- 7 FINISH: .000030 MIN THK GOLD ON ALL EXTERIOR SURFACES, INSIDE OF RCPT. BOX (EXCLUDING PREPLATED CONTACT AREAS) MAY HAVE .000003 MIN THK GOLD, ALL OVER .000050 MIN THK GOLD ON LOCALIZED CONTACT PLATING AREA OVER .000050 MIN THK NICKEL ON ENTIRE CONTACT.
- 8 FINISH: .000050 MIN THK GOLD ON ALL EXTERIOR SURFACES, INSIDE OF RCPT. BOX (EXCLUDING PREPLATED CONTACT AREAS) MAY HAVE .000003 MIN THK GOLD, ALL OVER .000050 MIN THK GOLD ON LOCALIZED CONTACT PLATING AREA OVER .000050 MIN THK NICKEL ON ENTIRE CONTACT.
- 9. FOR 22-26 AWG WIRE WITH AN INSULATION RANGE OF .040-.056 DIA.
- 10 OBSOLETE PART NUMBER
- 11 FINISH: .000100 MIN THK TIN OVER .000050 MIN THK NICKEL ON ENTIRE CONTACT.
- 12 OBSOLETE PARTS: OBSOLETE CIS STREAMLINING PER D.RENAUD/D.SINISI

12 SUPERCEDED BY 86566-4

11	1-86571-1	2	2-86566-0
7		10	1-86566-9
8		10	1-86566-7
8	1-86571-0	2	1-86566-6
6		10	1-86566-3
5		10	1-86566-2
4		10	1-86566-1
3		10	1-86566-0
6	86571-8	2	86566-8
5	86571-6	2	86566-6
4	86571-4	2	86566-4
3	86571-2	2	86566-2
FINISH		LOOSE PIECE PART NO	
		PART NO	

THIS DRAWING IS A CONTROLLED DOCUMENT.		DWN B. MOYER 6-8-89	Tyco Electronics Corporation Harrisburg, PA 17105-3608	
DIMENSIONS: INCHES		CHK D.L. ROCKER 6-8-89	NAME CONTACT, RCPT., ROUND WIRE, .100 CENTERLINE, FFC	
TOLERANCES UNLESS OTHERWISE SPECIFIED: 0 PLC ± - 1 PLC ± - 2 PLC ± - 3 PLC ± .005 4 PLC ± - ANGLES ± -		APVD G.D. MILLER 6-14-89	PRODUCT SPEC 108-9024	
MATERIAL PHOS. BRONZE		FINISH SEE TABLE	APPLICATION SPEC 114-16003	RESTRICTED TO -
		WEIGHT -	SIZE A2	CAGE CODE 00779
		CUSTOMER DRAWING	DRAWING NO C=86566	SCALE 10:1
			SHEET 1 of 1	REV Y1