

# SMDT-50H

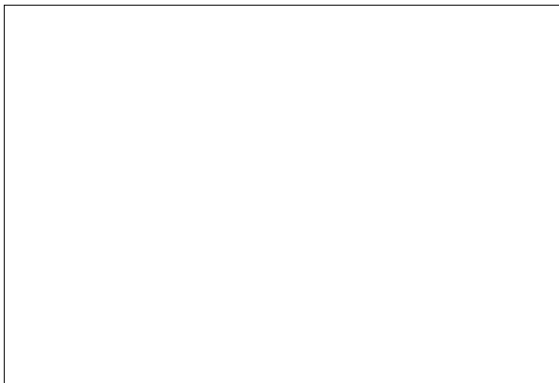

## Diode-Thyristor Module



Type	$V_{RSM}$	$V_{RRM}$ , $V_{DRM}$
SMDT-50H-08	1000	800
SMDT-50H-12	1400	1200
SMDT-50H-14	1600	1400
SMDT-50H-16	1800	1600
SMDT-50H-18	2000	1800
SMDT-50H-20	2200	2000
SMDT-50H-22	2400	2200
SMDT-50H-24	2600	2400

Type	$I_{TAVM}$ , $I_{FAVM}$	$I_{TRMS}$ , $I_{FRMS}$	$T_c$	$I_{TSM}$ , $I_{FSM}$	$(di/dt)_{cr}$	$(dv/dt)_{cr}$	$V_{TM}$	$I_{TM}$ , $I_{FM}$	$V_{TO}$	$r_T$	$t_q$	$V_{GT}$	$I_{GT}$	$T_{VJM}$	$V_{isol}$	$R_{thJC}$
	A	A	°C	kA	A/μs	V/μs	V	A	V	mΩ	μs	V	mA	°C	V	K/W
SMDT-50H	55	100	85	1.3	50	800	1.50	170	0.85	4.9	150	2.5	100	125	2500	0.53

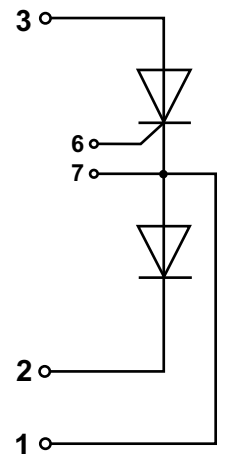
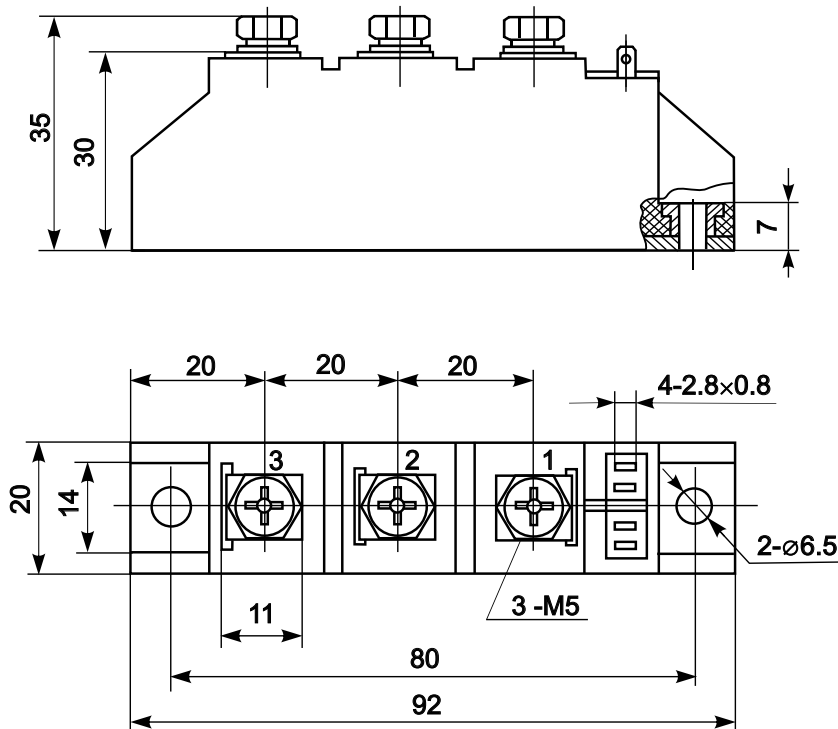

### Features:

- Industrial standard package
- Heat transfer through aluminium nitride ceramic isolated metal baseplate
- Precise internal pressure contacts for high reliability
- 2500V RMS isolation voltage

### Typical Applications:

- DC motor control
- AC motor soft starter
- Temperature control (e.g. for ovens, chemical processes)
- Lighting control