Appendix A - ATmega88 Automotive Automotive specification at 150°C

This document contains information specific to devices operating at temperatures up to 150°C. Only deviations are covered in this appendix, all other information can be found in the complete Automotive datasheet. The complete Automotive datasheet can be found on www.atmel.com



**8-bit AVR[®]
Microcontroller
with 8K Bytes
In-System
Programmable
Flash**

**ATmega88
Automotive**

Appendix A

PRELIMINARY

7607D-AVR-03/07





Electrical Characteristics

Absolute Maximum Ratings*

Operating Temperature.....	-55°C to +150°C
Storage Temperature	-65°C to +175°C
Voltage on any Pin except $\overline{\text{RESET}}$ with respect to Ground	-0.5V to $V_{CC}+0.5V$
Voltage on $\overline{\text{RESET}}$ with respect to Ground.....	-0.5V to +13.0V
Maximum Operating Voltage	6.0V
DC Current per I/O Pin	30.0 mA
DC Current V_{CC} and GND Pins.....	200.0 mA

*NOTICE: Stresses beyond those listed under “Absolute Maximum Ratings” may cause permanent damage to the device. This is a stress rating only and functional operation of the device at these or other conditions beyond those indicated in the operational sections of this specification is not implied. Exposure to absolute maximum rating conditions for extended periods may affect device reliability.

DC Characteristics

$T_A = -40^\circ\text{C}$ to 150°C , $V_{CC} = 2.7V$ to $5.5V$ (unless otherwise noted)

Symbol	Parameter	Condition	Min.	Typ.	Max.	Units
V_{IL}	Input Low Voltage, except XTAL1 and $\overline{\text{RESET}}$ pin	$V_{CC} = 2.7V - 5.5V$	-0.5		$0.3V_{CC}^{(1)}$	V
V_{IH}	Input High Voltage, except XTAL1 and $\overline{\text{RESET}}$ pins	$V_{CC} = 2.7V - 5.5V$	$0.6V_{CC}^{(2)}$		$V_{CC} + 0.5$	V
V_{IL1}	Input Low Voltage, XTAL1 pin	$V_{CC} = 2.7V - 5.5V$	-0.5		$0.1V_{CC}^{(1)}$	V
V_{IH1}	Input High Voltage, XTAL1 pin	$V_{CC} = 2.7V - 5.5V$	$0.7V_{CC}^{(2)}$		$V_{CC} + 0.5$	V
V_{IL2}	Input Low Voltage, $\overline{\text{RESET}}$ pin	$V_{CC} = 2.7V - 5.5V$	-0.5		$0.2V_{CC}^{(1)}$	V
V_{IH2}	Input High Voltage, $\overline{\text{RESET}}$ pin	$V_{CC} = 2.7V - 5.5V$	$0.9V_{CC}^{(2)}$		$V_{CC} + 0.5$	V
V_{IL3}	Input Low Voltage, $\overline{\text{RESET}}$ pin as I/O	$V_{CC} = 2.7V - 5.5V$	-0.5		$0.3V_{CC}^{(1)}$	V
V_{IH3}	Input High Voltage, $\overline{\text{RESET}}$ pin as I/O	$V_{CC} = 2.7V - 5.5V$	$0.6V_{CC}^{(2)}$		$V_{CC} + 0.5$	V
V_{OL}	Output Low Voltage ⁽³⁾ , I/O pin except $\overline{\text{RESET}}$	$I_{OL} = 20\text{mA}$, $V_{CC} = 5V$ $I_{OL} = 5\text{mA}$, $V_{CC} = 3V$			0.8 0.5	V
V_{OH}	Output High Voltage ⁽⁴⁾ , I/O pin except $\overline{\text{RESET}}$	$I_{OH} = -20\text{mA}$, $V_{CC} = 5V$ $I_{OH} = -10\text{mA}$, $V_{CC} = 3V$	4.0 2.2			V
I_{IL}	Input Leakage Current I/O Pin	$V_{CC} = 5.5V$, pin low (absolute value)			1	μA
I_{IH}	Input Leakage Current I/O Pin	$V_{CC} = 5.5V$, pin high (absolute value)			1	μA
R_{RST}	Reset Pull-up Resistor		30		60	$k\Omega$
R_{PU}	I/O Pin Pull-up Resistor		20		50	$k\Omega$

$T_A = -40^{\circ}\text{C}$ to 150°C , $V_{CC} = 2.7\text{V}$ to 5.5V (unless otherwise noted) (Continued)

Symbol	Parameter	Condition	Min.	Typ.	Max.	Units
I_{CC}	Power Supply Current ⁽⁶⁾	Active 4MHz, $V_{CC} = 3\text{V}$ Active 8MHz, $V_{CC} = 5\text{V}$			8 16	mA
$I_{CC\text{ IDLE}}$		Active 16MHz, $V_{CC} = 5\text{V}$			25	mA
		Idle 4MHz, $V_{CC} = 3\text{V}$ Idle 8MHz, $V_{CC} = 5\text{V}$			6 12	mA
		Idle 16MHz, $V_{CC} = 5\text{V}$			14	mA
$I_{CC\text{ PWD}}$	Power-down mode	WDT enabled, $V_{CC} = 3\text{V}$ WDT enabled, $V_{CC} = 5\text{V}$			90 140	μA
		WDT disabled, $V_{CC} = 3\text{V}$ WDT disabled, $V_{CC} = 5\text{V}$			80 120	μA
V_{ACIO}	Analog Comparator Input Offset Voltage	$V_{CC} = 5\text{V}$ $V_{in} = V_{CC}/2$		<10	40	mV
I_{ACLK}	Analog Comparator Input Leakage Current	$V_{CC} = 5\text{V}$ $V_{in} = V_{CC}/2$	-50		50	nA
t_{ACPD}	Analog Comparator Propagation Delay	$V_{CC} = 4.0\text{V}$		500		ns

Maximum Speed vs. V_{CC}

Maximum frequency is dependent on V_{CC} . As shown in Figure 131, the Maximum Frequency vs. V_{CC} curve is linear between $2.7V < V_{CC} < 4.5V$.

Figure 1. Maximum Frequency vs. V_{CC}

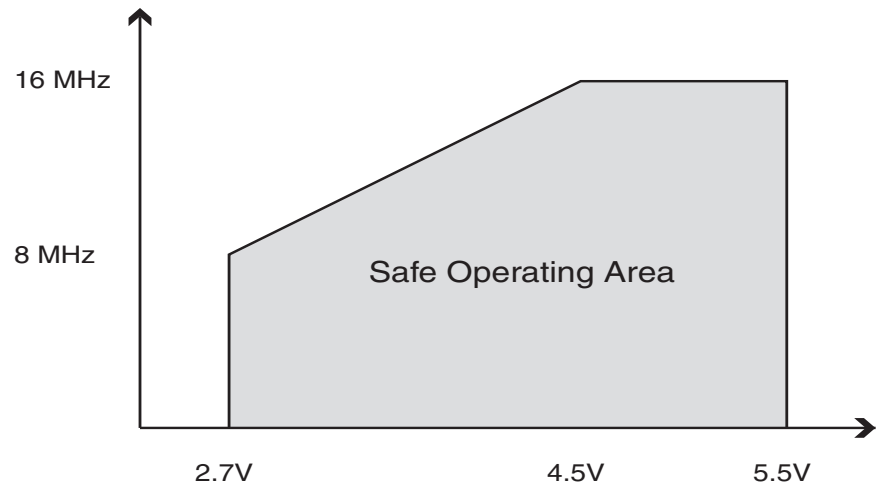

ADC Characteristics⁽⁶⁾

$T_A = -40^{\circ}\text{C}$ to 150°C , $V_{CC} = 4.5\text{V}$ to 5.5V (unless otherwise noted)

Symbol	Parameter	Condition	Min	Typ	Max	Units
	Resolution			10		Bits
	Absolute accuracy (Including INL, DNL, quantization error, gain and offset error)	$V_{REF} = 4\text{V}$, $V_{CC} = 4\text{V}$, ADC clock = 200 kHz		2	3.5	LSB
		$V_{REF} = 4\text{V}$, $V_{CC} = 4\text{V}$, ADC clock = 200 kHz Noise Reduction Mode		2	3.5	LSB
	Integral Non-Linearity (INL)	$V_{REF} = 4\text{V}$, $V_{CC} = 4\text{V}$, ADC clock = 200 kHz		0.6	2.5	LSB
	Differential Non-Linearity (DNL)	$V_{REF} = 4\text{V}$, $V_{CC} = 4\text{V}$, ADC clock = 200 kHz		0.30	1.0	LSB
	Gain Error	$V_{REF} = 4\text{V}$, $V_{CC} = 4\text{V}$, ADC clock = 200 kHz	-3.5	-1.3	3.5	LSB
	Offset Error	$V_{REF} = 4\text{V}$, $V_{CC} = 4\text{V}$, ADC clock = 200 kHz		1.8	3.5	LSB
	Conversion Time	Free Running Conversion	13 cycles			μs
	Clock Frequency		50		200	kHz
AV_{CC}	Analog Supply Voltage		$V_{CC} - 0.3$		$V_{CC} + 0.3$	V
V_{REF}	Reference Voltage		1.0		AV_{CC}	V
V_{IN}	Input Voltage		GND		V_{REF}	V
	Input Bandwidth			38.5		kHz
V_{INT}	Internal Voltage Reference		1.0	1.1	1.2	V
R_{REF}	Reference Input Resistance		25.6	32	38.4	$\text{k}\Omega$
R_{AIN}	Analog Input Resistance			100		$\text{M}\Omega$

- Notes:
- “Max” means the highest value where the pin is guaranteed to be read as low
 - “Min” means the lowest value where the pin is guaranteed to be read as high
 - Although each I/O port can sink more than the test conditions (20mA at $V_{CC} = 5\text{V}$) under steady state conditions (non-transient), the following must be observed:
 - 1] The sum of all IOL, for all ports, should not exceed 400 mA.
 - 2] The sum of all IOL, for ports C0 - C5, should not exceed 200 mA.
 - 3] The sum of all IOL, for ports C6, D0 - D4, should not exceed 300 mA.
 - 4] The sum of all IOL, for ports B0 - B7, D5 - D7, should not exceed 300 mA.
 If IOL exceeds the test condition, VOL may exceed the related specification. Pins are not guaranteed to sink current greater than the listed test condition.
 - Although each I/O port can source more than the test conditions (20mA at $V_{CC} = 5\text{V}$) under steady state conditions (non-transient), the following must be observed:
 - 1] The sum of all IOH, for all ports, should not exceed 400 mA.
 - 2] The sum of all IOH, for ports C0 - C5, should not exceed 200 mA.
 - 3] The sum of all IOH, for ports C6, D0 - D4, should not exceed 300 mA.
 - 4] The sum of all IOH, for ports B0 - B7, D5 - D7, should not exceed 300 mA.

If IOH exceeds the test condition, VOH may exceed the related specification. Pins are not guaranteed to source current greater than the listed test condition.
 5. Minimum V_{CC} for Power-down is 2.5V.

ATmega88 Automotive Typical Characteristics

Active Supply Current

Figure 2. Active Supply Current vs. Frequency (1 - 20 MHz)

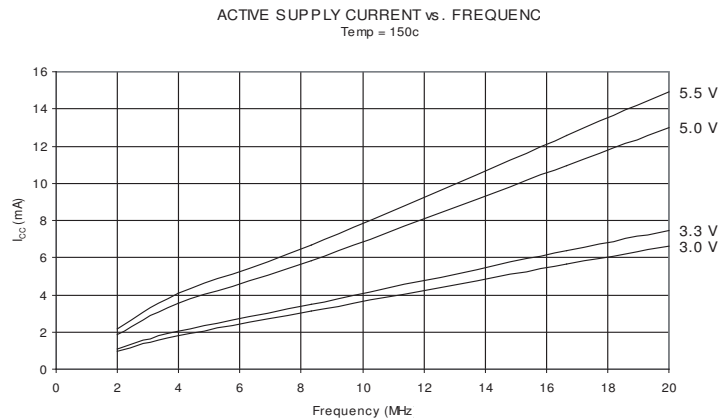
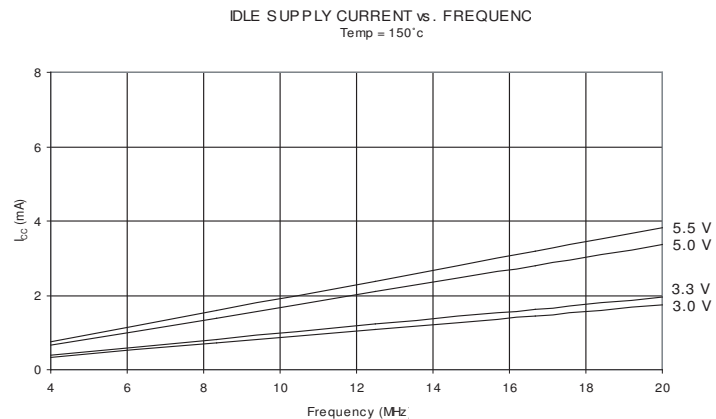

Figure 3. Idle Supply Current vs. Frequency (1 - 20 MHz)



Power-Down Supply Current

Figure 4. Power-Down Supply Current vs. V_{CC} (Watchdog Timer Disabled)

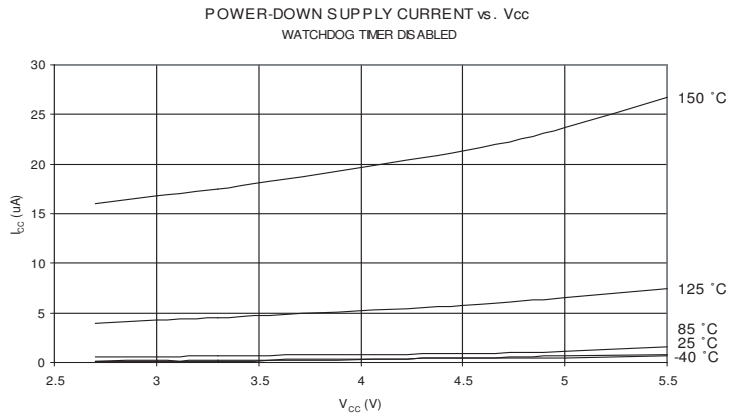
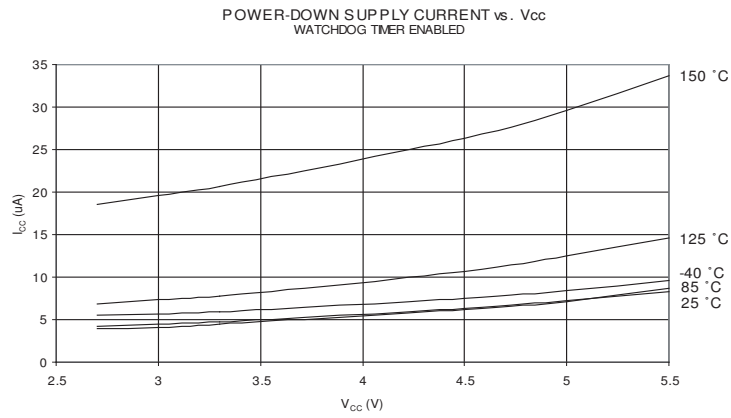

Figure 5. Power-Down Supply Current vs. V_{CC} (Watchdog Timer Enabled)



Pin Pull-up

Figure 6. I/O Pin Pull-up Resistor Current vs. Input Voltage ($V_{CC} = 5V$)

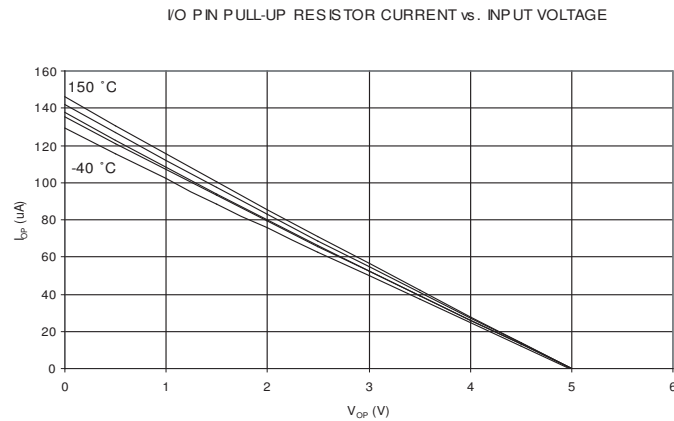

Figure 7. Output Low Voltage vs. Output Low Current ($V_{CC} = 5V$)

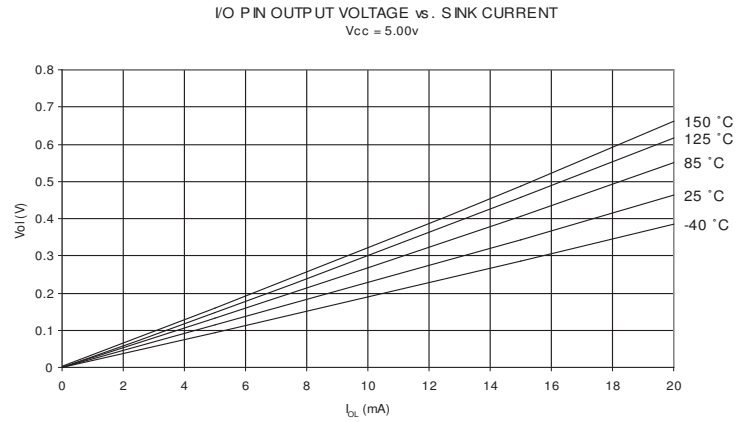

Figure 8. Output Low Voltage vs. Output Low Current ($V_{CC} = 3V$)

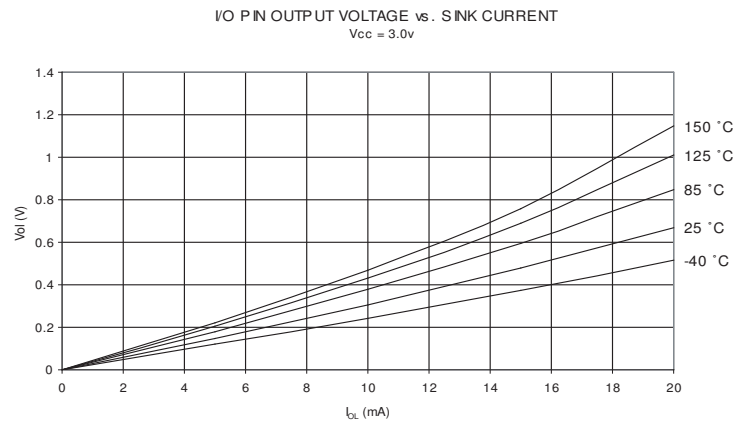

Figure 9. Output High Voltage vs. Output High Current ($V_{CC} = 5V$)

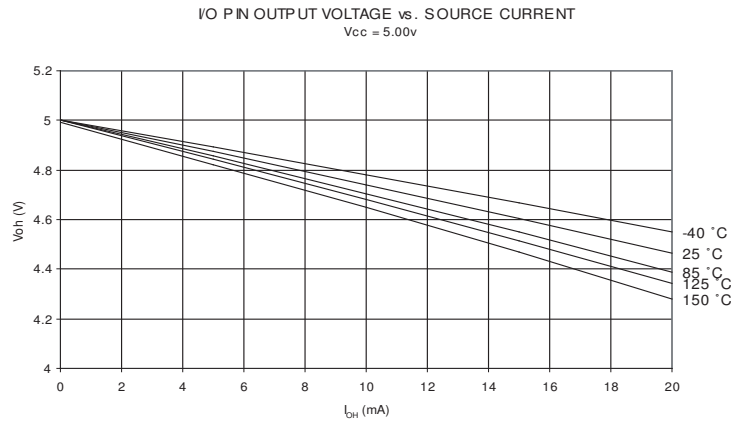

Figure 10. Output High Voltage vs. Output High Current (V_{CC} = 3V)

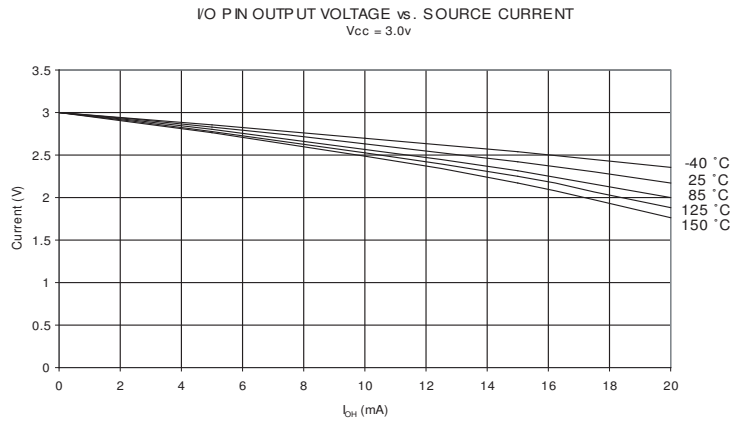
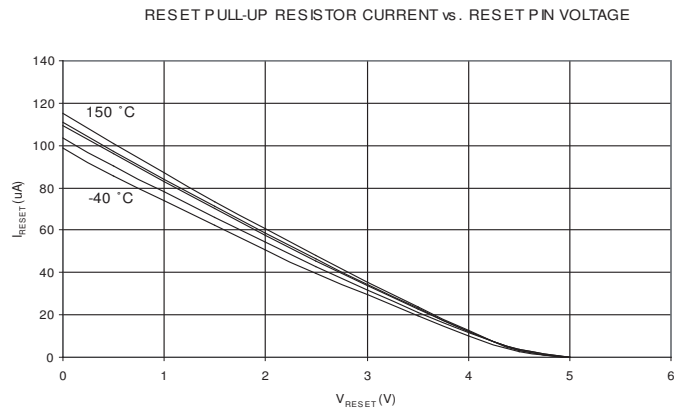

Figure 11. Reset Pull-Up Resistor Current vs. Reset Pin Voltage (V_{CC} = 5V)



Pin Thresholds and Hysteresis

Figure 12. I/O Pin Input Threshold vs. V_{CC} (V_{IH} , I/O Pin Read as '1')

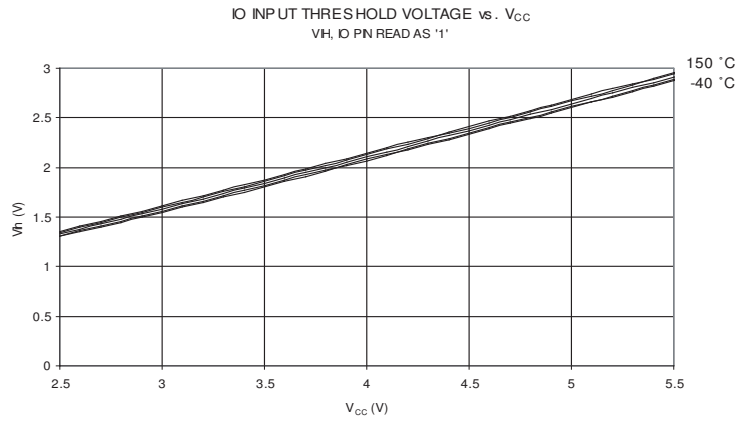

Figure 13. I/O Pin Input Threshold vs. V_{CC} (V_{IL} , I/O Pin Read as '0')

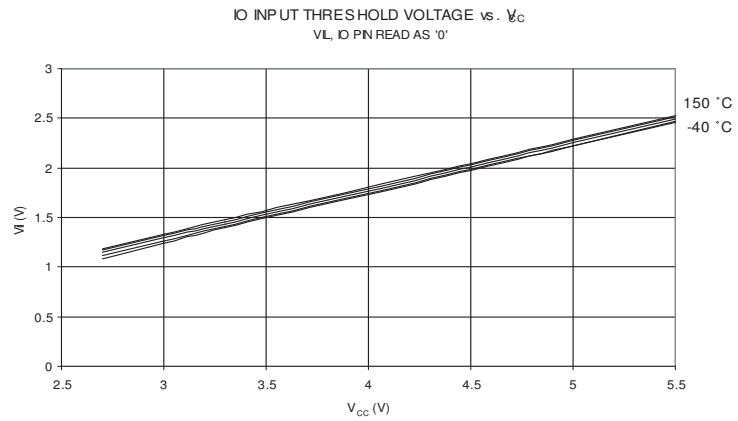

Figure 14. Reset Input Threshold Voltage vs. V_{CC} (V_{IH} , Reset Pin Read as '1')

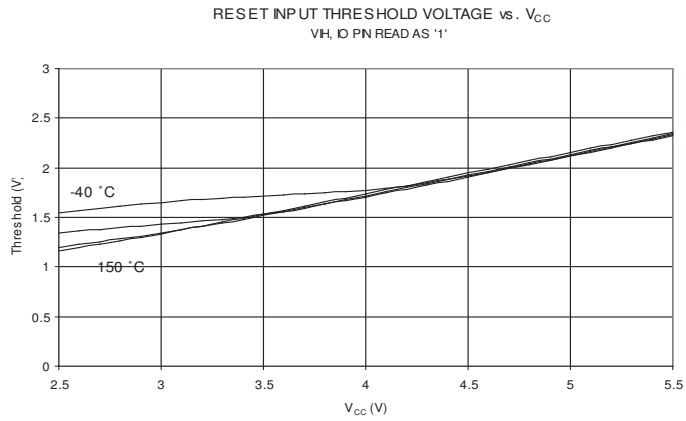
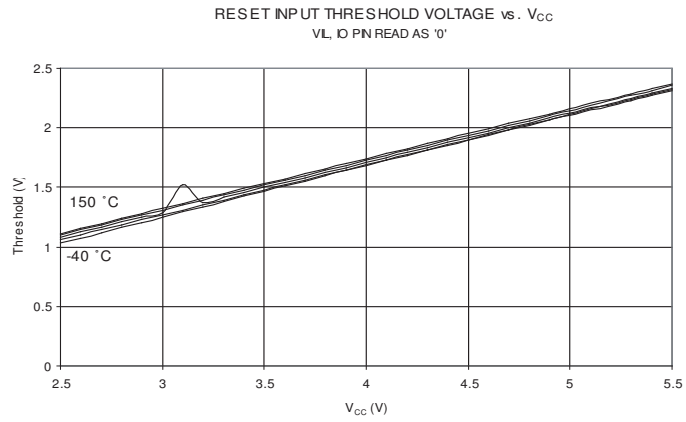

Figure 15. Reset Input Threshold Voltage vs. V_{CC} (VIL, Reset Pin Read as '0')



Internal Oscillator Speed

Figure 16. Watchdog Oscillator Frequency vs. V_{CC}

WATCHDOG OSCILLATOR FREQUENCY vs. TEMPERATURE
V_{CC} from 2.7V to 5.5V

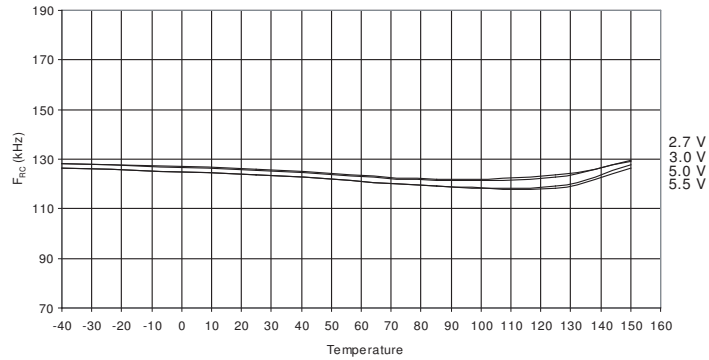

Figure 17. Calibrated 8 MHz RC Oscillator Frequency vs. Temperature

CALIBRATED 8MHz RC OSCILLATOR FREQUENCY vs. TEMPERATURE

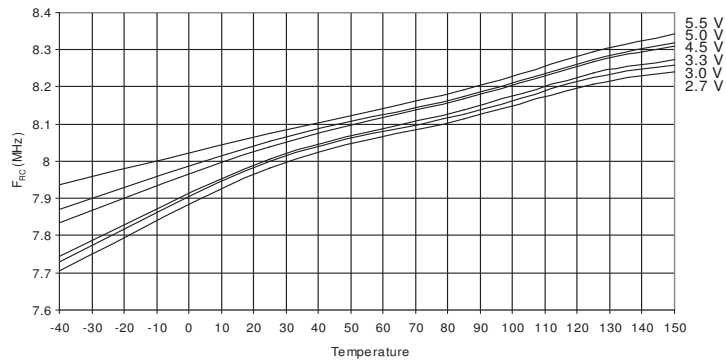

Figure 18. Calibrated 8 MHz RC Oscillator Frequency vs. V_{CC}

CALIBRATED 8MHz RC OSCILLATOR FREQUENCY vs. OPERATING VOLTAGE

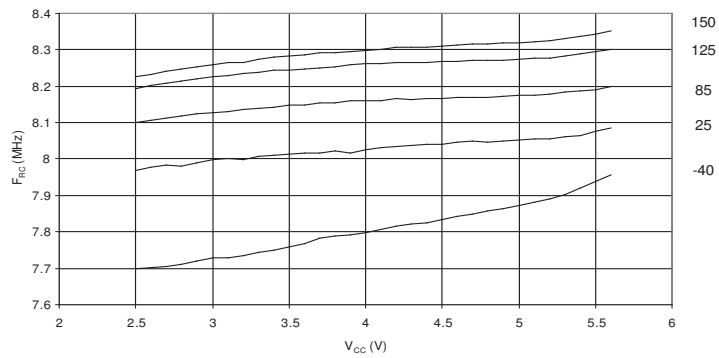
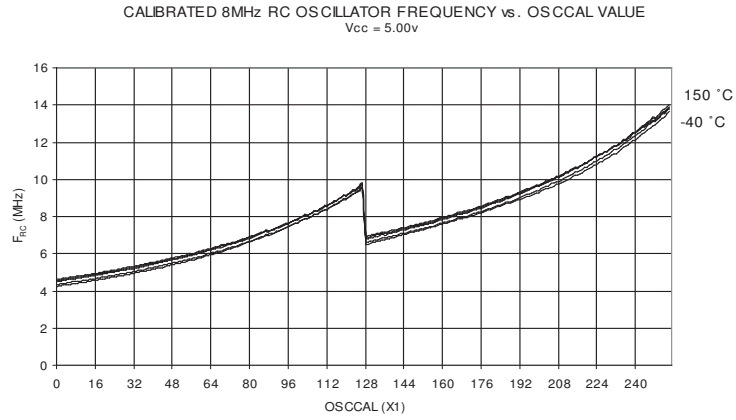

Figure 19. Calibrated 8 MHz RC Oscillator Frequency vs. OSCCAL Value



BOD Thresholds and Analog Comparator Offset

Figure 20. BOD Threshold vs. Temperature (BODLEVEL is 4.0V)

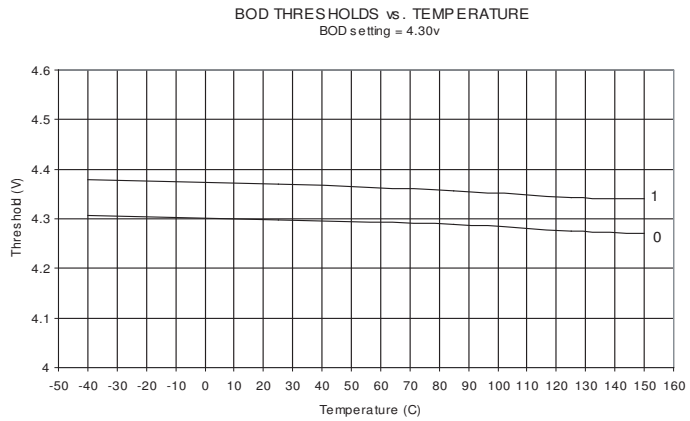

Figure 21. BOD Threshold vs. Temperature (BODLEVEL is 2.7V)

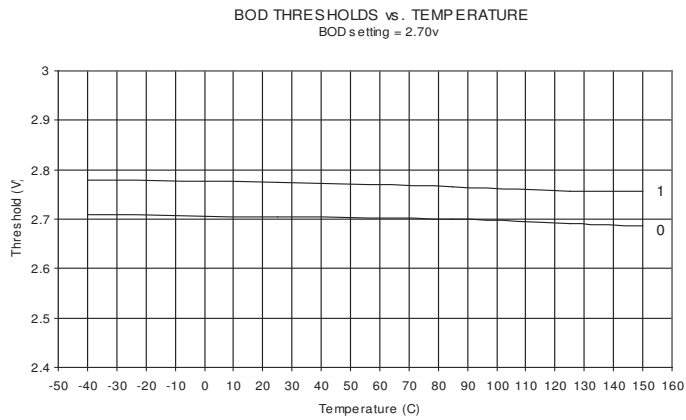
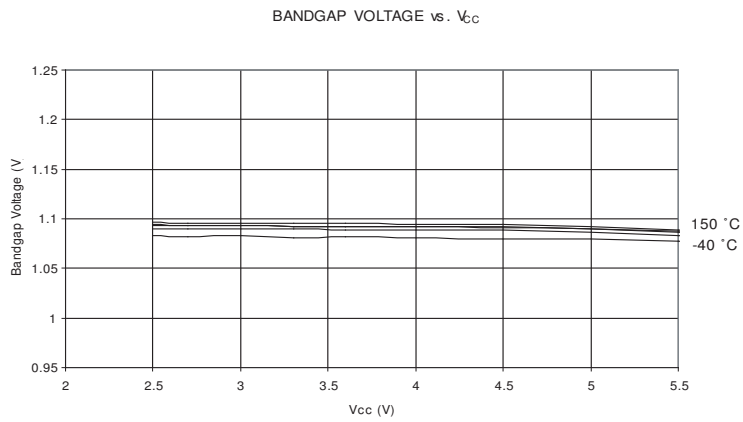

Figure 22. Bandgap Voltage vs. V_{CC}



Peripheral Units

Figure 23. Analog to Digital Converter GAIN vs. V_{CC}

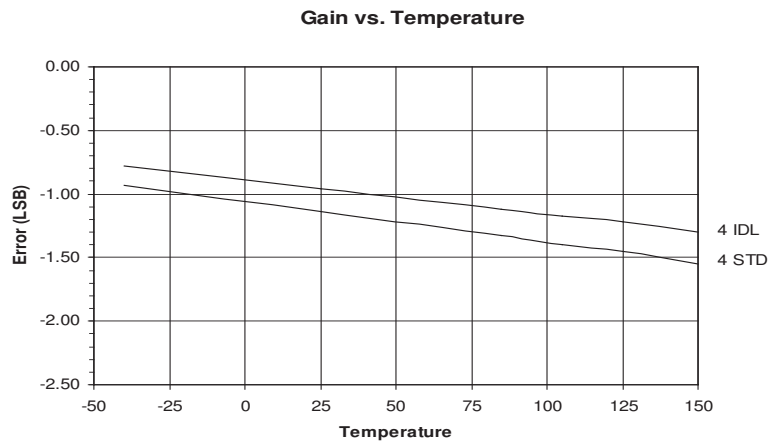

Figure 24. Analog to Digital Converter OFFSET vs. V_{CC}

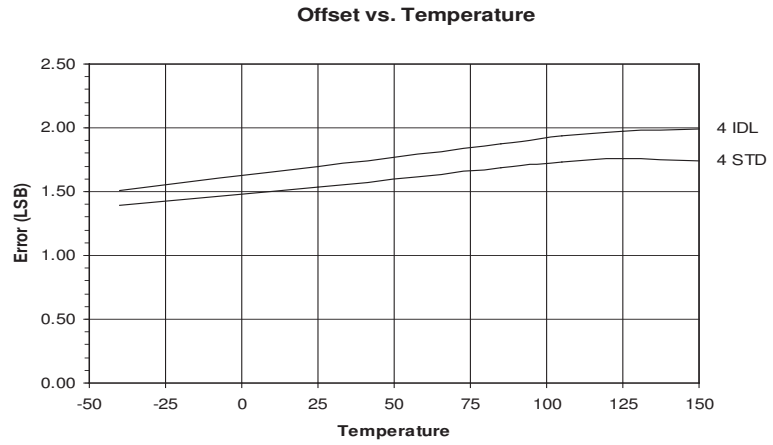

Figure 25. Analog to Digital Converter DNL vs. V_{CC}

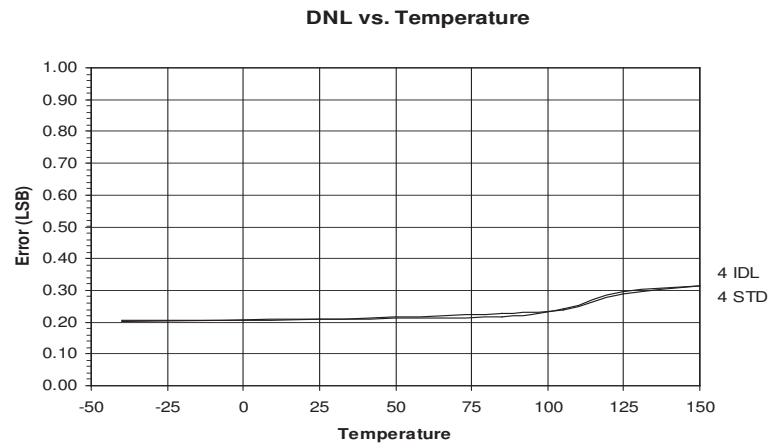
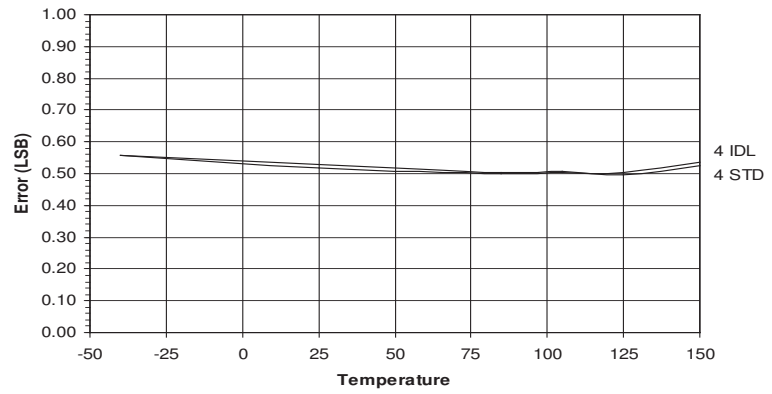

Figure 26. Analog to Digital Converter INL vs. V_{CC}

INL vs. Temperature



Grade 0 Qualification

The ATmega88 has been developed and manufactured according to the most stringent quality assurance requirements of ISO-TS-16949 and verified during product qualification as per AEC-Q100 grade 0.

AEC-Q100 qualification relies on temperature accelerated stress testing. High temperature field usage however may result in less significant stress test acceleration. In order to prevent the risk that ATmega88 lifetime would not satisfy the application end-of-life reliability requirements, Atmel has extended the testing, whenever applicable (High Temperature Operating Life Test, High Temperature Storage Life, Data Retention, Thermal Cycles), far beyond the AEC-Q100 requirements. Thereby, Atmel verified the ATmega88 has a long safe lifetime period after the grade 0 qualification acceptance limits.

The valid domain calculation depends on the activation energy of the potential failure mechanism that is considered. Examples are given in figure 1. Therefore any temperature mission profile which could exceed the AEC-Q100 equivalence domain shall be submitted to Atmel for a thorough reliability analysis

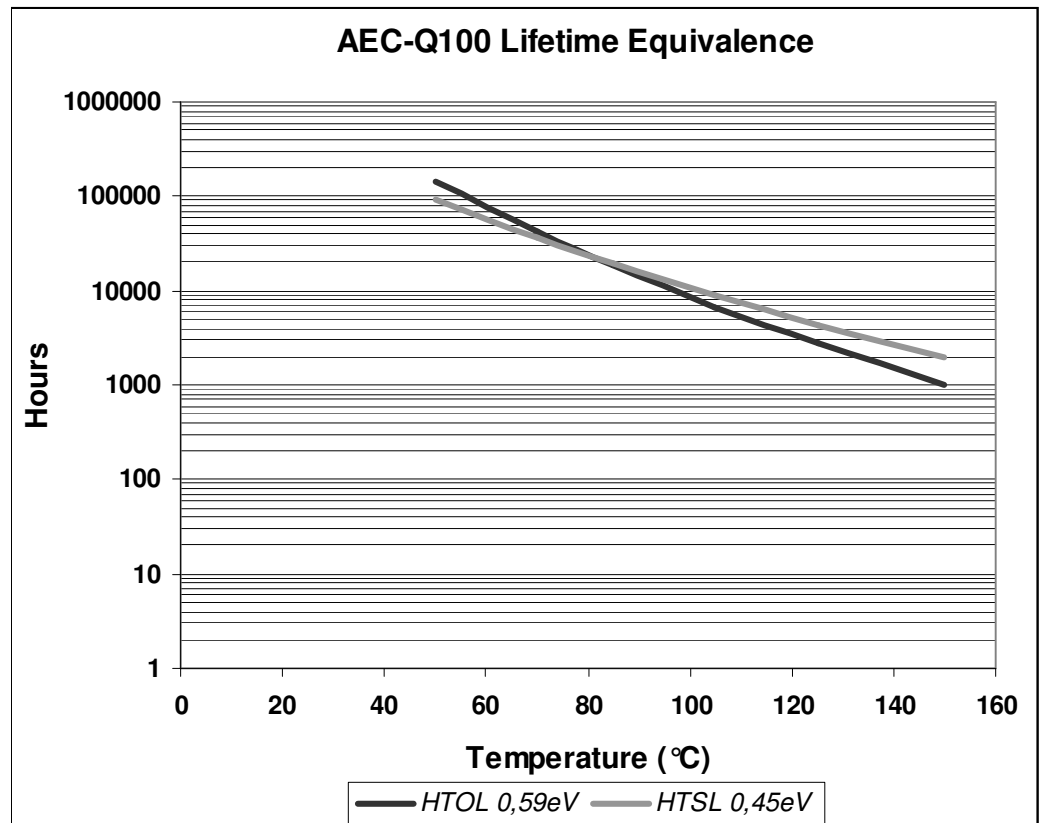



Ordering Information

ATmega88 Automotive

Speed (MHz)	Power Supply	Ordering Code	Package ⁽¹⁾	Operation Range
16 ⁽²⁾	2.7 - 5.5V	ATmega88-15MT2	PN	Extended (-40°C to 150°C)

Notes: 1. Pb-free packaging, complies to the European Directive for Restriction of Hazardous Substances (RoHS directive). Also Halide free and fully Green.
2. For Speed vs. V_{CC} , see complete datasheet.

Package Type	
PN	32-pad, 5 x 5 x 1.0 mm body, lead pitch 0.50 mm, Quad Flat No-Lead/Micro Lead Frame Package (QFN/MLF): E2/D2 3.1 +/- 0.1mm

PN

32 LEADS Quad Flat No lead

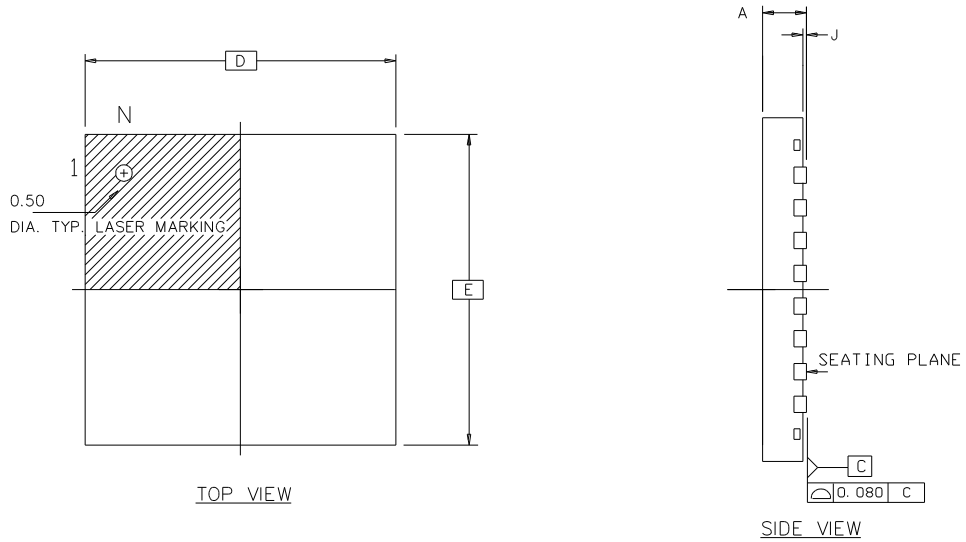

DRAWINGS NOT SCALED

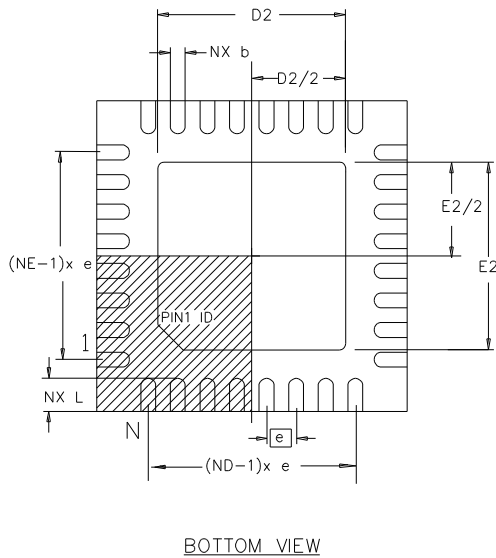

	MM			INCH		
	MIN	NDM	MAX	MIN	NDM	MAX
A	0.80	-	1.00	.032	-	.040
J	0.00		0.05	.000		.002
D/E	5.00 +/-	0.10		.197 +/-		.004
D2/E2	*	*	*	-	-	-
N	32					
ND	8					
NE	8					
e	0.50 BSC			.020 BSC		
L	0.30	0.40	0.50	.012	.016	.020
b	0.18	0.25	0.30	.007	.010	.012

*See Package Information

Compliant JEDEC Standard MO-220 variation VHHD-2



Atmel Corporation

2325 Orchard Parkway
San Jose, CA 95131, USA
Tel: 1(408) 441-0311
Fax: 1(408) 487-2600

Regional Headquarters

Europe

Atmel Sarl
Route des Arsenalux 41
Case Postale 80
CH-1705 Fribourg
Switzerland
Tel: (41) 26-426-5555
Fax: (41) 26-426-5500

Asia

Room 1219
Chinachem Golden Plaza
77 Mody Road Tsimshatsui
East Kowloon
Hong Kong
Tel: (852) 2721-9778
Fax: (852) 2722-1369

Japan

9F, Tonetsu Shinkawa Bldg.
1-24-8 Shinkawa
Chuo-ku, Tokyo 104-0033
Japan
Tel: (81) 3-3523-3551
Fax: (81) 3-3523-7581

Atmel Operations

Memory

2325 Orchard Parkway
San Jose, CA 95131, USA
Tel: 1(408) 441-0311
Fax: 1(408) 436-4314

Microcontrollers

2325 Orchard Parkway
San Jose, CA 95131, USA
Tel: 1(408) 441-0311
Fax: 1(408) 436-4314

La Chantrerie
BP 70602
44306 Nantes Cedex 3, France
Tel: (33) 2-40-18-18-18
Fax: (33) 2-40-18-19-60

ASIC/ASSP/Smart Cards

Zone Industrielle
13106 Rousset Cedex, France
Tel: (33) 4-42-53-60-00
Fax: (33) 4-42-53-60-01

1150 East Cheyenne Mtn. Blvd.
Colorado Springs, CO 80906, USA
Tel: 1(719) 576-3300
Fax: 1(719) 540-1759

Scottish Enterprise Technology Park
Maxwell Building
East Kilbride G75 0QR, Scotland
Tel: (44) 1355-803-000
Fax: (44) 1355-242-743

RF/Automotive

Theresienstrasse 2
Postfach 3535
74025 Heilbronn, Germany
Tel: (49) 71-31-67-0
Fax: (49) 71-31-67-2340

1150 East Cheyenne Mtn. Blvd.
Colorado Springs, CO 80906, USA
Tel: 1(719) 576-3300
Fax: 1(719) 540-1759

Biometrics/Imaging/Hi-Rel MPU/ High Speed Converters/RF Datacom

Avenue de Rochepleine
BP 123
38521 Saint-Egreve Cedex, France
Tel: (33) 4-76-58-30-00
Fax: (33) 4-76-58-34-80

Literature Requests

www.atmel.com/literature

Disclaimer: The information in this document is provided in connection with Atmel products. No license, express or implied, by estoppel or otherwise, to any intellectual property right is granted by this document or in connection with the sale of Atmel products. **EXCEPT AS SET FORTH IN ATMEL'S TERMS AND CONDITIONS OF SALE LOCATED ON ATMEL'S WEB SITE, ATMEL ASSUMES NO LIABILITY WHATSOEVER AND DISCLAIMS ANY EXPRESS, IMPLIED OR STATUTORY WARRANTY RELATING TO ITS PRODUCTS INCLUDING, BUT NOT LIMITED TO, THE IMPLIED WARRANTY OF MERCHANTABILITY, FITNESS FOR A PARTICULAR PURPOSE, OR NON-INFRINGEMENT. IN NO EVENT SHALL ATMEL BE LIABLE FOR ANY DIRECT, INDIRECT, CONSEQUENTIAL, PUNITIVE, SPECIAL OR INCIDENTAL DAMAGES (INCLUDING, WITHOUT LIMITATION, DAMAGES FOR LOSS OF PROFITS, BUSINESS INTERRUPTION, OR LOSS OF INFORMATION) ARISING OUT OF THE USE OR INABILITY TO USE THIS DOCUMENT, EVEN IF ATMEL HAS BEEN ADVISED OF THE POSSIBILITY OF SUCH DAMAGES.** Atmel makes no representations or warranties with respect to the accuracy or completeness of the contents of this document and reserves the right to make changes to specifications and product descriptions at any time without notice. Atmel does not make any commitment to update the information contained herein. Unless specifically provided otherwise, Atmel products are not suitable for, and shall not be used in, automotive applications. Atmel's products are not intended, authorized, or warranted for use as components in applications intended to support or sustain life.

©2007 Atmel Corporation. All rights reserved. Atmel®, logo and combinations thereof, Everywhere You Are®, AVR®, and AVR Studio® are registered trademarks of Atmel Corporation or its subsidiaries. Other terms and product names may be trademarks of others.



Printed on recycled paper.

7607D-AVR-03/07