

8mm Round With Flange Type  
White LED  
Technical Data Sheet

Part No.: LL-804WC2C-W2-3SD

## Features:

- ◇ 8 mm Round.
- ◇ Viewing angle=30°.
- ◇ Available on tape and reel
- ◇ Emission color: X=0.28, y=0.29.
- ◇ Reliable and robust
- ◇ The product itself will remain within RoHS compliant Version.

## Descriptions:

- ◇ The series is specially designed for applications requiring higher brightness.
- ◇ The LED lamps are available with different colors, intensities.
- ◇ The white LED which was fabricated using a blue LED and a phosphor, and the phosphor is excited by blue light and emits yellow fluorescence. The mixture of blue light and yellow light results in white emission.
- ◇ Utilizing advanced InGaN chip technology.

## Applications:

- ◇ QA equipment.
- ◇ Backlighting of LCD.
- ◇ Automotive equipment.
- ◇ Replacement of conventional Light bulbs and fluorescent lamps.
- ◇ Indoor and out door displays, etc.

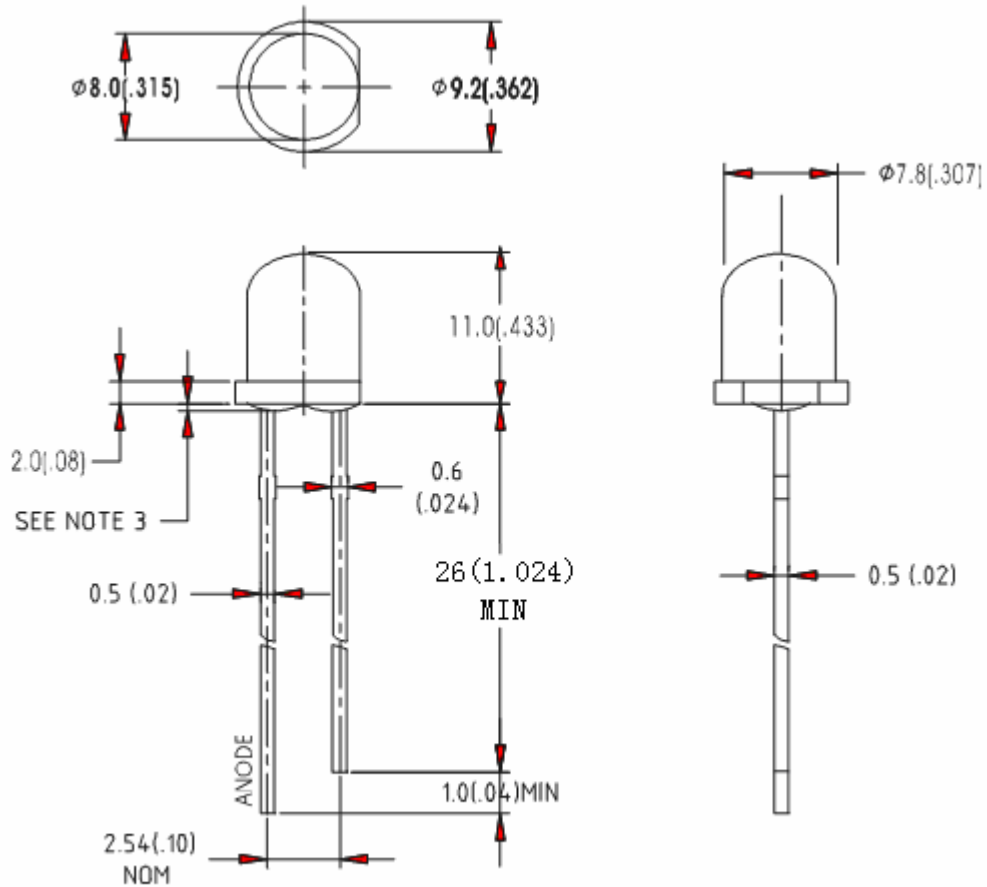
**Package Dimension:**

Part No.	Chip Material	Lens Color	Source Color
LL-804WC2C-W2-3SD	InGaN	Water Clear	White

**Notes:**

1. All dimensions are in millimeters (inches).
2. Tolerance is  $\pm 0.25$  mm (.010") unless otherwise noted.
3. Protruded resin under flange is 1.00 mm (.039") max.

**Absolute Maximum Ratings at Ta=25°C**

Parameters	Symbol	Max.	Unit
Power Dissipation	<b><i>PD</i></b>	100	mW
Peak Forward Current (1/10 Duty Cycle, 0.1ms Pulse Width)	<b><i>IFP</i></b>	100	mA
Forward Current	<b><i>IF</i></b>	25	mA
Reverse Voltage	<b><i>VR</i></b>	5	V
Operating Temperature Range	<b><i>Topr</i></b>	-40°C to +85°C	
Storage Temperature Range	<b><i>Tstg</i></b>	-40°C to +100°C	
Lead Soldering Temperature [4mm (.157") From Body]	<b><i>Tsld</i></b>	260°C for 5 Seconds	

**Notes:**

1. Proper current derating must be observed to maintain junction temperature below the maximum.
2. LEDs are not designed to be driven in reserve bias.

**Electrical Optical Characteristics at Ta=25°C**

Parameters	Symbol	Min.	Typ.	Max.	Unit	Test Condition
Viewing Angle	<b><i>2θ<sub>1/2</sub></i></b>	---	30	---	Deg	IF = 20mA
Forward Voltage	<b><i>V<sub>F</sub></i></b>	2.8	3.3	3.8	V	IF = 20mA
Reverse Current	<b><i>I<sub>R</sub></i></b>	---	---	10	μA	V <sub>R</sub> =5V
Chromaticity Coordinates	<b><i>x</i></b>	---	0.28	---	---	IF = 20mA
	<b><i>y</i></b>	---	0.29	---	---	
Luminous Intensity	<b><i>I<sub>v</sub></i></b>	8500	13500	---	mcd	IF = 20mA

**Notes:**

1. Luminous Intensity Measurement allowance is ± 10%.
2. θ<sub>1/2</sub> is the off-axis angle at which the luminous intensity is half the axial luminous intensity.

### CIE 1931 Chromaticity Diagram

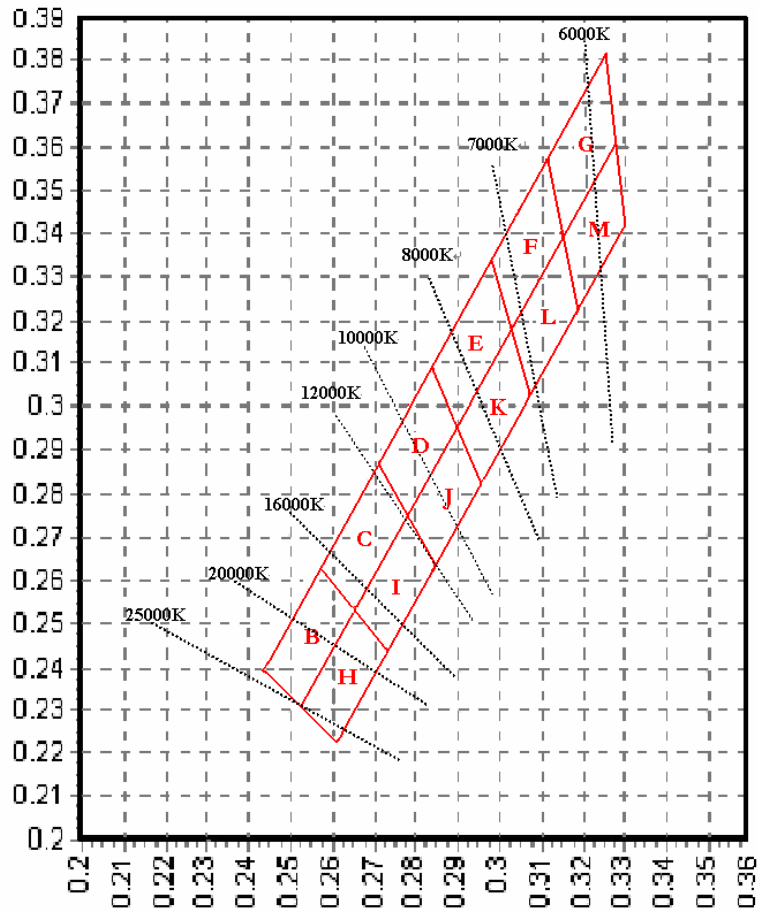

IF=20mA.Ta=25°C

Bin code	x	y	Color(K)	Bin code	x	y	Color(K)
B	0.255	0.247	20000	H	0.263	0.237	20000
C	0.268	0.270	16000	I	0.275	0.259	16000
D	0.281	0.293	10000	J	0.288	0.279	10000
E	0.294	0.315	8000	K	0.299	0.300	8000
F	0.307	0.339	7000	L	0.311	0.321	7000
G	0.320	0.361	6000	M	0.323	0.341	6000

Measurement uncertainty of the color coordinates :  $\pm 0.01$ .

## Reliability Test Items And Conditions:

The reliability of products shall be satisfied with items listed below:

Confidence level: 90%.

LTPD: 10%.

### 1) Test Items and Results:

Test Item	Standard Test Method	Test Conditions	Note	Number of Damage d
Resistance to Soldering Heat	JEITA ED-4701 300 302	Tsld=260±5°C, 10sec 4mm from the base of the epoxy bulb	1 time	0/100
Solder ability	JEITA ED-4701 300 303	Tsld=235±5°C, 5sec(using flux)	1time over 95%	0/100
Thermal Shock	JEITA ED-4701 300 307	0°C~100°C 15sec, 15sec	100 cycles	0/100
Temperature Cycle	JEITA ED-4701 100 105	-40°C~25°C~100°C~25°C 30min,5min,30min,5min	100 cycles	0/100
Moisture Resistance Cycle	JEITA ED-4701 200 203	25°C~65°C~-10°C 90%RH 24hrs/1cycle	10 cycles	0/100
High Temperature Storage	JEITA ED-4701 200 201	Ta=100°C	1000hrs	0/100
Terminal Strength (Pull test)	JEITA ED-4701 400 401	Load 10N (1kgf) 10±1sec	No noticeable damage	0/100
Terminal Strength (bending test)	JEITA ED-4701 400 401	Load 5N (0.5kgf) 0°~90°~0° bend 2 times	No noticeable damage	0/100
Temperature Humidity Storage	JEITA ED-4701 100 103	Ta=60°C, RH=90%	1000hrs	0/100
Low Temperature Storage	JEITA ED-4701 200 202	Ta=-40°C	1000hrs	0/100
Steady State Operating Life		Ta=25°C, IF=30mA	1000hrs	0/100
Steady State Operating Life of High Humidity Heat		Ta=60°C, RH=90%, IF=30mA	500hrs	0/100
Steady State Operating Life of Low Temperature		Ta=-30°C, IF=20mA	1000hrs	0/100

### 2) Criteria For Judging The Damage:

Item	Symbol	Test Conditions	Criteria for Judgment	
			Min	Max
Forward Voltage	VF	IF=20mA	---	F.V.*)×1.1
Reverse Current	IR	VR=5V	---	F.V.*)×2.0
Luminous Intensity	IV	IF=20mA	F.V.*)×0.7	---

\*) F.V.: First Value.

### Typical Electrical / Optical Characteristics Curves (25°C Ambient Temperature Unless Otherwise Noted)

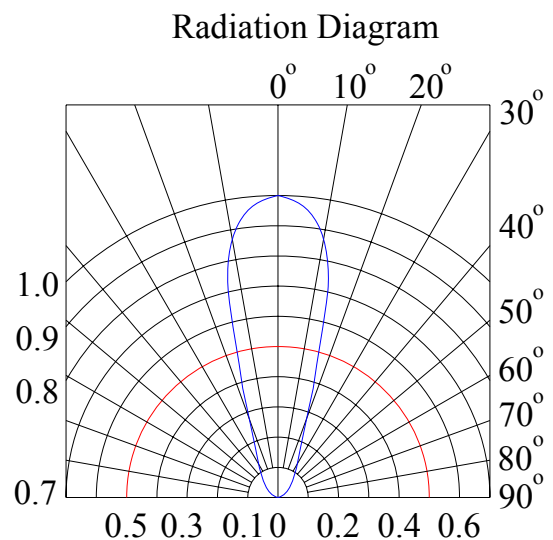
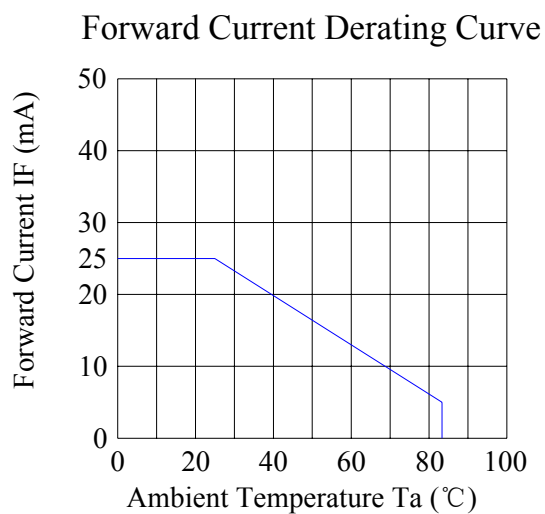
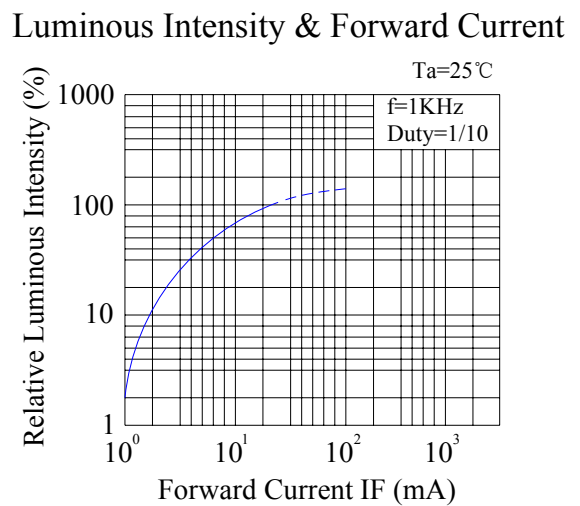
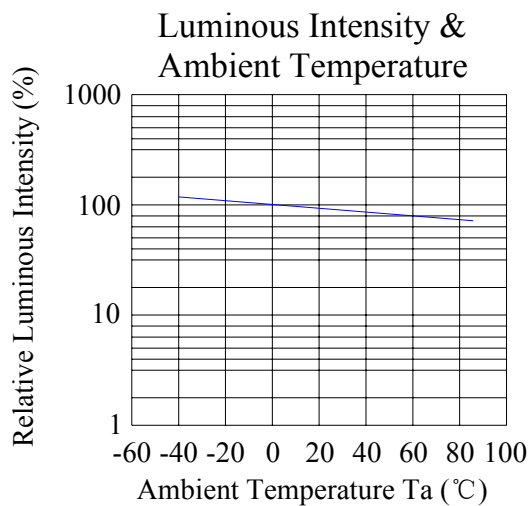
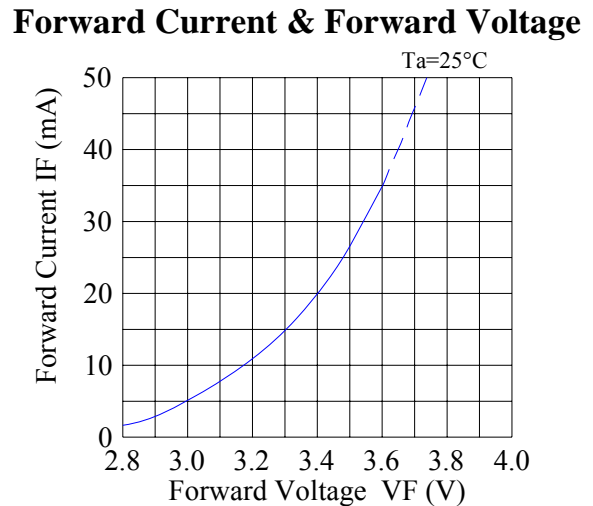
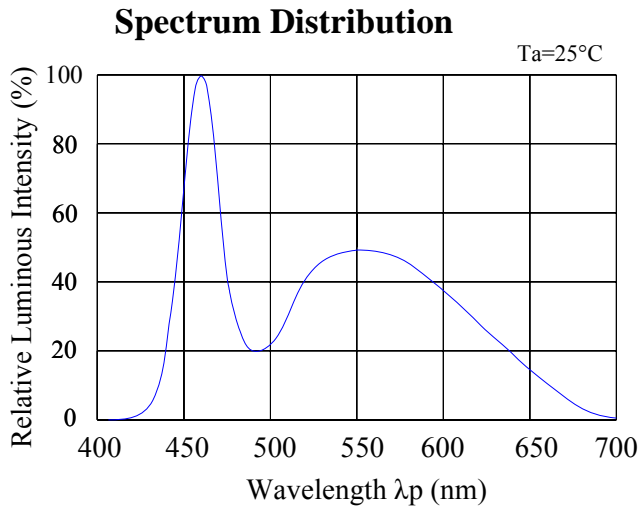

## **Please read the following notes before using the datasheets:**

### **1. Over-current-proof**

Customer must apply resistors for protection, otherwise slight voltage shift will cause big current change (Burn out will happen).

### **2. Storage**

2.1 Do not open moisture proof bag before the products are ready to use.

2.2 Before opening the package, the LEDs should be kept at 30°C or less and 90%RH or less.

2.3 The LEDs should be used within a year.

2.4 After opening the package, the LEDs should be kept at 30°C or less and 70%RH or less.

2.5 The LEDs should be used within 168 hours (7 days) after opening the package.

### **3. Soldering Condition**

3.1 Pb-free solder temperature profile.

3.2 Reflow soldering should not be done more than two times.

3.3 When soldering, do not put stress on the LEDs during heating.

3.4 After soldering, do not warp the circuit board.

### **4. Soldering Iron**

Each terminal is to go to the tip of soldering iron temperature less than 260°C for 5 seconds within once in less than the soldering iron capacity 25W. Leave two seconds and more intervals, and do soldering of each terminal. Be careful because the damage of the product is often started at the time of the hand solder.

### **5. Repairing**

Repair should not be done after the LEDs have been soldered. When repairing is unavoidable, a double-head soldering iron should be used (as below figure). It should be confirmed beforehand whether the characteristics of the LEDs will or will not be damaged by repairing.

### **6. Caution in ESD**

Static Electricity and surge damages the LED. It is recommend to use a wrist band or anti-electrostatic glove when handling the LED. All devices equipment and machinery must be properly grounded.