

Connector - SACC-M12FS-5CON-PG11-DUO - 1694596

Please be informed that the data shown in this PDF Document is generated from our Online Catalog. Please find the complete data in the user's documentation. Our General Terms of Use for Downloads are valid (<http://phoenixcontact.com/download>)



Connector, Universal, 5-position, Socket straight M12, Coding: A, Screw connection, knurl material: Plastic, cable gland Pg11-DUO, external cable diameter 2.1 mm ... 3 mm / 4 mm ... 5.2 mm

Your advantages

- ✓ Safe use in the field, thanks to a high degree of protection
- ✓ Screw connection: proven connection technology for a large selection of different conductors
- ✓ Save space: connect two sensors to one connector with a multiple grommet



Key Commercial Data

Packing unit	1 pc
GTIN	 4 017918 457099
GTIN	4017918457099
Sales Key	02

Technical data

Dimensions

Diameter housing	20 mm
Length	58 mm
External cable diameter	2x 2.1 mm ... 3 mm (when using the seal for small outer cable diameters)
	2x 4 mm ... 5.2 mm (when using the seal for large outer cable diameters)
Stripping length of the sheath	20 mm
Stripping length of the individual wire	5 mm

Ambient conditions

Ambient temperature (operation)	-40 °C ... 85 °C (Plug / socket)
	-40 °C ... 85 °C (Plug / socket)
Degree of protection	IP67

Connector - SACC-M12FS-5CON-PG11-DUO - 1694596

Technical data

General

Note	NOTE: Observe the permissible bending radii when laying conductors, since the degree of protection may be put in jeopardy if the bending forces are too high. Alleviate mechanical loads upstream of the connector, e.g. by using cable ties.
Rated current at 40°C	4 A
Rated voltage	48 V AC 60 V DC
Number of positions	5
Color handle area	black
Insulation resistance	≥ 100 MΩ
Coding	A - standard
Standards/regulations	M12 connector IEC 61076-2-101
Signal type/category	Universal
Status display	No
Overvoltage category	II
Degree of pollution	3
Connection method	Screw connection
Conductor cross section	0.25 mm² ... 0.75 mm² (without ferrule) 0.14 mm² ... 0.75 mm² (with ferrule) 0.25 mm² ... 0.75 mm² (solid)
Conductor cross section AWG	24 ... 18 (without ferrule) 26 ... 20 (with ferrule)
Insertion/withdrawal cycles	≥ 50
Torque	0.4 Nm (M12 knurl) 0.8 Nm ... 1 Nm 0.2 Nm (Screw terminal blocks)
Tightening torque	Screw plug insert with sleeve housing as far it will go
Assembly instructions	This connector includes one seal for small and one seal for large outer cable diameters.

Material

Contact material	CuZn
Contact surface material	CuSnZn
Contact carrier material	PA
Material of grip body	PA
Material, knurls	Plastic
Sealing material	NBR

Standards and Regulations

Standards/specifications	M12 connector IEC 61076-2-101
Connection in acc. with standard	CUL
Standards/specifications	M12 connector IEC 61076-2-101

Environmental Product Compliance

Connector - SACC-M12FS-5CON-PG11-DUO - 1694596

Technical data

Environmental Product Compliance

REACH SVHC	Lead 7439-92-1
China RoHS	Environmentally Friendly Use Period = 50 years
	For details about hazardous substances go to tab "Downloads", Category "Manufacturer's declaration"

Drawings

Schematic diagram

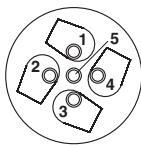

Cable connection side M12 (screw connection)

Dimensional drawing

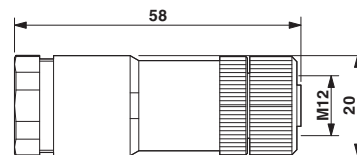

M12 x 1 socket, straight

Schematic diagram

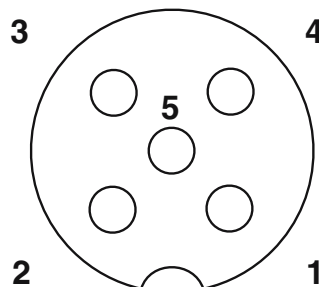

Pin assignment M12 socket, 5-pos., A-coded, socket side view

Connector - SACC-M12FS-5CON-PG11-DUO - 1694596

Dimensional drawing

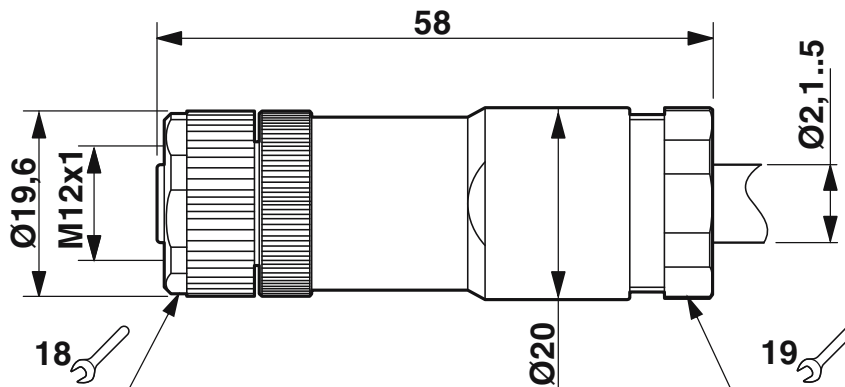

M12 x 1 socket, straight

Classifications

eCl@ss

eCl@ss 10.0.1	27440102
eCl@ss 11.0	27440102
eCl@ss 4.0	27260700
eCl@ss 4.1	27260700
eCl@ss 5.0	27260700
eCl@ss 5.1	27260700
eCl@ss 6.0	27279200
eCl@ss 7.0	27440104
eCl@ss 9.0	27440102

ETIM

ETIM 2.0	EC001121
ETIM 3.0	EC002062
ETIM 4.0	EC002062
ETIM 6.0	EC002062
ETIM 7.0	EC002635

UNSPSC

UNSPSC 6.01	31251501
UNSPSC 7.0901	31251501
UNSPSC 11	31251501
UNSPSC 12.01	31251501
UNSPSC 13.2	39121413
UNSPSC 18.0	39121413
UNSPSC 19.0	39121413

Connector - SACC-M12FS-5CON-PG11-DUO - 1694596

Classifications

UNSPSC

UNSPSC 20.0	39121413
UNSPSC 21.0	39121413

Approvals

Approvals

Approvals

UL Recognized / cUL Recognized / cULus Recognized

Ex Approvals

Approval details

UL Recognized		http://database.ul.com/cgi-bin/XYV/template/LISEXT/1FRAME/index.htm	FILE E 221474
Nominal voltage UN	125 V		
Nominal current IN	4 A		

cUL Recognized		http://database.ul.com/cgi-bin/XYV/template/LISEXT/1FRAME/index.htm	FILE E 221474
Nominal voltage UN	125 V		
Nominal current IN	4 A		

cULus Recognized	
------------------	---

Accessories

Accessories

Cable by the meter

Connector - SACC-M12FS-5CON-PG11-DUO - 1694596

Accessories

Cable reel - SAC-3P-100,0-PUR/0,25 - 1501689



By the meter, Cable reel, PUR halogen-free, black-gray RAL 7021, 3-wire, color single wire: brown, blue, black, cable length: 100 m

Cable reel - SAC-3P-100,0-PUR/0,34 - 1501650



By the meter, Cable reel, PUR halogen-free, black-gray RAL 7021, 3-wire, color single wire: brown, blue, black, cable length: 100 m

Cable reel - SAC-4P-100,0-PUR/0,25 - 1501692



By the meter, Cable reel, PUR halogen-free, black-gray RAL 7021, 4-wire, color single wire: brown, white, blue, black, cable length: 100 m

Cable reel - SAC-4P-100,0-PUR/0,34 - 1501663



By the meter, Cable reel, PUR halogen-free, black-gray RAL 7021, 4-wire, color single wire: brown, white, blue, black, cable length: 100 m

Cable reel - SAC-5P-100,0-PUR/0,34 - 1501676



By the meter, Cable reel, PUR halogen-free, black-gray RAL 7021, 5-wire, color single wire: brown, white, blue, black, green-yellow, cable length: 100 m

Plug for cable screw gland

Connector - SACC-M12FS-5CON-PG11-DUO - 1694596

Accessories

Screw plug - PROT-M12 MS-PA-CHAIN - 1430899

M12 sealing cap with fixing band, for sensor cables, for free M12 sockets



Screwdriver tools

Adapter insert - TSD-M SAC-BIT ADAPTER - 1212600



Adapter bit for TSD-M...torque tools, E6.3-1/4" drive with 4 mm hexagon to accommodate SAC bits

Tool - SACC BIT M12-D20 - 1208445



Nut for assembling M12 connectors for assembly with a knurl diameter of 20 mm, for 4 mm hexagonal drive

Screwdriver - SZF 1-0,6X3,5 - 1204517



Actuation tool, for ST terminal blocks, also suitable for use as a bladed screwdriver, size: 0.6 x 3.5 x 100 mm, 2-component grip, with non-slip grip

Torque tool

Torque screwdriver - TSD 04 SAC - 1208429



Torque screwdriver, with preset torque of 0.4 Nm and 4 mm hexagonal drive for M12 connectors

Connector - SACC-M12FS-5CON-PG11-DUO - 1694596

Accessories

Torque screwdriver - TSD-M 1,2NM - 1212224



Torque screw driver, accuracy as per EN ISO 6789 standard, adjustable from 0.3 - 1.2 Nm

Phoenix Contact 2021 © - all rights reserved
<http://www.phoenixcontact.com>

PHOENIX CONTACT GmbH & Co. KG
Flachsmarktstr. 8
32825 Blomberg
Germany
Tel. +49 5235 300
Fax +49 5235 3 41200
<http://www.phoenixcontact.com>