

572-4876 Insulated solder terminal, Turreted

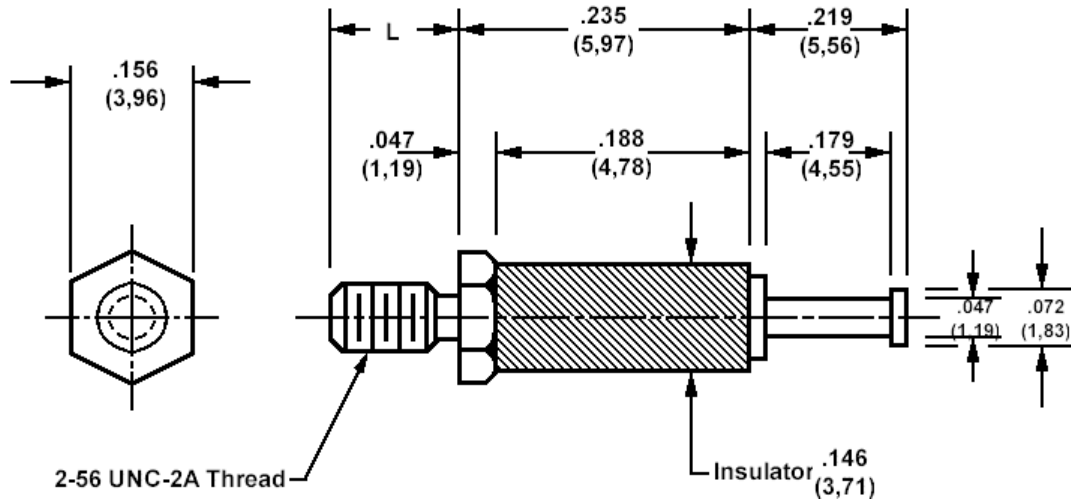

How to order code

572-4876-XX-YY-16

Basic Part No (XX = thread length, YY = plating finish. See tables for options)

Basic Part No.	XX	L
572-4876	-01	.125 (3,18)
	-02	.188 (4,78)
	-03	.250 (6,35)

Component	Material	Finish (YY)	
		-01	-05
Terminal	Brass	Silver	Electro Solder
Stud	Brass	Cadmium (plus chromate)	Cadmium (plus chromate)
Insulator	Diallyl Phthalate (blue)		

Additional Specifications	
Dielectric Withstanding Voltage (VRMS)	3000