

GaAs-IR-Lumineszenzdiode
GaAs Infrared Emitter
Lead (Pb) Free Product - RoHS Compliant

SFH 405



Wesentliche Merkmale

- GaAs-IR-Lumineszenzdiode
- Hohe Zuverlässigkeit
- Gruppierbar
- Gehäusegleich mit SFH 305
- Miniatur-Gehäuse

Features

- GaAs infrared emitting diode
- High reliability
- Available in groups
- Same package as SFH 305
- Miniature package

Anwendungen

- Miniaturlichtschranken für Gleich- und Wechsellichtbetrieb
- Barcodeleser
- Industrieelektronik
- „Messen/Steuern/Regeln“
- Sensorik
- Drehzahlsteuerung

Applications

- Miniature photointerrupters
- Barcode readers
- Industrial electronics
- For control and drive circuits
- Sensor technology
- Speed controller

Typ Type	Bestellnummer Ordering Code	Gehäuse Package
SFH 405	Q62702P0835	Miniatur-Leiterbandgehäuse, klares Epoxy-Gießharz, linsenförmig, Anschluß im 2.54-mm-Raster ($\frac{1}{10}$ "), Kathodenkennzeichnung: abgeschrägte Anschlüsse Miniature lead frame, transparent epoxy resin, solder tabs lead spacing 2.54 mm ($\frac{1}{10}$ "), cathode marking: bevelled leads

Grenzwerte ($T_A = 25\text{ °C}$)**Maximum Ratings**

Bezeichnung Parameter	Symbol Symbol	Wert Value	Einheit Unit
Betriebs- und Lagertemperatur Operating and storage temperature range	$T_{op}; T_{stg}$	- 40 ... + 80	°C
Sperrspannung Reverse voltage	V_R	5	V
Durchlassstrom Forward current	I_F	40	mA
Stoßstrom, $\tau \leq 10\ \mu\text{s}$, $D = 0$ Surge current	I_{FSM}	1.6	A
Verlustleistung Power dissipation	P_{tot}	65	mW
Wärmewiderstand Thermal resistance	R_{thJA} R_{thJL}	950 850	K/W K/W

Kennwerte ($T_A = 25\text{ °C}$)**Characteristics**

Bezeichnung Parameter	Symbol Symbol	Wert Value	Einheit Unit
Wellenlänge der Strahlung Wavelength at peak emission $I_F = 40\text{ mA}$, $t_p = 20\text{ ms}$	λ_{peak}	950	nm
Spektrale Bandbreite bei 50% von I_{max} Spectral bandwidth at 50% of I_{max} $I_F = 50\text{ mA}$, $t_p = 20\text{ ms}$	$\Delta\lambda$	55	nm
Abstrahlwinkel Half angle	φ	± 16	Grad deg.
Aktive Chipfläche Active chip area	A	0.25	mm ²
Abmessungen der aktiven Chipfläche Dimensions of the active chip area	$L \times B$ $L \times W$	0.5×0.5	mm
Abstand Chipoberfläche bis Linsenscheitel Distance chip surface to lens top	H	1.3 ... 1.9	mm
Schaltzeiten, I_e von 10% auf 90% und von 90% auf 10%, bei $I_F = 40\text{ mA}$, $R_L = 50\ \Omega$ Switching times, I_e from 10% to 90% and from 90% to 10%, $I_F = 40\text{ mA}$, $R_L = 50\ \Omega$	t_r , t_f	1	μs

Kennwerte ($T_A = 25\text{ °C}$)

Characteristics (cont'd)

Bezeichnung Parameter	Symbol Symbol	Wert Value	Einheit Unit
Kapazität, Capacitance $V_R = 0\text{ V}, f = 1\text{ MHz}$	C_o	40	pF
Durchlassspannung Forward voltage $I_F = 40\text{ mA}$	V_F	1.25 (≤ 1.4)	V
Sperrstrom Reverse current $V_R = 5\text{ V}$	I_R	0.01 (≤ 1)	μA
Gesamtstrahlungsfluss Total radiant flux $I_F = 40\text{ mA}, t_p = 20\text{ ms}$	Φ_e	7	mW
Temperaturkoeffizient von I_e bzw. Φ_e , $I_F = 40\text{ mA}$ Temperature coefficient of I_e or Φ_e , $I_F = 40\text{ mA}$	TC_I	- 0.55	%/K
Temperaturkoeffizient von V_F , $I_F = 40\text{ mA}$ Temperature coefficient of V_F , $I_F = 40\text{ mA}$	TC_V	- 1.5	mV/K
Temperaturkoeffizient von λ_{peak} , $I_F = 40\text{ mA}$ Temperature coefficient of λ_{peak} , $I_F = 40\text{ mA}$	TC_λ	+ 0.3	nm/K

Strahlstärke I_e in Achsrichtunggemessen bei einem Raumwinkel $\Omega = 0.01\text{ sr}$ **Radiant Intensity I_e in Axial Direction**at a solid angle of $\Omega = 0.01\text{ sr}$

Bezeichnung Parameter	Symbol	Werte Values	Einheit Unit
Strahlstärke Radiant intensity $I_F = 40\text{ mA}, t_p = 20\text{ ms}$	I_e	2.5 (> 1.6)	mW/sr

Relative Spectral Emission

$I_{rel} = f(\lambda)$

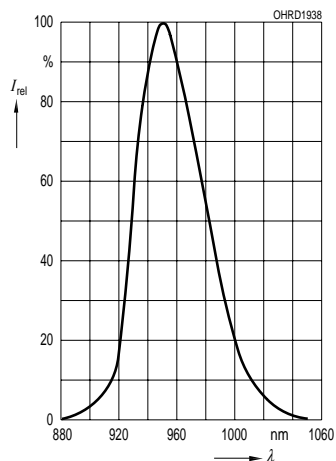

Radiant Intensity $\frac{I_e}{I_e 100 \text{ mA}} = f(I_F)$

Single pulse, $t_p = 20 \mu\text{s}$

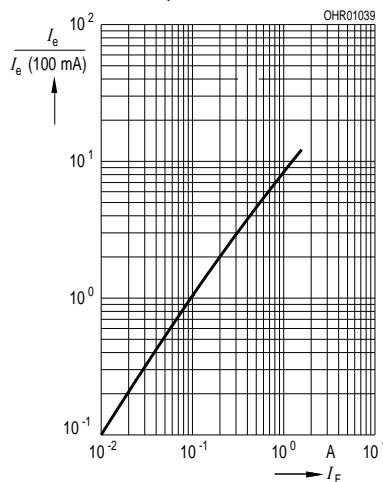

Max. Permissible Forward Current

$I_F = f(T_A)$

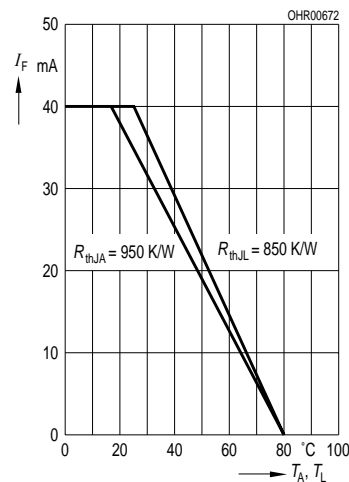

Forward Current

$I_F = f(V_F)$, Single pulse, $t_p = 20 \mu\text{s}$

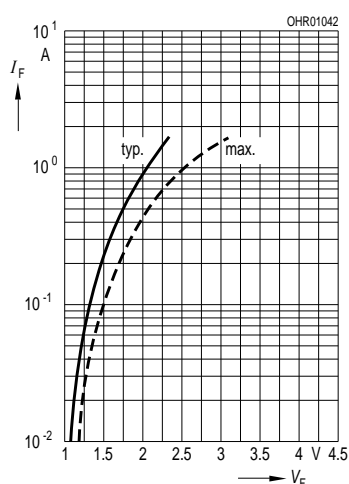

Permissible Pulse Handling Capability

$I_F = f(\tau)$, $T_A = 25^\circ\text{C}$, duty cycle $D = \text{parameter}$

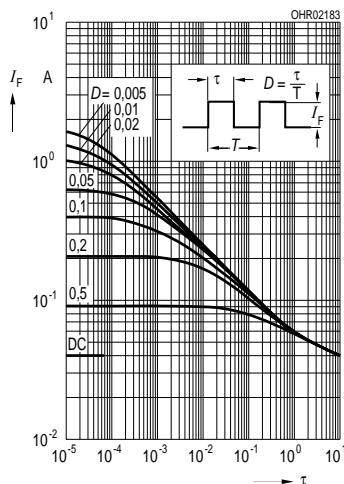

Radiation Characteristics

$I_{rel} = f(\varphi)$

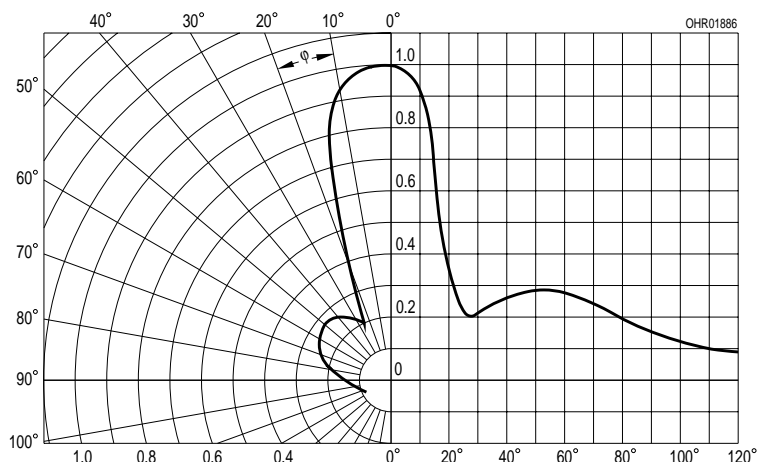

Maßzeichnung
Package Outlines

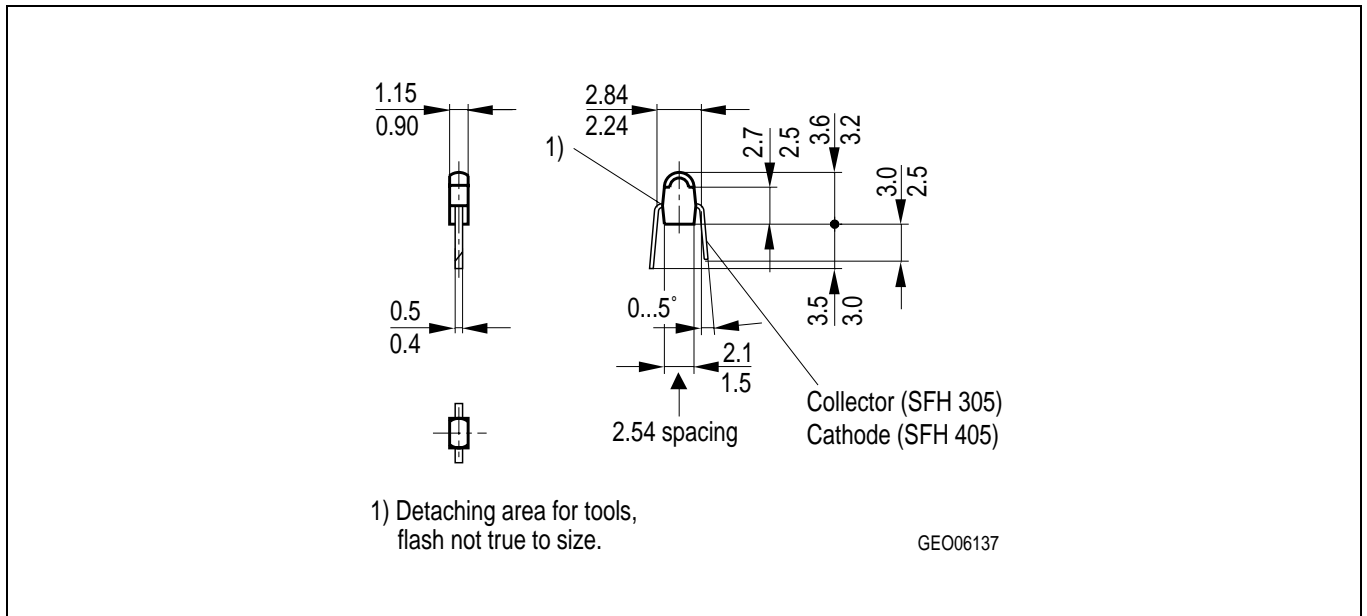

Maße in mm (inch) / Dimensions in mm (inch).

Lötbedingungen
Soldering Conditions
Wellenlöten (TTW)
TTW Soldering

(nach CECC 00802)
(acc. to CECC 00802)

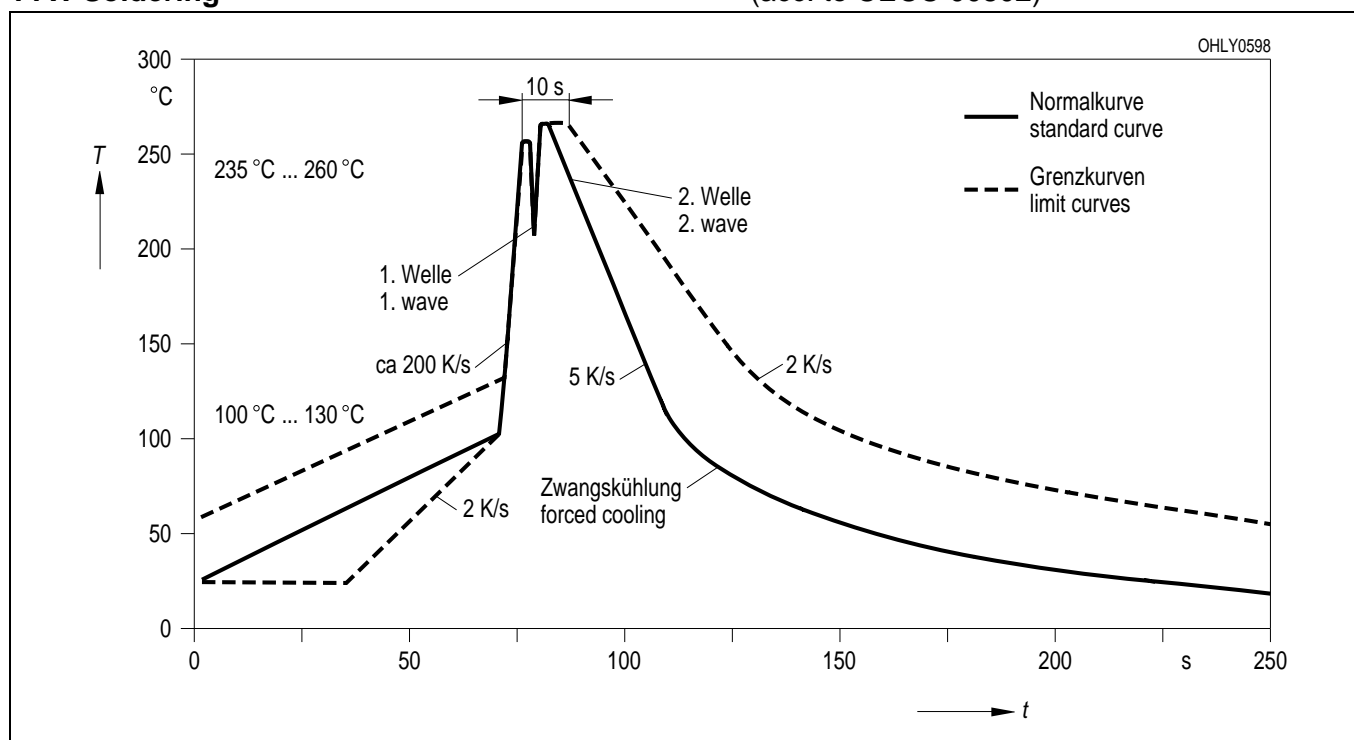

Published by
OSRAM Opto Semiconductors GmbH
Wernerwerkstrasse 2, D-93049 Regensburg

www.osram-os.com

© All Rights Reserved.

The information describes the type of component and shall not be considered as assured characteristics. Terms of delivery and rights to change design reserved. Due to technical requirements components may contain dangerous substances. For information on the types in question please contact our Sales Organization.

Packing

Please use the recycling operators known to you. We can also help you – get in touch with your nearest sales office. By agreement we will take packing material back, if it is sorted. You must bear the costs of transport. For packing material that is returned to us unsorted or which we are not obliged to accept, we shall have to invoice you for any costs incurred.

Components used in life-support devices or systems must be expressly authorized for such purpose! Critical components ¹, may only be used in life-support devices or systems ² with the express written approval of OSRAM OS.

¹ A critical component is a component used in a life-support device or system whose failure can reasonably be expected to cause the failure of that life-support device or system, or to affect its safety or effectiveness of that device or system.

² Life support devices or systems are intended (a) to be implanted in the human body, or (b) to support and/or maintain and sustain human life. If they fail, it is reasonable to assume that the health of the user may be endangered.

EU RoHS and China RoHS compliant product



此产品符合欧盟 RoHS 指令的要求；

按照中国的相关法规和标准，不含有毒有害物质或元素。

Mouser Electronics

Related Product Links

[720-SFH405 - Osram Opto Semiconductor SFH 405](#)