

# HDSP-311x, HDSP- 313x

10.16 mm (0.4 inch) Single Digit General Purpose  
Seven Segment Display

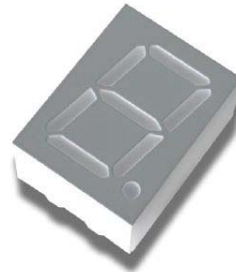

## Data Sheet



### Description

This 10.16 mm (0.4 inch) LED single digit seven segment display uses industry standard size package and pinout. The device is available in either common anode or common cathode. The choice of colors includes High Efficiency Red (HER), Green, AlGaAs Red, and Yellow. The gray face displays are suitable for indoor use.

### Applications

- Suitable for indoor use
- Not recommended for industrial application, i.e., operating temperature requirements exceeding +85° C or below -25° C [1]
- Extreme temperature cycling not recommended

Note:

1. For additional details, please contact your local Avago sales office or an authorized distributor.

### Features

- Industry standard size
- Industry standard pinout
  - 10.16 mm (0.4 inch) character height
  - DIP lead on 2.54 mm
- Choice of colors
  - High Efficiency Red (HER), Green, AlGaAs Red, and Yellow
- Excellent appearance
  - Evenly lighted segments gray package gives optimum contrast
  - ± 50 ft. viewing angle
- Design flexibility
  - Common anode right hand decimal point or common cathode right hand decimal point
- Categorized for luminous intensity
  - Green and yellow categorized for color

### Devices

HER	Green	AlGaAs Red	Yellow	Description	Package Drawing
HDSP-311E	HDSP-311G	HDSP-311A	HDSP-311Y	Common Anode Right Hand Decimal	A
HDSP-313E	HDSP-313G	HDSP-313A	HDSP-313Y	Common Cathode Right Hand Decimal	B

## Part Numbering System

5082 - x xx x - x x x xx

HDSP - x xx x - x x x xx

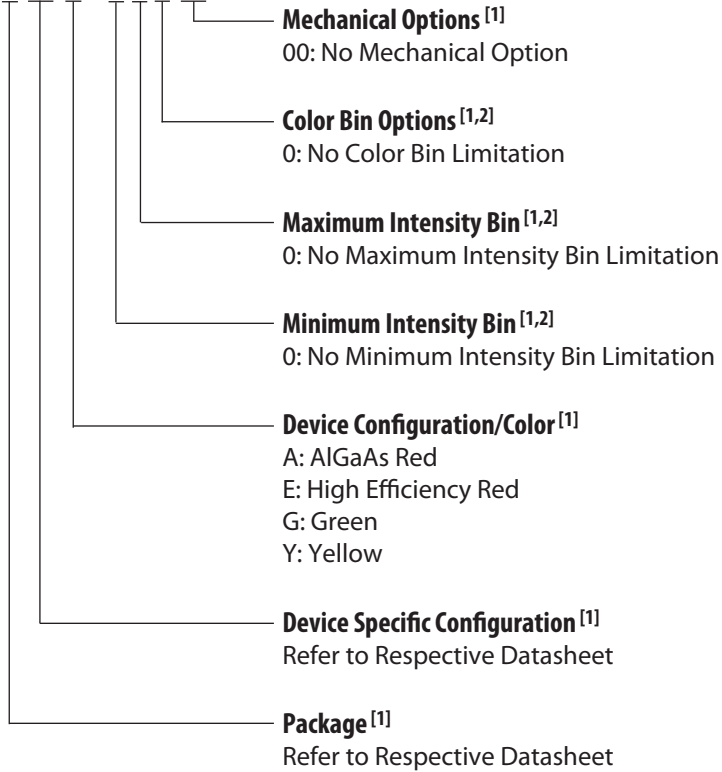

### Notes:

1. For codes not listed in the figure above, please refer to the respective datasheet or contact your nearest Avago representative for details.
2. Bin options refer to shippable bins for a part number. Color and Intensity Bins are typically restricted to 1 bin per tube (exceptions may apply). Please refer to respective datasheet for specific bin limit information.

# Package Dimensions

## Package Drawing A

FRONT VIEW

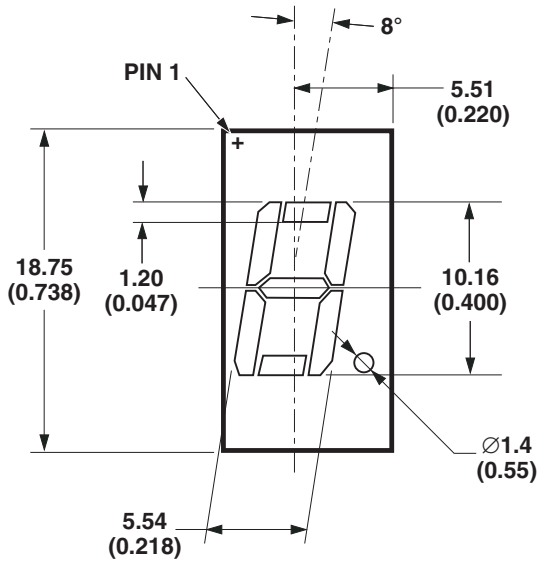

TOP END VIEW

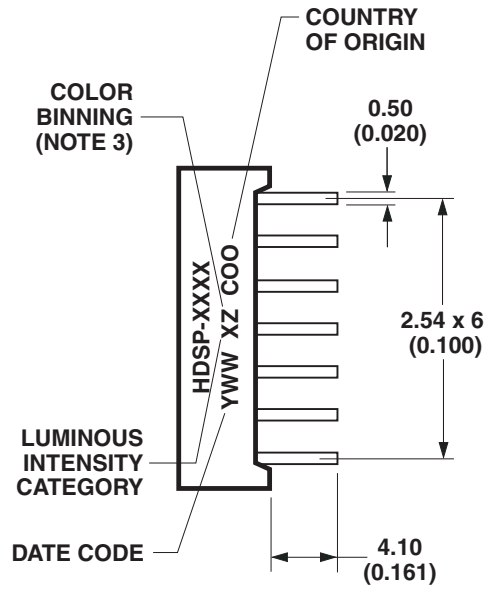

SIDE VIEW

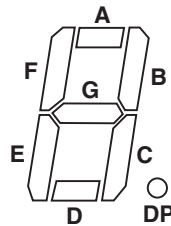
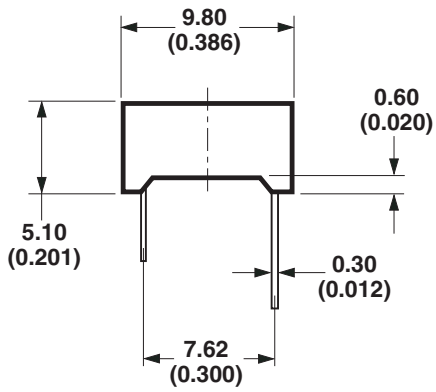

NOTE: NO PINS 4, 5, 6, AND 12

DIMENSIONS IN MILLIMETERS (INCHES)

# Package Dimensions

## Package Drawing B

FRONT VIEW

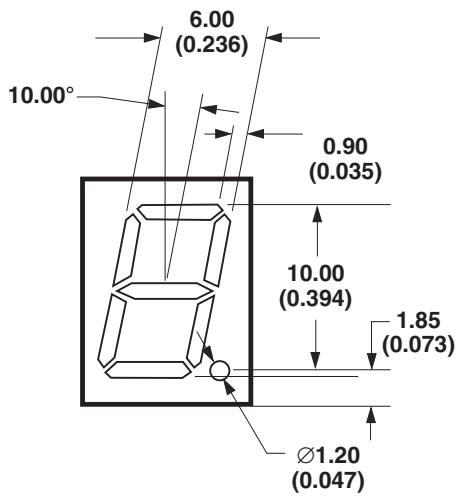

TOP SIDE

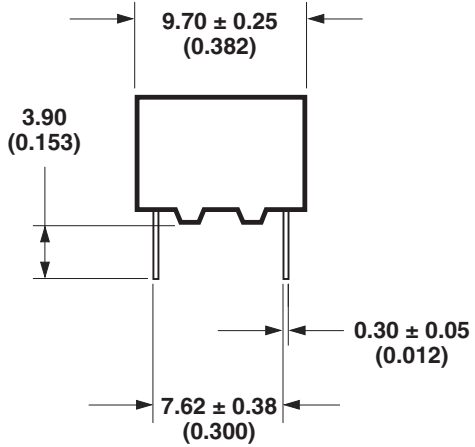

RIGHT SIDE

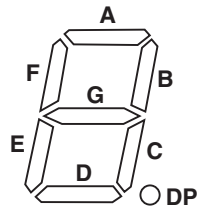
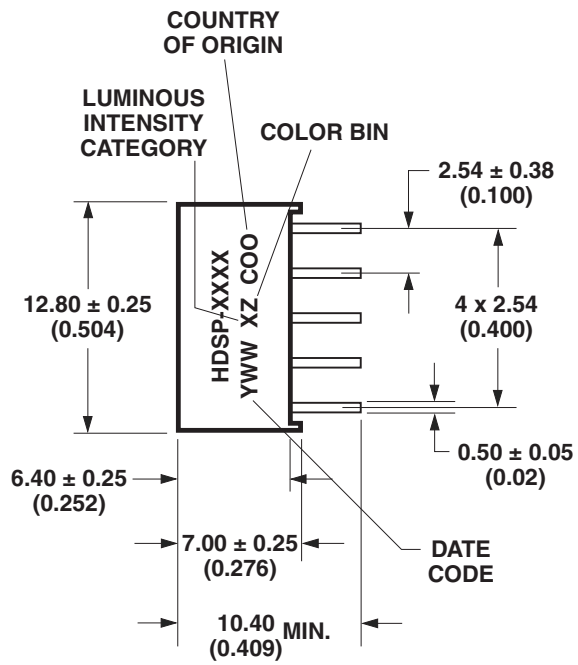

DIMENSIONS IN MILLIMETERS (INCHES)

## Internal Circuit Diagram

### COMMON ANODE RIGHT HAND DECIMAL

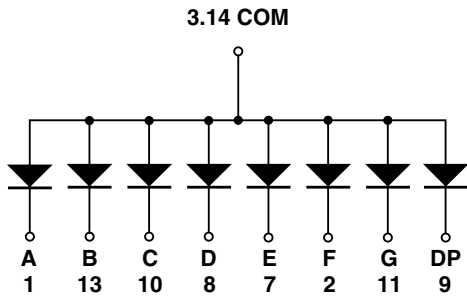

#### HDSP-311E/311G/311Y/311A

PIN No.	CONNECTION
1	CATHODE A
2	CATHODE F
3	COMMON ANODE
7	CATHODE E
8	CATHODE D
9	CATHODE DP
10	CATHODE C
11	CATHODE G
13	CATHODE B
14	COMMON ANODE
PINS 4, 5, 6, 12: NO PIN	

### COMMON CATHODE RIGHT HAND DECIMAL

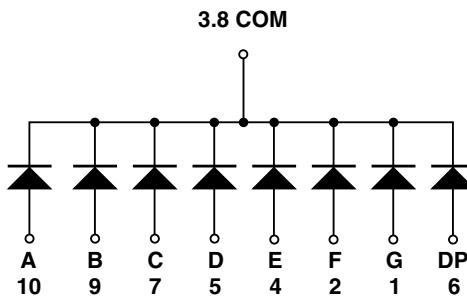

#### HDSP-313E/313G/313Y/313A

PIN NO.	CONNECTION
1	ANODE G
2	ANODE F
3	COMMON CATHODE
4	ANODE E
5	ANODE D
6	ANODE DP
7	ANODE C
8	COMMON CATHODE
9	ANODE B
10	ANODE A

## Absolute Maximum Ratings at $T_A = 25^\circ\text{C}$

Description	HER HDSP-31xE	Green HDSP-31xG	AlGaAs Red HDSP-31xA	Yellow HDSP-31xY	Units
Power Dissipation Segment	65	65	30	52	mW
Forward Current Segment	25 [1]	25 [2]	15 [3]	20 [4]	mA
Peak Forward Current per Segment (1/10 Duty Factor at 10 kHz)	100	100	80	80	mA
Operating Temperature Range	-35 to +85	-35 to +85	-35 to +85	-35 to +85	$^\circ\text{C}$
Storage Temperature Range	-35 to +85	-35 to +85	-35 to +85	-35 to +85	$^\circ\text{C}$
Reverse Voltage per Segment or DP	5	5	5	5	V
Wavesoldering Temperature for 3 Seconds (at 2 mm Distance from the Body)	250	250	250	250	$^\circ\text{C}$

Note:

1. Derate above  $25^\circ\text{C}$  at  $0.33\text{ mA}/^\circ\text{C}$ .
2. Derate above  $25^\circ\text{C}$  at  $0.33\text{ mA}/^\circ\text{C}$ .
3. Derate above  $25^\circ\text{C}$  at  $0.2\text{ mA}/^\circ\text{C}$ .
4. Derate above  $25^\circ\text{C}$  at  $0.27\text{ mA}/^\circ\text{C}$ .

## Electrical/Optical Characteristics at $T_A = 25^\circ\text{C}$

### High Efficiency Red (HER)

Device HDSP-	Parameter	Symbol	Min.	Typ.	Max.	Units	Test Conditions
311E 313E	Luminous Intensity/Segment	$I_V$		1.49		mcd	$I_F = 5\text{ mA}$
			1.25	3.20			$I_F = 10\text{ mA}$
	Forward Voltage	$V_F$		2.05	2.40	V	$I_F = 20\text{ mA}$
	Peak Wavelength	$\lambda_{\text{PEAK}}$		635		nm	
	Dominant Wavelength	$\lambda_d$		620		nm	
	Reverse Voltage	$V_R$	5			V	$I_R = 100\ \mu\text{A}$

### Green

Device HDSP-	Parameter	Symbol	Min.	Typ.	Max.	Units	Test Conditions
311G 313G	Luminous Intensity/Segment	$I_V$	1.25	3.20		mcd	$I_F = 10\text{ mA}$
							$I_F = 20\text{ mA}$
	Forward Voltage	$V_F$		2.06		V	$I_F = 10\text{ mA}$
			1.80	2.25	2.60		$I_F = 20\text{ mA}$
	Peak Wavelength	$\lambda_{\text{PEAK}}$		568		nm	
	Dominant Wavelength	$\lambda_d$		573		nm	
	Reverse Voltage	$V_R$	5			V	$I_R = 100\ \mu\text{A}$

## AlGaAs Red

Device HDSP-	Parameter	Symbol	Min.	Typ.	Max.	Units	Test Conditions
311A 313A	Luminous Intensity/Segment	$I_V$		4.54		mcd	$I_F = 5 \text{ mA}$
			3.20	7.50			$I_F = 10 \text{ mA}$
	Forward Voltage	$V_F$		1.85	2.00	V	$I_F = 20 \text{ mA}$
	Peak Wavelength	$\lambda_{PEAK}$		660		nm	
	Dominant Wavelength	$\lambda_d$		643		nm	
	Reverse Voltage	$V_R$	5			V	$I_R = 100 \mu\text{A}$

## Yellow

Device HDSP-	Parameter	Symbol	Min.	Typ.	Max.	Units	Test Conditions
311Y 313Y	Luminous Intensity/Segment	$I_V$		0.86		mcd	$I_F = 5 \text{ mA}$
			0.80	1.50			$I_F = 10 \text{ mA}$
	Forward Voltage	$V_F$		2.15	2.60	V	$I_F = 20 \text{ mA}$
	Peak Wavelength	$\lambda_{PEAK}$		595		nm	
	Dominant Wavelength	$\lambda_d$		590		nm	
	Reverse Voltage	$V_R$	5			V	$I_R = 100 \mu\text{A}$

## Intensity Bin Limits (mcd at 10 mA)

Bin Name	HER/Green		Yellow		AlGaAs Red	
	Min. [1]	Max. [1]	Min. [1]	Max. [1]	Min. [1]	Max. [1]
G	NA	NA	0.801	1.250	NA	NA
H	1.251	2.000	1.251	2.000	NA	NA
I	2.001	3.200	2.001	3.200	NA	NA
J	3.201	5.050	NA	NA	3.201	5.050
K	NA	NA	NA	NA	5.051	8.000
L	NA	NA	NA	NA	8.001	12.650

Note:

1. Tolerance for each bin limit is  $\pm 10\%$ .

## Color Bin Limits (nm at 10 mA)

Color	Bin	Dominant Wavelength (nm)	
		Min.	Max.
Green	3	569.1	571.1
	4	571.1	573.1
	5	573.1	585.5
Yellow	1	585.5	588.5
	2	588.5	591.5
	3	591.5	594.5

Note:

1. Tolerance for each bin limit is 1 nm.

## High Efficiency Red (HER)

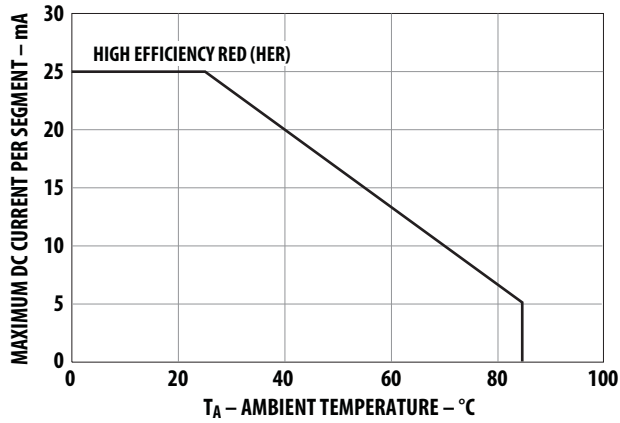

Figure 1. Maximum allowable average or DC current vs. ambient temperature.

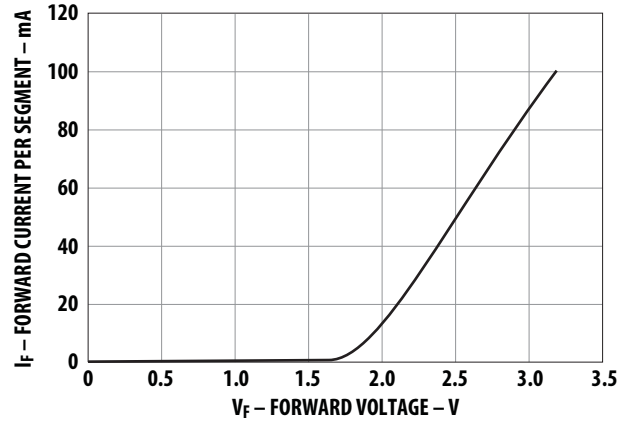

Figure 2. Forward current vs. forward voltage.

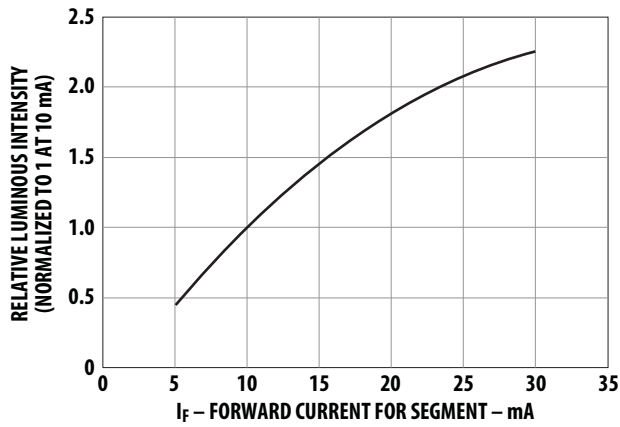

Figure 3. Relative luminous intensity vs. DC forward current.

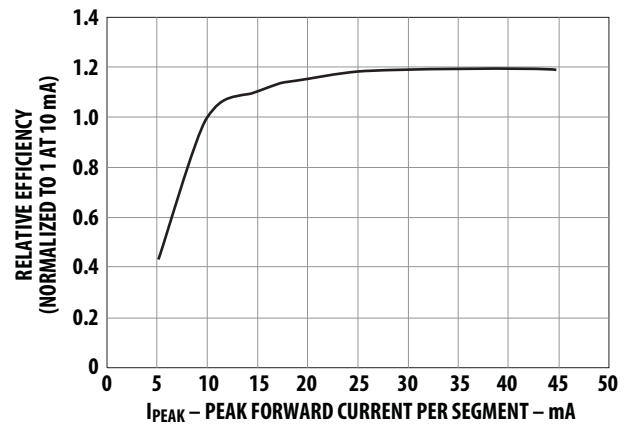

Figure 4. Relative efficiency (luminous intensity per unit current) vs. peak current.



## Green

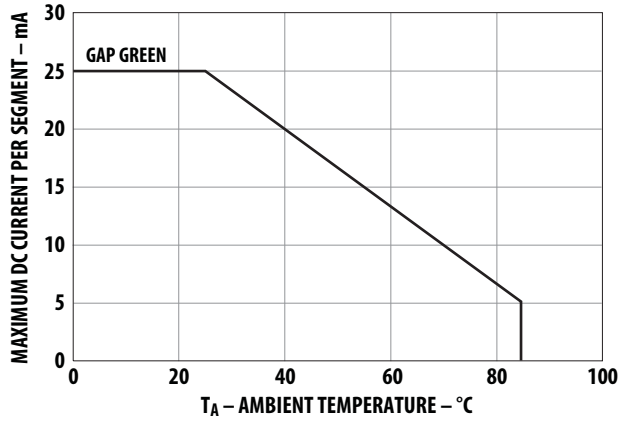

Figure 5. Maximum allowable average or DC current vs. ambient temperature.

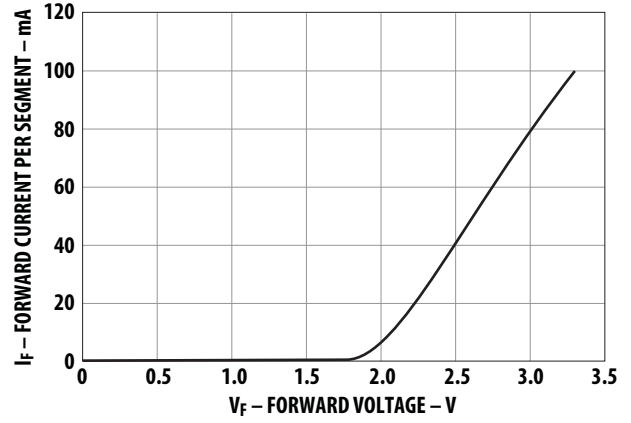

Figure 6. Forward current vs. forward voltage.

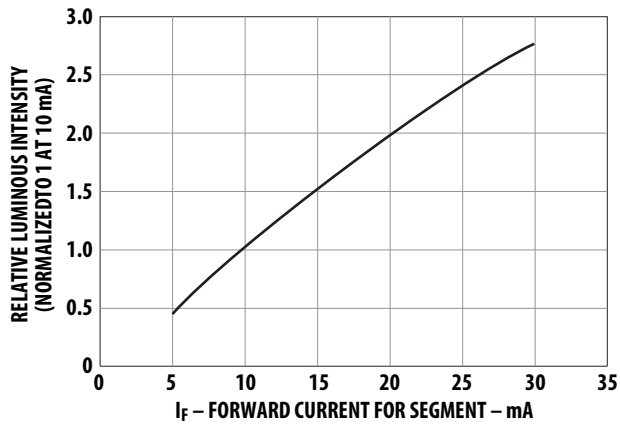

Figure 7. Relative luminous intensity vs. DC forward current.

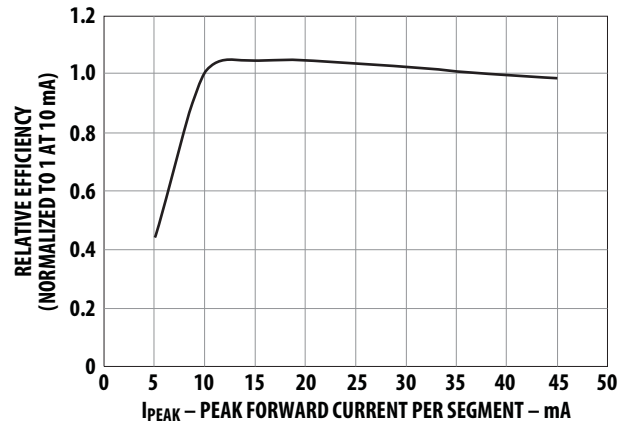

Figure 8. Relative efficiency (luminous intensity per unit current) vs. peak current.

## AlGaAs Red

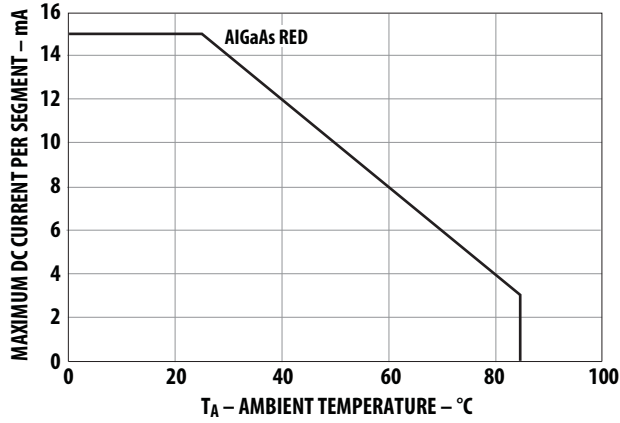

Figure 9. Maximum allowable average or DC current vs. ambient temperature.

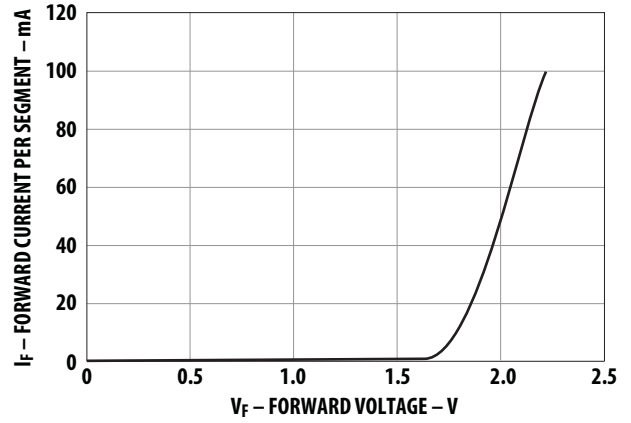

Figure 10. Forward current vs. forward voltage.

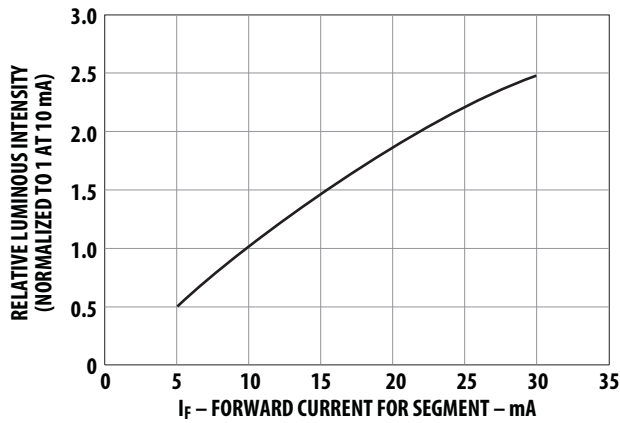

Figure 11. Relative luminous intensity vs. DC forward current.

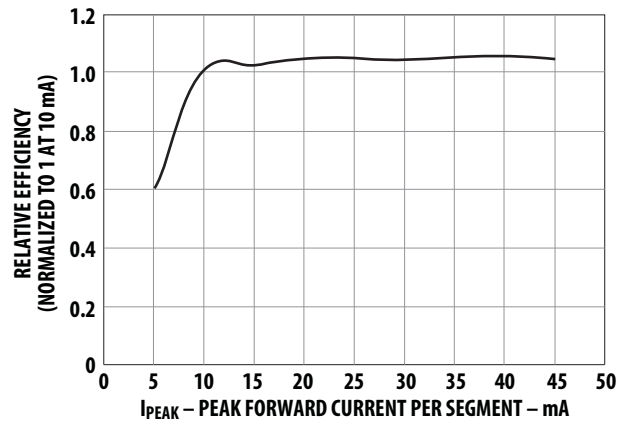

Figure 12. Relative efficiency (luminous intensity per unit current) vs. peak current.

## Yellow

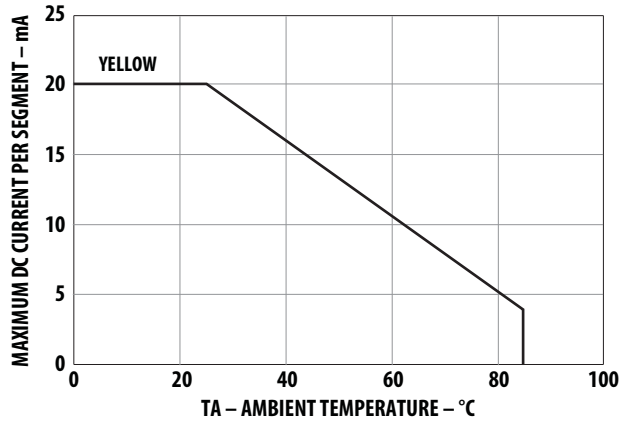

Figure 13. Maximum allowable average or DC current vs. ambient temperature.

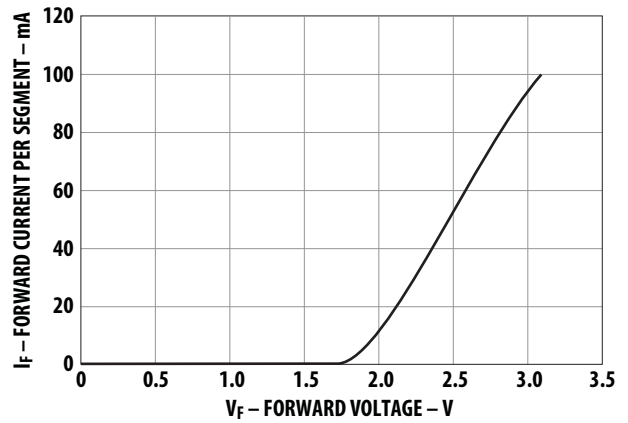

Figure 14. Forward current vs. forward voltage.

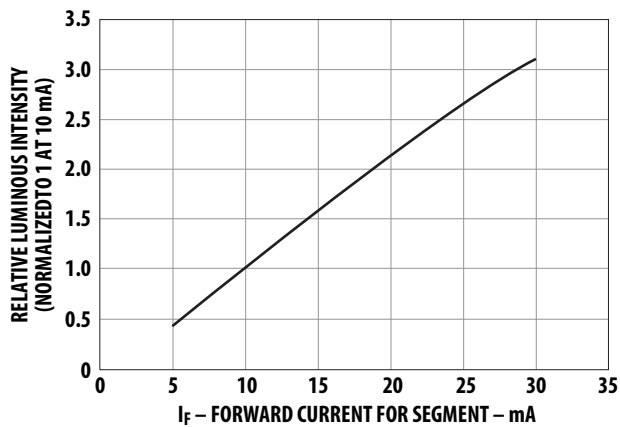

Figure 15. Relative luminous intensity vs. DC forward current.

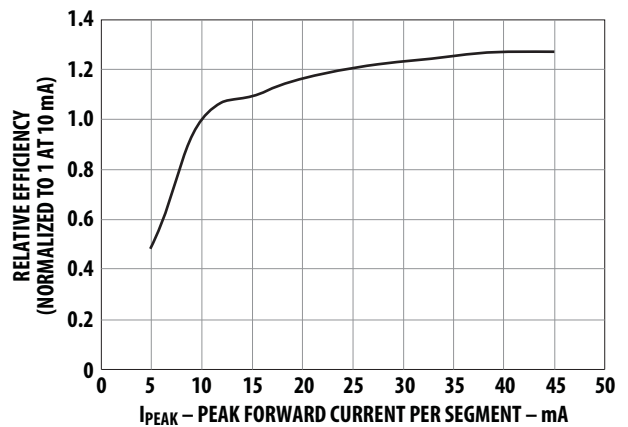

Figure 16. Relative efficiency (luminous intensity per unit current) vs. peak current.

For product information and a complete list of distributors, please go to our web site: [www.avagotech.com](http://www.avagotech.com)

Avago, Avago Technologies, and the A logo are trademarks of Avago Technologies in the United States and other countries. Data subject to change. Copyright © 2005-2012 Avago Technologies. All rights reserved. Obsoletes 5988-2969EN AV02-3585EN - June 11, 2012

**AVAGO**  
TECHNOLOGIES