

Solid State Relays G3PA

Extremely Thin Relays Integrated with Heat Sinks

- Downsizing achieved through optimum design of heat sink.
- Mounting possible via screws or via DIN track.
- Close mounting possible for linking terminals. (Except for G3PA-260B-VD and G3PA-450B-VD-2.)
- Applicable with 3-phase loads.
- Replaceable power element cartridges.
- Complies with VDE 0160 (finger protection), with a dielectric strength of 4,000 V between input and load.
- Complies with VDE 0805, IEC 950.
- Certified by UL, CSA, and VDE (reinforced insulation).



Ordering Information

List of Models

To Order: Select the part number and add the rated input voltage range. (e.g., G3PA-430B-VD-2 DC12-24)

Isolation	Zero cross function	Indicator	Rated output load	Rated input voltage	Model	
Phototriac coupler	Yes	Yes	10 A at 24 to 240 VAC	5 to 24 VDC	G3PA-210B-VD	
			20 A at 24 to 240 VAC		G3PA-220B-VD	
			40 A at 24 to 240 VAC		G3PA-240B-VD	
			60 A at 24 to 240 VAC		G3PA-260B-VD	
	No		10 A at 24 to 240 VAC		G3PA-210BL-VD	
			20 A at 24 to 240 VAC		G3PA-220BL-VD	
			40 A at 24 to 240 VAC		G3PA-240BL-VD	
			60 A at 24 to 240 VAC		G3PA-260BL-VD	
	Yes		10 A at 24 to 240 VAC	24 VAC	G3PA-210B-VD	
			20 A at 24 to 240 VAC		G3PA-220B-VD	
			40 A at 24 to 240 VAC		G3PA-240B-VD	
			60 A at 24 to 240 VAC		G3PA-260B-VD	
				20 A at 180 to 400 VAC	12 to 24 VDC	G3PA-420B-VD
				30 A at 180 to 400 VAC		G3PA-430B-VD
				20 A at 200 to 480 VAC		G3PA-420B-VD-2
				30 A at 200 to 480 VAC		G3PA-430B-VD-2
		50 A at 200 to 480 VAC		G3PA-450B-VD-2		

Replacement Parts

Name	Carry current	Load voltage range	Applicable SSR	Model	VDE certification
Power Device Cartridge	10 A	19 to 264 VAC	G3PA-210B-VD DC5-24	G32A-A10-VD DC5-24	Yes
			G3PA-210BL-VD DC5-24	G32A-A10L-VD DC5-24	
			G3PA-210B-VD AC24	G32A-A10-VD AC24	
			G3PA-220B-VD DC5-24	G32A-A20-VD DC5-24	
	G3PA-220BL-VD DC5-24		G32A-A20L-VD DC5-24		
	G3PA-220B-VD AC24		G32A-A20-VD AC24		
	G3PA-240B-VD DC5-24		G32A-A40-VD DC5-24		
	G3PA-240BL-VD DC5-24		G32A-A40L-VD DC5-24		
	20 A	150 to 440 VAC	G3PA-240B-VD AC24	G32A-A40-VD AC24	
			G3PA-260B-VD DC5-24	G32A-A60-VD DC5-24	
			G3PA-260BL-VD DC5-24	G32A-A60L-VD DC5-24	
			G3PA-260B-VD AC24	G32A-A60-VD AC24	
	40 A	180 to 528 VAC	G3PA-420B-VD DC12-24	G32A-A420-VD DC12-24	
			G3PA-430B-VD DC12-24	G32A-A430-VD DC12-24	
	60 A	180 to 528 VAC	G3PA-420B-VD-2 DC12-24	G32A-A420-VD-2 DC12-24	
			G3PA-430B-VD-2 DC12-24	G32A-A430-VD-2 DC12-24	
G3PA-450B-VD-2 DC12-24			G32A-A450-VD-2 DC12-24		

Specifications

■ Ratings (at an Ambient Temperature of 25°C)

Input

Model	Rated voltage	Operating Voltage range	Input current impedance	Voltage level	
				Must operate voltage	Must release voltage
G3PA-2□□B-VD	5 to 24 VDC	4 to 30 VDC	7 mA max.	4 VDC max.	1 VDC min.
G3PA-2□□BL-VD			20 mA max.		
G3PA-2□□B-VD	24 VAC	19.2 to 26.4 VAC	1.4 kΩ±20%	19.2 VAC max.	4.8 VAC min.
G3PA-4□□B-VD(-2)	12 to 24 VDC	9.6 to 30 VDC	7 mA max.	9.2 VDC max.	1 VDC min.

Output

Model	Applicable load			
	Rated load voltage	Load voltage range	Load current	Inrush current
G3PA-210B(L)-VD	24 to 240 VAC (50/60 Hz)	19 to 264 VAC (50/60 Hz)	0.1 to 10 A	150 A (60 Hz, 1 cycle)
G3PA-220B(L)-VD			0.1 to 20 A	220 A (60 Hz, 1 cycle)
G3PA-240B(L)-VD			0.5 to 40 A	440 A (60 Hz, 1 cycle)
G3PA-260B(L)-VD			0.5 to 60 A	440 A (60 Hz, 1 cycle)
G3PA-420B-VD	180 to 400 VAC (50/60 Hz)	150 to 440 VAC (50/60 Hz)	0.5 to 20 A	220 A (60 Hz, 1 cycle)
G3PA-430B-VD			0.5 to 30 A	440 A (60 Hz, 1 cycle)
G3PA-420B-VD-2	200 to 480 VAC (50/60 Hz)	180 to 528 VAC (50/60 Hz)	0.5 to 20 A	220 A (60 Hz, 1 cycle)
G3PA-430B-VD-2			0.5 to 30 A	440 A (60 Hz, 1 cycle)
G3PA-450B-VD-2			0.5 to 50 A	440 A (60 Hz, 1 cycle)

Refer to *Engineering Data* for further details.

■ Characteristics

Item	G3PA-210B(L)-VD	G3PA-220B(L)-VD	G3PA-240B(L)-VD	G3PA-260B(L)-VD	G3PA-420B-VD	G3PA-420B-VD-2	G3PA-430B-VD	G3PA-430B-VD-2	G3PA-450B-VD-2
Operate time	1/2 of load power source cycle + 1 ms max. (DC Input, -B models) 1 1/2 of load power source cycle + 1 ms max. (AC Input) 1 ms max. (-BL models)								
Release time	1/2 of load power source cycle + 1 ms max. (DC Input) 1 1/2 of load power source cycle + 1 ms max. (AC Input)								
Output ON voltage drop	1.6 V (RMS) max.				1.8 V (RMS) max.				
Leakage current	5 mA max. (at 100 VAC) 10 mA max. (at 200 VAC)		10 mA max. (at 100 VAC) 20 mA max. (at 200 VAC)		20 mA max. (at 400 VAC)	20 mA max. (at 480 VAC)	20 mA max. (at 400 VAC)	20 mA max. (at 480 VAC)	
I ² t	260 A ² s		1,260 A ² s		260 A ² s	1,800 A ² s	1,800 A ² s		1,800 A ² s
Insulation resistance	100 MΩ min. (at 500 VDC)								
Dielectric strength	4,000 VAC, 50/60 Hz for 1 min								
Vibration resistance	Malfunction: 10 to 55, 0.75-mm double amplitude (Mounted to DIN track)								
Shock resistance	Malfunction: 300 m/s ² (mounted to DIN track)								
Ambient temperature	Operating: -30°C to 80°C (with no icing or condensation) Storage: -30°C to 100°C (with no icing or condensation)								
Certified standards	UL, CSA, EN60950 File No. 5915ÜG				UL, CSA, EN60947-4-3 File No. 6642ÜG	UL, CSA, EN60947-4-3 File No. 133127ÜG	UL, CSA, EN60947-4-3 File No. 6642ÜG	UL, CSA, EN60947-4-3 File No. 133127ÜG	
Ambient humidity	Operating: 45% to 85%								
Weight	Approx. 260 g	Approx. 340 g	Approx. 460 g	Approx. 900 g	Approx. 290 g	Approx. 290 g	Approx. 410 g	Approx. 410 g	Approx. 900 g

Operation

■ Replacement Parts

G32A-A Power Device Cartridge

The G32A-A Power Device Cartridge (a Triac Unit) can be replaced with a new one. When the temperature indicator has changed from pink to red, the triac circuitry may have malfunctioned possibly by an excessive flow of current, in which case, dismount the damaged cartridge for replacement.

The damaged cartridge can be replaced with a new one without disconnecting the wires from the G3PA.

Improve the heat radiation efficiency of the G3PA before replacing the cartridge.

The G32A-A Power Device Cartridge can withstand an excessive current for a short period of time, such as may be caused accidentally by the short circuitry of the load, in which case the temperature indicator will not turn red.

Be sure to turn OFF the power supply when replacing the Cartridge. Supplying power with the Cartridge removed may result in malfunction.

Appearance

G32A-A10(L)-VD G32A-A20(L)-VD G32A-A40(L)-VD G32A-A60(L)-VD

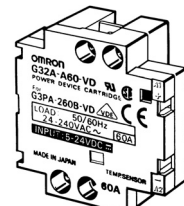
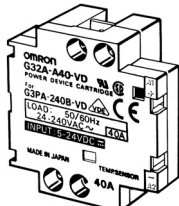
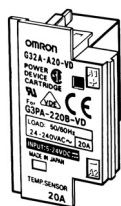
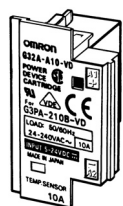

G32A-A420-VD(-2) G32A-A430-VD(-2) G32A-A450-VD-2

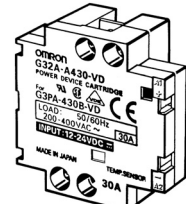
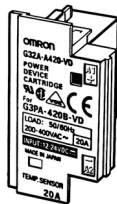

Replacing Power Device Cartridges

When replacing Power Device Cartridges, use the specified model. Using a Power Device Cartridge other than the specified one will result in faulty operation and destruction of the elements.

■ Replacement Procedure

G32A-A10(L)-VD/G32A-A20(L)-VD/G32-A420-VD(-2)

Use the special tool (provided) to extract the cartridge for replacement with a new one.

Extraction

Follow the procedures below to remove the Power Device Cartridge from the G3PA.

1. **Switch off the power.**
2. Remove the terminal cover.
3. Hook the indented part of the cartridge with the tool (supplied with a new cartridge) and pull up on the cartridge to remove it.

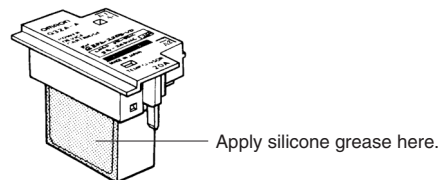
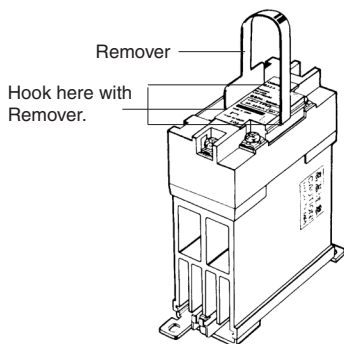

2. Make sure that there is no dust or pieces of wire on the heat sink of the G32A-A or the G3PA.
3. Insert the cartridge into the opening of the G3PA so that the letters on the cartridge and those on the G3PA are in the same direction and side A and side B are even.

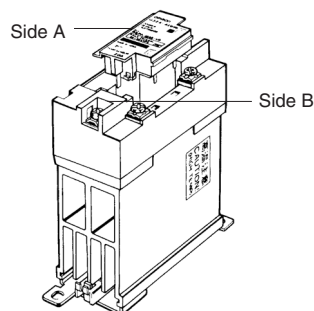

Installation

Follow the procedures below to Install the Power Device Cartridge on the G3PA.

1. Apply silicone grease (provided with the G32A-A) to the entire surface of the heat sink.

4. Attach the terminal cover.
5. Switch on the power and check the G3PA to be sure it works properly.

G32A-A40(L)-VD/G32A-A60(L)-VD/G32A-A430-VD(-2)/G32A-A450-VD-2

The G32A Power Device Cartridge is mounted and secured with screws to the G3PA Unit.

Extraction

Follow the procedures below to remove the G32A-A Power Device Cartridge from the G3PA.

1. **Switch off the power.**
2. Remove the terminal cover.
3. Loosen the two centered screws on the sides to dismount the cartridge. The screws are connected to terminals 1 and 2.

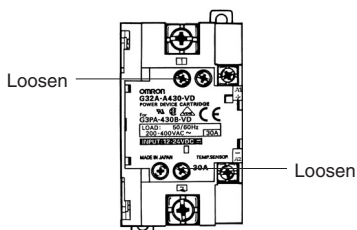

4. Loosen the screws on both the corners.

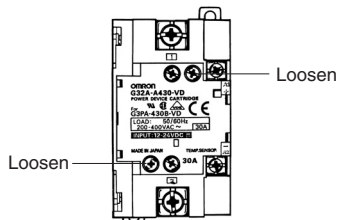

5. Hold the indented part of both the corners to remove the cartridge.

Installation

Follow the procedures below to Install the Power Device Cartridge on the G3PA.

1. Apply silicone grease to the entire surface of the heat sink.

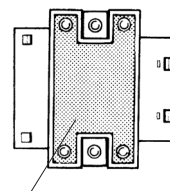

2. Make sure that there is no dust or pieces of wire on the heat sink of the G32A-A or the G3PA.

3. Insert the cartridge into the opening of the G3PA so that side A and side B are even.

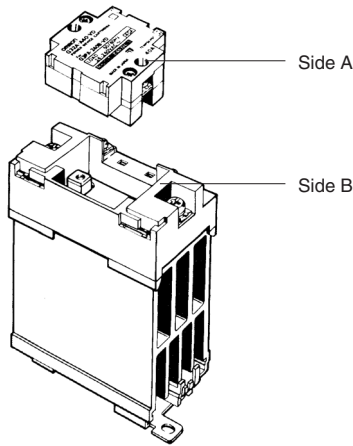

4. Tighten the screws on both the corners with a tightening torque of 0.59 to 0.78 N•m.
5. Tighten the screws on both the sides with a tightening torque of 0.59 to 0.78 N•m.
6. Attach the terminal cover.
7. Switch on the power and check the G3PA to be sure it works properly.

■ Linking Terminal Connection

- Connecting with linking terminal for G3PA-210B(L)-VD, -220B(L)-VD, -240B(L)-VD and G3PA-420B-VD(-2), G3PA-430B-VD(-2).

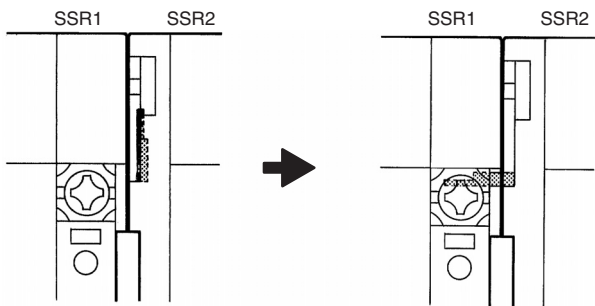

1. When SSRs are close mounted, loosen the M3.5 Sems screw and flip the linking terminal down.

2. Insert the linking terminal securely into the center of the screw and tighten the screw.

- Connecting with linking terminal to "G32A-D" series short circuit unit. (Order short circuit units separately.)

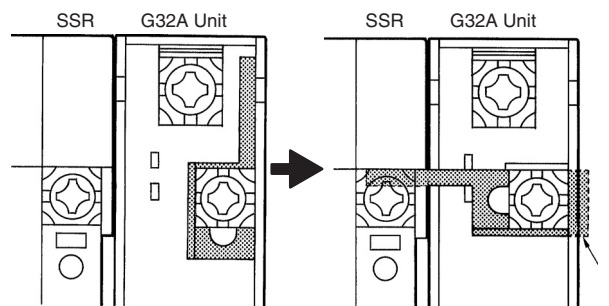

1. When SSR are close mounted, loosen the M3.5 Sems screw on the G32A and flip the linking terminal down.

* The cover will not fit if the terminal protrudes.

2. Insert the linking terminal securely into the center of the screw and tighten the screw. Ensure that the linking terminal does not protrude.

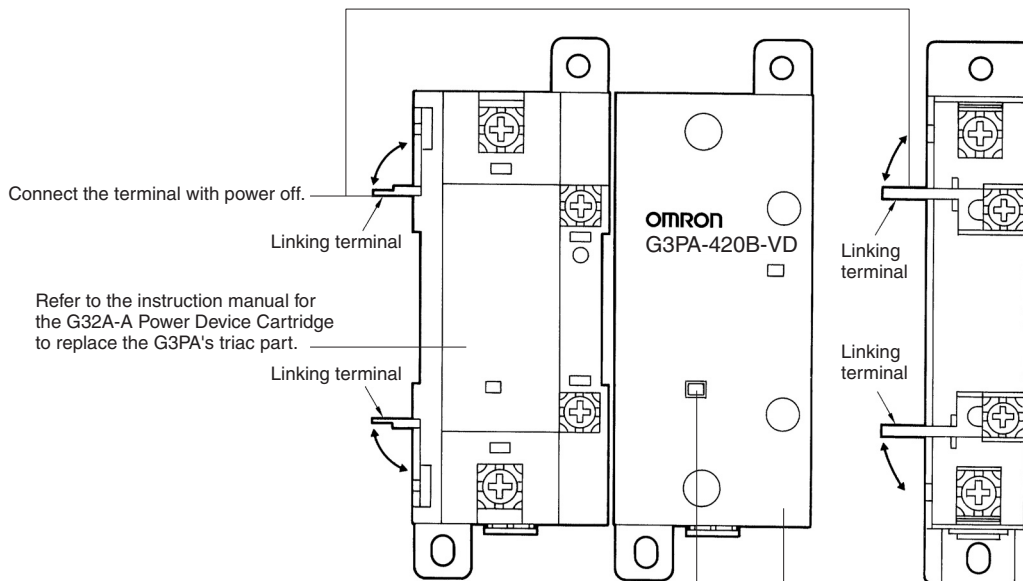

When the temperature indicator has turned from pink to red, the G32A-A Power Device Cartridge may have malfunctioned, in which case the cartridge must be replaced with a new one.

Use the terminal cover to prevent accidents due to electric shock.

Engineering Data

Load Current vs. Ambient Temperature

Vertical Mounting

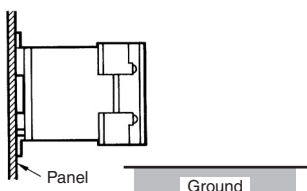

G3PA-210B(L)-VD, G3PA-220B(L)-VD

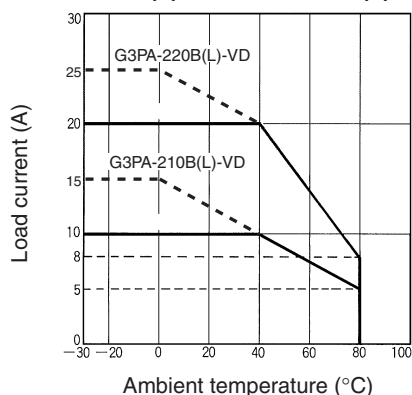

G3PA-240B(L)-VD

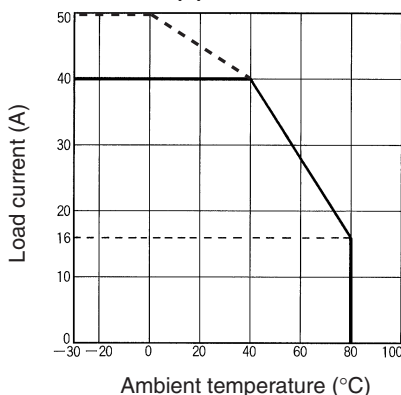

G3PA-260B(L)-VD

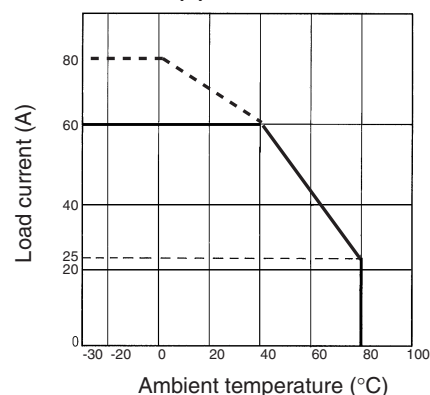

G3PA-420B-VD, G3PA-420B-VD-2

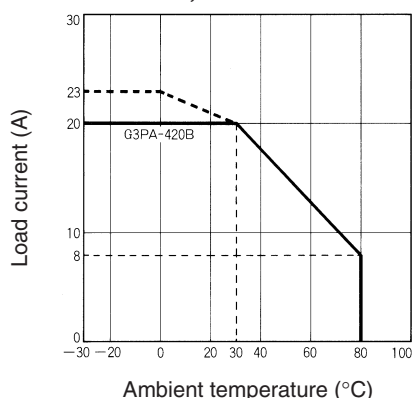

G3PA-430B-VD, G3PA-430B-VD-2

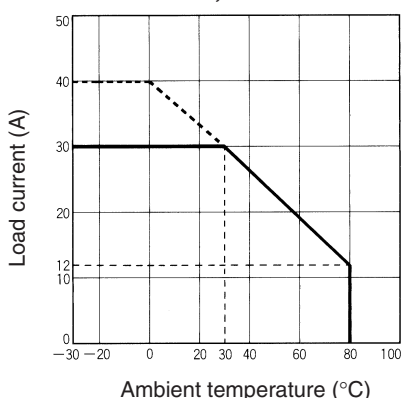

G3PA-450B-VD-2

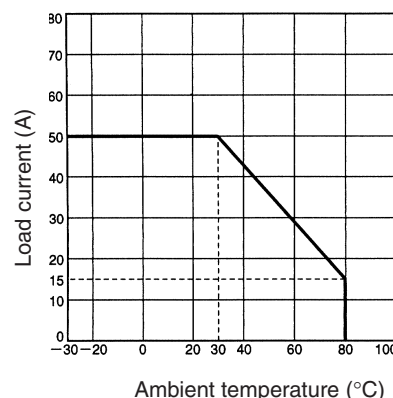

Note: Close mounting is possible for a maximum of three Units by reducing the load current by 20%. (A minimum clearance of 10 mm must be provided when mounting four or more Units.)

Input Voltage vs. Input Current

G3PA-2□0B-VD

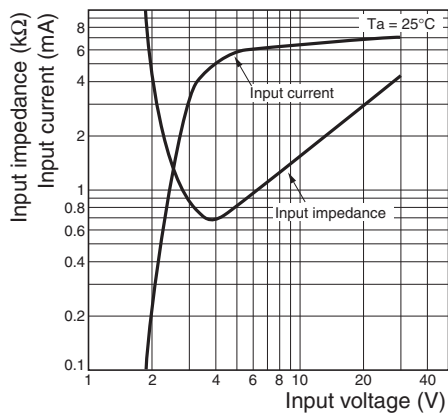

G3PA-4□0-VD, G3PA-4□-VD-2

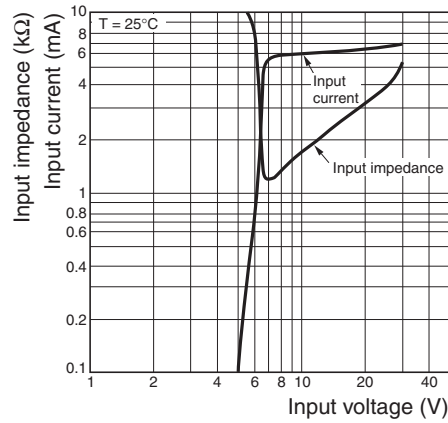

Horizontal Mounting

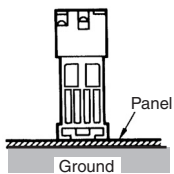

G3PA-210B(L)-VD, G3PA-220B(L)-VD

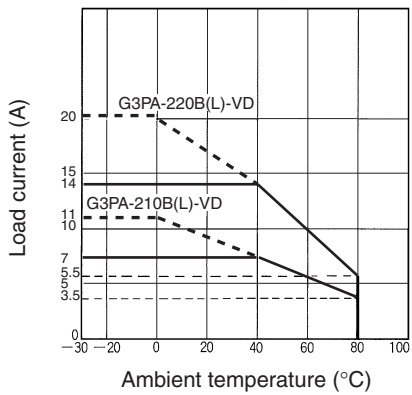

G3PA-240B(L)-VD

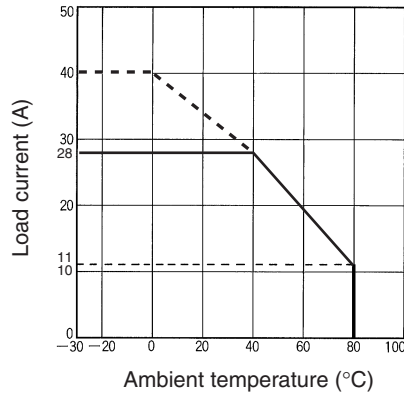

G3PA-260B(L)-VD

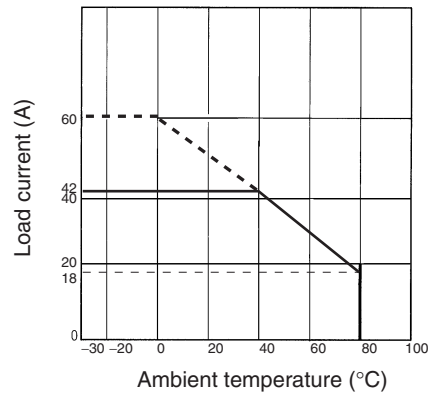

G3PA-420B-VD, G3PA-430B-VD
G3PA-420B-VD-2, G3PA-430B-VD-2

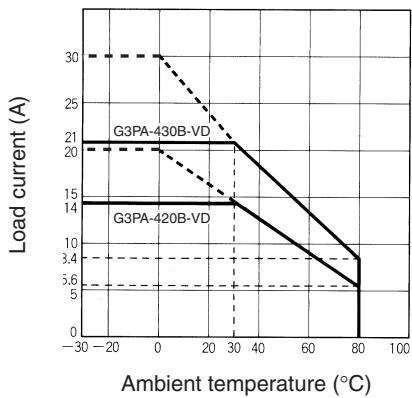

G3PA-450B-VD-2

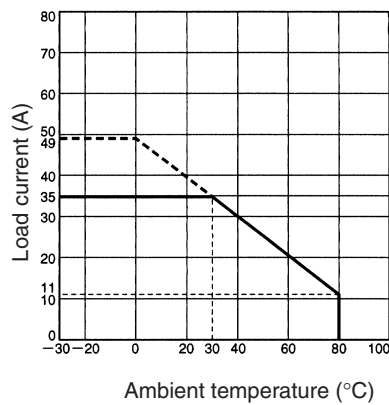

Close Mounting (Up to Three)

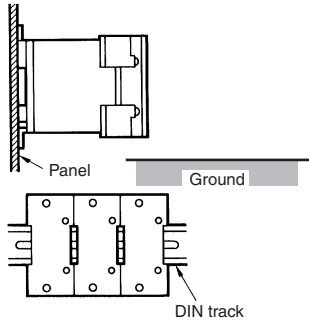

G3PA-210B(L)-VD, G3PA-220B(L)-VD

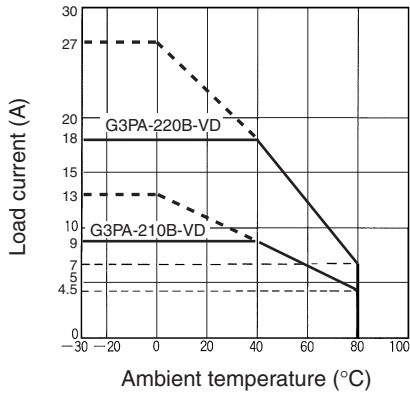

G3PA-240B(L)-VD

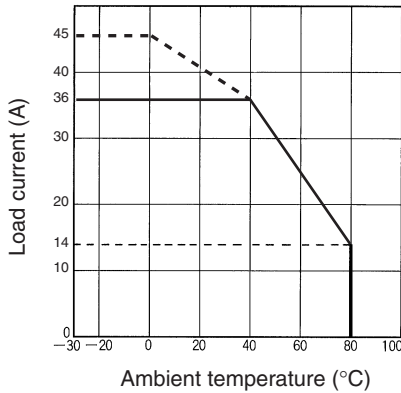

G3PA-260B(L)-VD

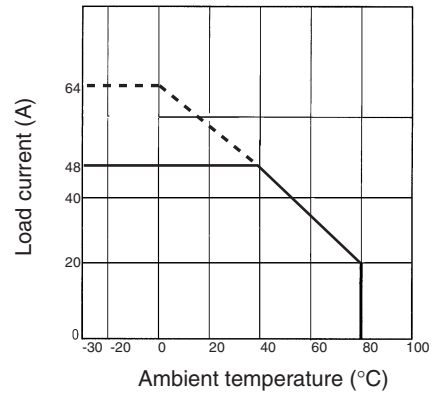

G3PA-420B-VD, G3PA-420B-VD-2

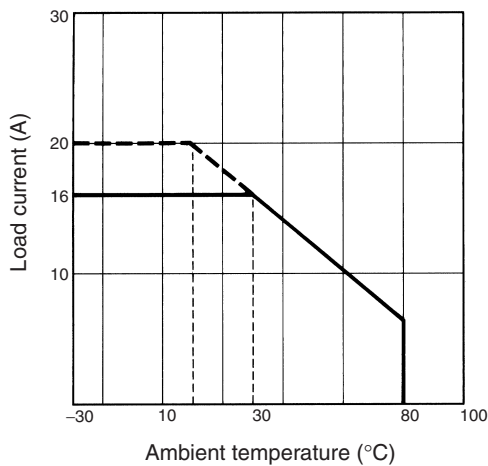

G3PA-430B-VD, G3PA-430B-VD-2

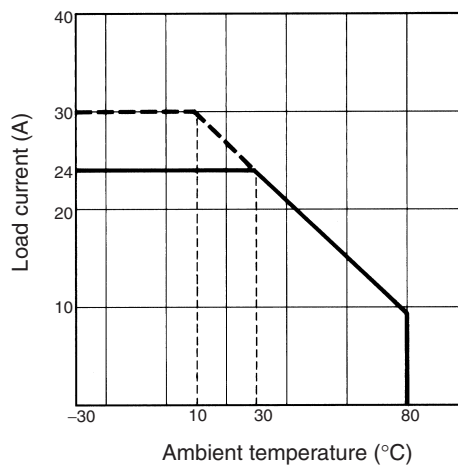

G3PA-450B-VD-2

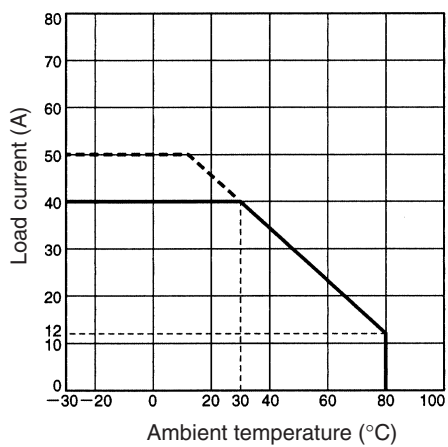

Inrush Current Resistivity

One cycle, non-repetitive (Keep the inrush current to half the rated value if it occurs repetitively.)

G3PA-210B(L)-VD

**G3PA-220B(L)-VD, G3PA-420B-VD,
G3PA-420B-VD-2**

**G3PA-240B(L)-VD/260B(L)-VD,
G3PA-430B-VD, G3PA-430B-VD-2,
G3PA-450B-VD-2**

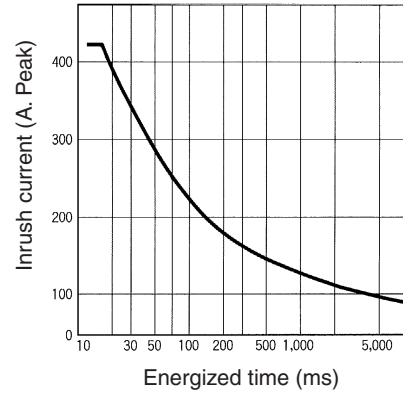
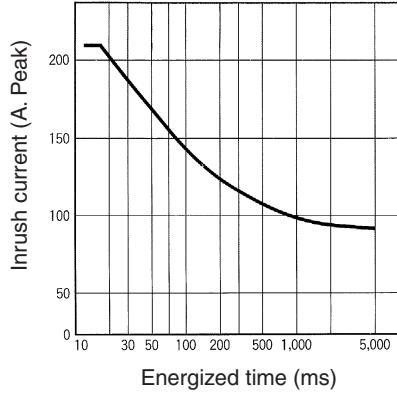
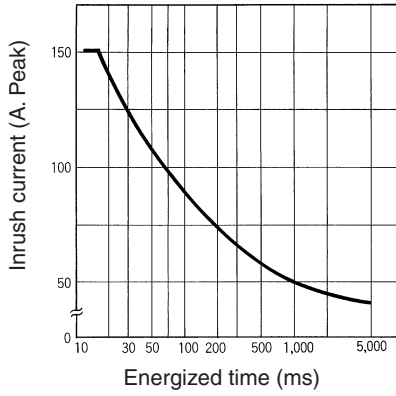

Dimensions

Note: All units are in millimeters unless otherwise indicated.

G3PA-210B(L)-VD

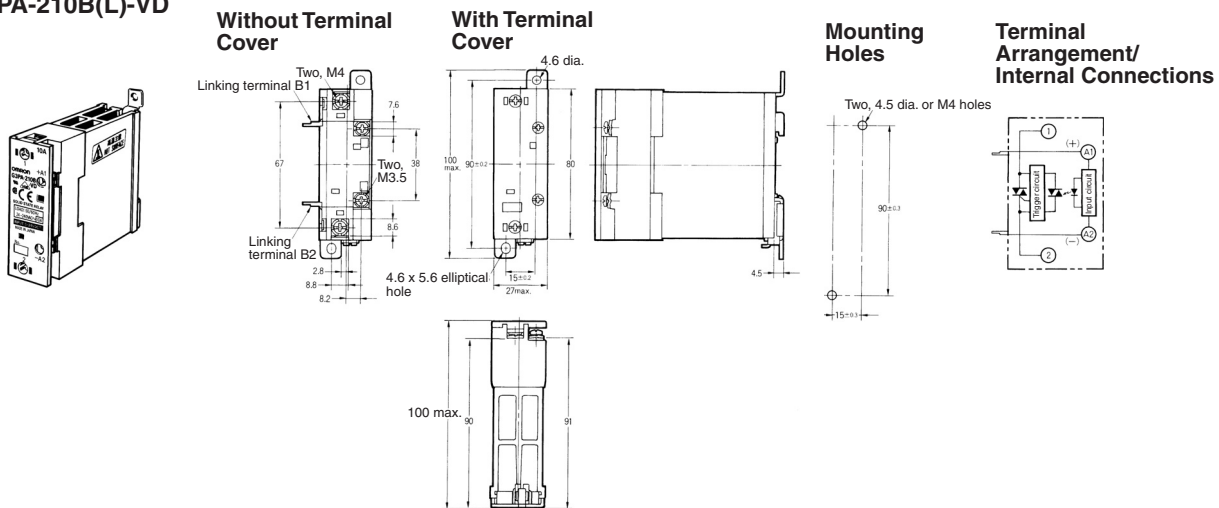

G3PA-220B(L)-VD

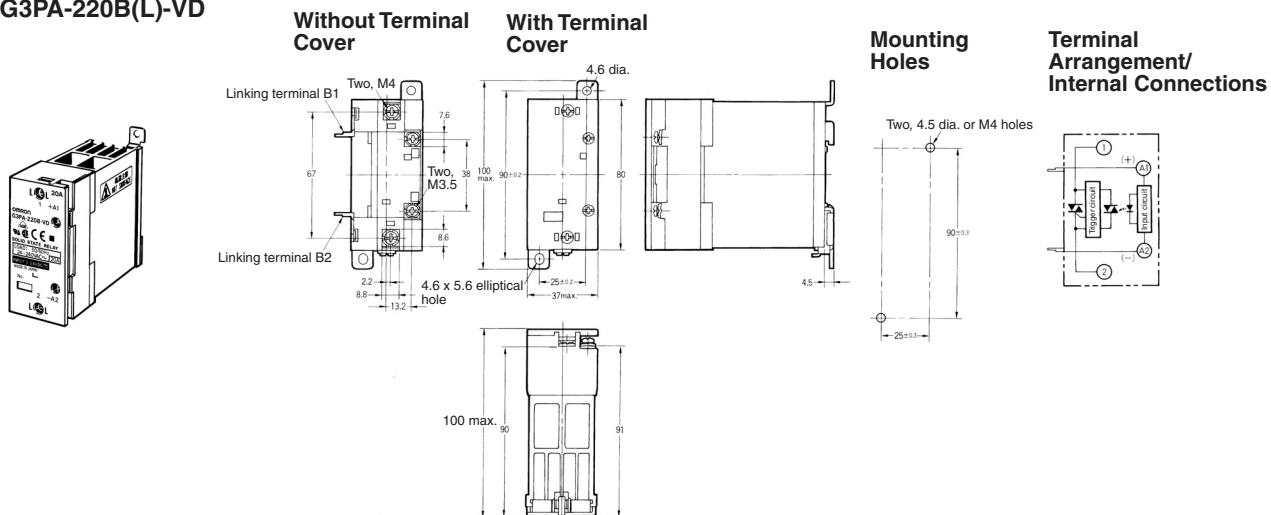

G3PA-240B(L)-VD

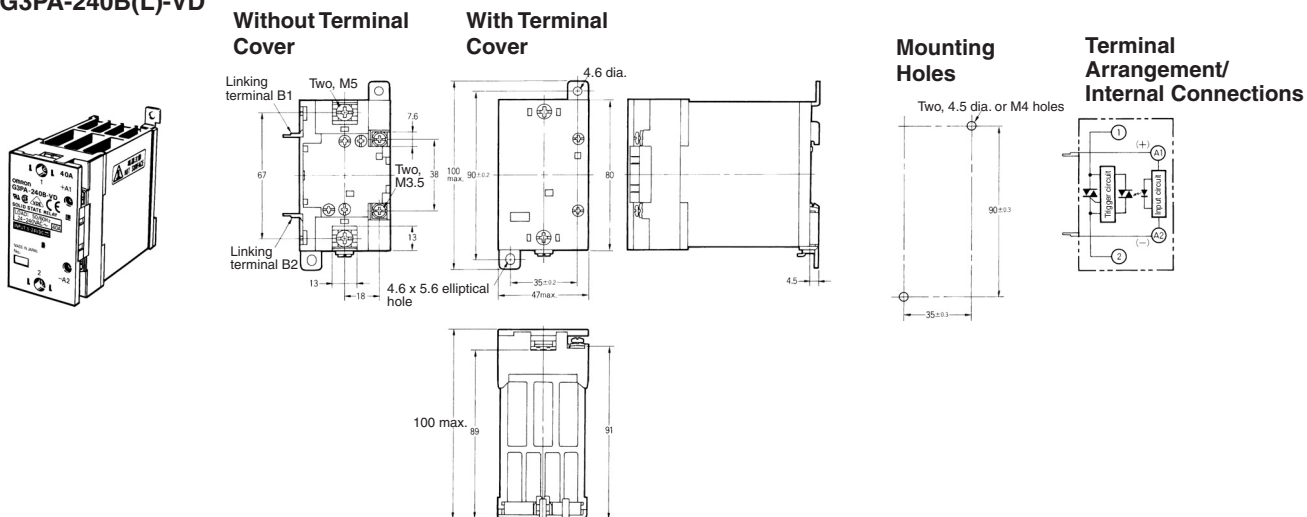

**G3PA-260B(L)-VD
G3PA-450B-VD-2**

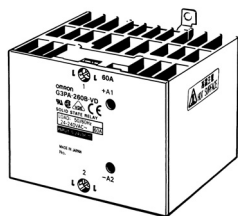

With Terminal Cover

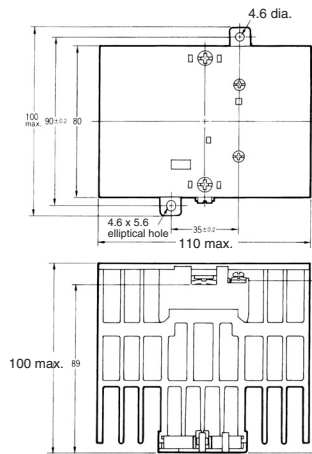

Without Terminal Cover

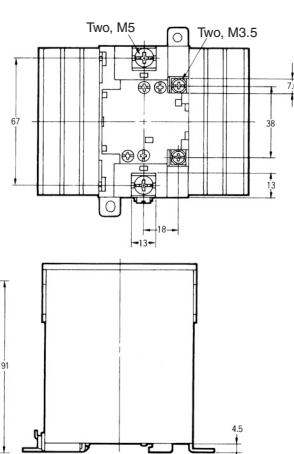

Mounting Holes

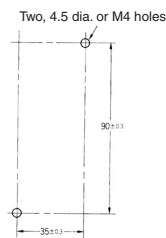

**Terminal Arrangement/
Internal Connections**

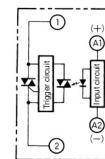

G3PA-420B-VD, G3PA-420B-VD-2

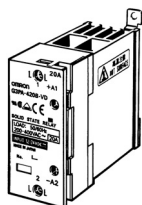

Without Terminal Cover

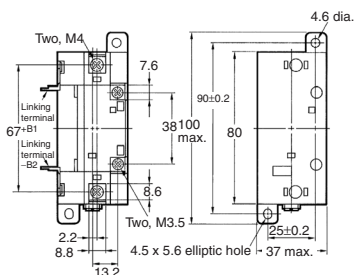

With Terminal Cover

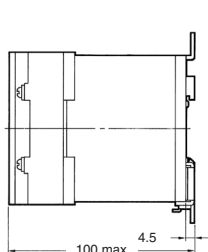

Mounting Holes

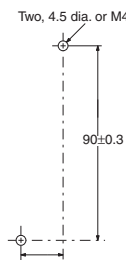

**Terminal Arrangement/
Internal Connections**

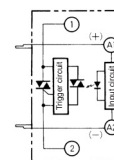

G3PA-430B-VD, G3PA-430B-VD-2

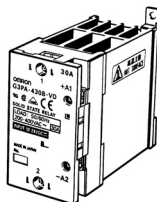

Without Terminal Cover

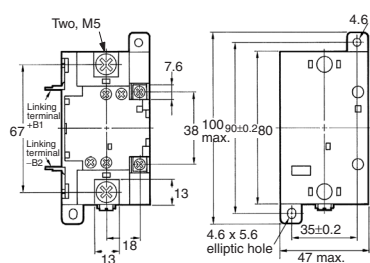

With Terminal Cover

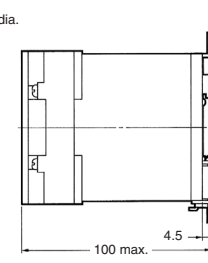

Mounting Holes

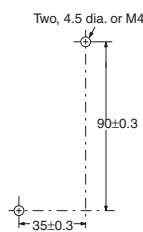

**Terminal Arrangement/
Internal Connections**

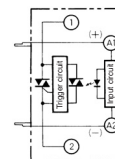

Safety Precautions

■ Precautions for Correct Use

Please observe the following precautions to prevent failure to operate, malfunction, or undesirable effect on product performance.

Load Connection

For an AC load, use a power supply rated at 50 or 60 Hz. The maximum operating frequency is 10 Hz. The G3PA-(VD) has a built-in varistor for overvoltage protection.

At a low applied voltage, such as 24 VAC, the load current is not fully supplied. When the Unit is switched ON, the voltage required to power the Unit deprives the output signal of the necessary voltage level and thus creates loss time. The lower the load voltage is, the greater the loss time is. This condition, however, will not create any serious problems.

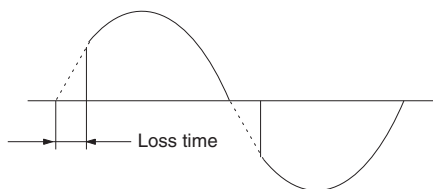

For a DC or L load, a diode should be connected in parallel the load to absorb the counter electromotive force of the load.

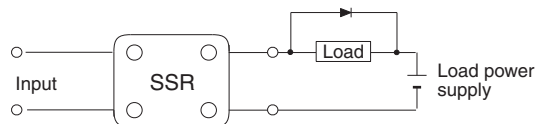

Noise Terminal Voltage according to EN55011

The G3PA-(VD) complies with EN55011 standards when a capacitor is connected to the load power supply as shown in the following circuit diagram.

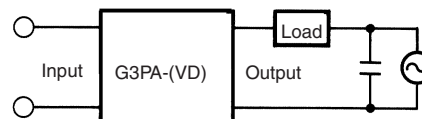

Recommended Capacitor: 1 μ F, 250 VAC

Mounting

When attaching a heat sink to the G3PA-(VD), in order to facilitate heat dissipation, apply silicone grease or equivalent heat-conductive grease on the heat sink. (Toshiba Silicone, Shinetsu Silicone, etc.)

Tighten the mounting screws of the heat sink with a torque of 0.78 to 0.98 N•m.

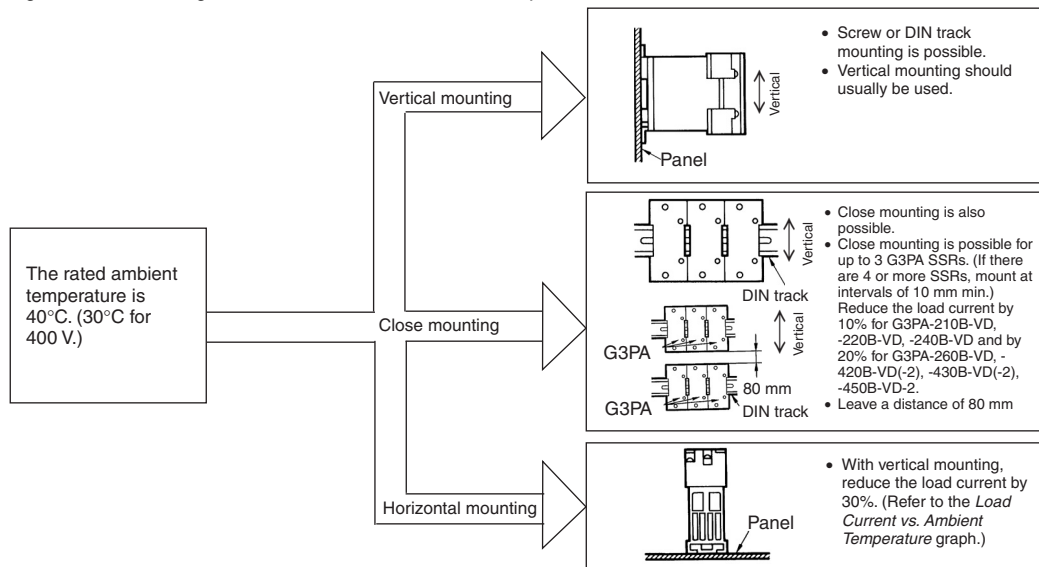

Note: Leave a distance of 60 mm min. between SSRs and ducts (especially above the SSR).

Close Mounting SSR Mounting Pitch

Panel Mounting

(At a rated ambient temperature of 40°C).

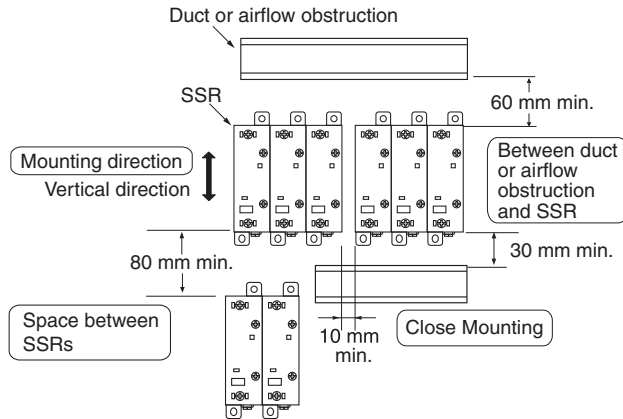

An SSR uses a semiconductor in the output element. This causes the temperature inside the control panel to increase due to heating resulting from the passage of electrical current through the load. To restrict heating, attach a fan to the ventilation outlet or air inlet of the control panel. This will reduce the ambient temperature of the SSRs and thus increase reliability. (Generally, each 10°C reduction in temperature will double the expected life.)

Load current (A)	10 A	20 A	30 A	40 A	60 A
Required number of fans per SSR	0.16	0.31	0.47	0.62	0.93

Example: For 10 SSRs with load currents of 20 A,

$$0.31 \times 10 = 3.1$$

Thus, 4 fans would be required.

Size of fans: 92 mm², Air volume: 0.7 m³/min,

Ambient temperature of control panel: 30°C

If there are instruments that generate heat in the control panel other than SSRs, additional ventilation will be required.

Relationship between SSRs and Ducts

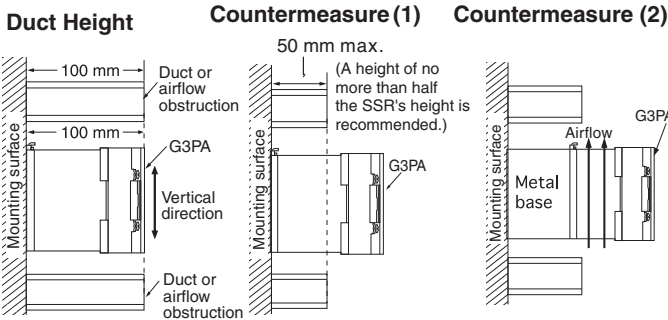

Do not surround the SSR with ducts, otherwise the heat radiation of the SSR will be adversely affected.

Use short ducts.

If the ducts cannot be shortened, place the SSR on a metal base so that it is not surrounded by the ducts.

Ventilation

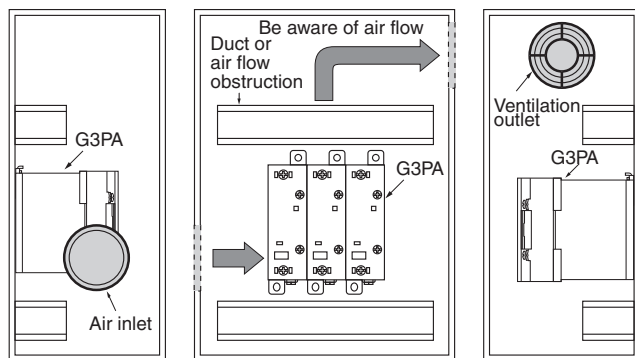

If the air inlet or air outlet has a filter, clean the filter regularly to prevent it from clogging and ensure an efficient flow of air.

Do not locate any objects around the air inlet or air outlet, otherwise the objects may obstruct the proper ventilation of the control panel.

A heat exchanger, if used, should be located in front of the SSR Units to ensure the efficiency of the heat exchanger.

Please reduce the ambient temperature of SSRs.

The rated load current of an SSR is measured at an ambient temperature of 25 or 40°C.

Omron Electronic Components, LLC

Terms and Conditions of Sales

I. GENERAL

- Definitions:** The words used herein are defined as follows.
 - Terms:** These terms and conditions
 - Seller:** Omron Electronic Components LLC and its subsidiaries
 - Buyer:** The buyer of Products, including any end user in section III through VI
 - Products:** Products and/or services of Seller
 - Including:** Including without limitation
- Offer; Acceptance:** These Terms are deemed part of all quotations, acknowledgments, invoices, purchase orders and other documents, whether electronic or in writing, relating to the sale of Products by Seller. Seller hereby objects to any Terms proposed in Buyer's purchase order or other documents which are inconsistent with, or in addition to, these Terms.
- Distributor:** Any distributor shall inform its customer of the contents after and including section III of these Terms.

II. SALES

- Prices; Payment:** All prices stated are current, subject to change without notice by Seller. Buyer agrees to pay the price in effect at the time the purchase order is accepted by Seller. Payments for Products received are due net 30 days unless otherwise stated in the invoice. Buyer shall have no right to set off any amounts against the amount owing in respect of this invoice.
- Discounts:** Cash discounts, if any, will apply only on the net amount of invoices sent to Buyer after deducting transportation charges, taxes and duties, and will be allowed only if (a) the invoice is paid according to Seller's payment terms and (b) Buyer has no past due amounts owing to Seller.
- Interest:** Seller, at its option, may charge Buyer 1.5% interest per month or the maximum legal rate, whichever is less, on any balance not paid within the stated terms.
- Orders:** Seller will accept no order less than 200 U.S. dollars net billing.
- Currencies:** If the prices quoted herein are in a currency other than U.S. dollars, Buyer shall make remittance to Seller at the then current exchange rate most favorable to Seller; provided that if remittance is not made when due, Buyer will convert the amount to U.S. dollars at the then current exchange rate most favorable to Seller available during the period between the due date and the date remittance is actually made.
- Governmental Approvals:** Buyer shall be responsible for all costs involved in obtaining any government approvals regarding the importation or sale of the Products.
- Taxes:** All taxes, duties and other governmental charges (other than general real property and income taxes), including any interest or penalties thereon, imposed directly or indirectly on Seller or required to be collected directly or indirectly by Seller for the manufacture, production, sale, delivery, importation, consumption or use of the Products sold hereunder (including customs duties and sales, excise, use, turnover and license taxes) shall be charged to and remitted by Buyer to Seller.
- Financial:** If the financial position of Buyer at any time becomes unsatisfactory to Seller, Seller reserves the right to stop shipments or require satisfactory security or payment in advance. If Buyer fails to make payment or otherwise comply with these Terms or any related agreement, Seller may (without liability and in addition to other remedies) cancel any unshipped portion of Products sold hereunder and stop any Products in transit until Buyer pays all amounts, including amounts payable hereunder, whether or not then due, which are owing to it by Buyer. Buyer shall in any event remain liable for all unpaid accounts.
- Cancellation; Etc:** Orders are not subject to rescheduling or cancellation unless Buyer indemnifies Seller fully against all costs or expenses arising in connection therewith.
- Force Majeure:** Seller shall not be liable for any delay or failure in delivery resulting from causes beyond its control, including earthquakes, fires, floods, strikes or other labor disputes, shortage of labor or materials, accidents to machinery, acts of sabotage, riots, delay in or lack of transportation or the requirements of any government authority.
- Shipping; Delivery:** Unless otherwise expressly agreed in writing by Seller:
 - All sales and shipments of Products shall be FOB shipping point (unless otherwise stated in writing by Seller), at which point title to and all risk of loss of the Products shall pass from Seller to Buyer, provided that Seller shall retain a security interest in the Products until the full purchase price is paid by Buyer;
 - Delivery and shipping dates are estimates only; and
 - Seller will package Products as it deems proper for protection against normal handling and extra charges apply to special conditions.
- Claims:** Any claim by Buyer against Seller for shortage or damage to the Products occurring before delivery to the carrier or any claim related to pricing or other charges must be presented in detail in writing to Seller within 30 days of receipt of shipment.

III. PRECAUTIONS

- Suitability:** IT IS THE BUYER'S SOLE RESPONSIBILITY TO ENSURE THAT ANY OMRON PRODUCT IS FIT AND SUFFICIENT FOR USE IN A MOTORIZED VEHICLE APPLICATION. BUYER SHALL BE SOLELY RESPONSIBLE FOR DETERMINING APPROPRIATENESS OF THE PARTICULAR PRODUCT WITH RESPECT TO THE BUYER'S APPLICATION INCLUDING (A) ELECTRICAL OR ELECTRONIC COMPONENTS, (B) CIRCUITS, (C) SYSTEM ASSEMBLIES, (D) END PRODUCT, (E) SYSTEM, (F) MATERIALS OR SUBSTANCES OR (G) OPERATING ENVIRONMENT. Buyer acknowledges that it alone has determined that the Products will meet their requirements of the intended use in all cases. Buyer must know and observe all prohibitions of use applicable to the Product/s.
- Use with Attention:** The followings are some examples of applications for which particular attention must be given. This is not intended to be an exhaustive list of all possible use of any Product, nor to imply that any use listed may be suitable for any Product:
 - Outdoor use, use involving potential chemical contamination or electrical interference.

- Use in consumer Products or any use in significant quantities.
 - Energy control systems, combustion systems, railroad systems, aviation systems, medical equipment, amusement machines, vehicles, safety equipment, and installations subject to separate industry or government regulations.
 - Systems, machines, and equipment that could present a risk to life or property.
- Prohibited Use:** NEVER USE THE PRODUCT FOR AN APPLICATION INVOLVING SERIOUS RISK TO LIFE OR PROPERTY WITHOUT ENSURING THAT THE SYSTEM AS A WHOLE HAS BEEN DESIGNED TO ADDRESS THE RISKS, AND THAT THE PRODUCT IS PROPERLY RATED AND INSTALLED FOR THE INTENDED USE WITHIN THE OVERALL EQUIPMENT OR SYSTEM.
 - Motorized Vehicle Application:** USE OF ANY PRODUCT/S FOR A MOTORIZED VEHICLE APPLICATION MUST BE EXPRESSLY STATED IN THE SPECIFICATION BY SELLER.
 - Programmable Products:** Seller shall not be responsible for the Buyer's programming of a programmable Product.

IV. WARRANTY AND LIMITATION

- Warranty:** Seller's exclusive warranty is that the Products will be free from defects in materials and workmanship for a period of twelve months from the date of sale by Seller (or such other period expressed in writing by Seller). SELLER MAKES NO WARRANTY OR REPRESENTATION, EXPRESS OR IMPLIED, ABOUT ALL OTHER WARRANTIES, NON-INFRINGEMENT, MERCHANTABILITY OR FITNESS FOR A PARTICULAR PURPOSE OF THE PRODUCTS.
- Buyer Remedy:** Seller's sole obligation hereunder shall be to replace (in the form originally shipped with Buyer responsible for labor charges for removal or replacement thereof) the non-complying Product or, at Seller's election, to repay or credit Buyer an amount equal to the purchase price of the Product; provided that there shall be no liability for Seller or its affiliates unless Seller's analysis confirms that the Products were correctly handled, stored, installed and maintained and not subject to contamination, abuse, misuse or inappropriate modification. Return of any Products by Buyer must be approved in writing by Seller before shipment.
- Limitation on Liability:** SELLER AND ITS AFFILIATES SHALL NOT BE LIABLE FOR SPECIAL, INDIRECT, INCIDENTAL OR CONSEQUENTIAL DAMAGES, LOSS OF PROFITS OR PRODUCTION OR COMMERCIAL LOSS IN ANY WAY CONNECTED WITH THE PRODUCTS, WHETHER SUCH CLAIM IS BASED IN CONTRACT, WARRANTY, NEGLIGENCE OR STRICT LIABILITY. FURTHER, IN NO EVENT SHALL LIABILITY OF SELLER OR ITS AFFILIATES EXCEED THE INDIVIDUAL PRICE OF THE PRODUCT ON WHICH LIABILITY IS ASSERTED.
- Indemnities:** Buyer shall indemnify and hold harmless Seller, its affiliates and its employees from and against all liabilities, losses, claims, costs and expenses (including attorney's fees and expenses) related to any claim, investigation, litigation or proceeding (whether or not Seller is a party) which arises or is alleged to arise from Buyer's acts or omissions under these Terms or in any way with respect to the Products.

V. INFORMATION; ETC.

- Intellectual Property:** The intellectual property embodied in the Products is the exclusive property of Seller and its affiliates and Buyer shall not attempt to duplicate it in any way without the written permission of Seller. Buyer (at its own expense) shall indemnify and hold harmless Seller and defend or settle any action brought against Seller to the extent that it is based on a claim that any Product made to Buyer specifications infringed intellectual property rights of another party.
- Property; Confidentiality:** Notwithstanding any charges to Buyer for engineering or tooling, all engineering and tooling shall remain the exclusive property of Seller. All information and materials supplied by Seller to Buyer relating to the Products are confidential and proprietary, and Buyer shall limit distribution thereof to its trusted employees and strictly prevent disclosure to any third party.
- Performance Data:** Performance data is provided as a guide in determining suitability and does not constitute a warranty. It may represent the result of Seller's test conditions, and the users must correlate it to actual application requirements.
- Change In Specifications:** Product specifications and descriptions may be changed at any time based on improvements or other reasons. It is Seller's practice to change part numbers when published ratings or features are changed, or when significant engineering changes are made. However, some specifications of the Product may be changed without any notice.
- Errors And Omissions:** The information on Seller's website or in other documentation has been carefully checked and is believed to be accurate; however, no responsibility is assumed for clerical, typographical or proofreading errors or omissions.
- Export Controls:** Buyer shall comply with all applicable laws, regulations and licenses regarding (a) export of the Products or information provided by Seller; (b) sale of Products to forbidden or other proscribed persons or organizations; (c) disclosure to non-citizens of regulated technology or information.

VI. MISCELLANEOUS

- Waiver:** No failure or delay by Seller in exercising any right and no course of dealing between Buyer and Seller shall operate as a waiver of rights by Seller.
- Assignment:** Buyer may not assign its rights hereunder without Seller's written consent.
- Law:** These Terms are governed by Illinois law (without regard to conflict of laws). Federal and state courts in Cook County, Illinois have exclusive jurisdiction for any dispute hereunder.
- Amendment:** These Terms constitute the entire agreement between Buyer and Seller relating to the Products, and no provision may be changed or waived unless in writing signed by the parties.
- Severability:** If any provision hereof is rendered ineffective or invalid, such provision shall not invalidate any other provision.

Certain Precautions on Specifications and Use

1. **Suitability for Use.** Seller shall not be responsible for conformity with any standards, codes or regulations which apply to the combination of the Product in Buyer's application or use of the Product. At Buyer's request, Seller will provide applicable third party certification documents identifying ratings and limitations of use which apply to the Product. This information by itself is not sufficient for a complete determination of the suitability of the Product in combination with the end product, machine, system, or other application or use. Buyer shall be solely responsible for determining appropriateness of the particular Product with respect to Buyer's application, product or system. Buyer shall take application responsibility in all cases but the following is a non-exhaustive list of applications for which particular attention must be given:
 - (i) Outdoor use, uses involving potential chemical contamination or electrical interference, or conditions or uses not described in this document.
 - (ii) Energy control systems, combustion systems, railroad systems, aviation systems, medical equipment, amusement machines, vehicles, safety equipment, and installations subject to separate industry or government regulations.
 - (iii) Use in consumer products or any use in significant quantities.
 - (iv) Systems, machines and equipment that could present a risk to life or property. Please know and observe all prohibitions of use applicable to this product.

NEVER USE THE PRODUCT FOR AN APPLICATION INVOLVING SERIOUS RISK TO LIFE OR PROPERTY WITHOUT ENSURING THAT THE SYSTEM AS A WHOLE HAS BEEN DESIGNED TO ADDRESS THE RISKS, AND THAT THE OMRON PRODUCT IS PROPERLY RATED AND INSTALLED FOR THE INTENDED USE WITHIN THE OVERALL EQUIPMENT OR SYSTEM.
2. **Programmable Products.** Seller shall not be responsible for the user's programming of a programmable product, or any consequence thereof.
3. **Performance Data.** Performance data given in this publication is provided as a guide for the user in determining suitability and does not constitute a warranty. It may represent the result of Seller's test conditions, and the users must correlate it to actual application requirements. Actual performance is subject to Seller's Warranty and Limitations of Liability.
4. **Change in Specifications.** Product specifications and accessories may be changed at any time based on improvements and other reasons. It is our practice to change part numbers when published ratings or features are changed, or when significant construction changes are made. However, some specifications of the Product may be changed without any notice. When in doubt, special part numbers may be assigned to fix or establish key specifications for your application. Please consult with your Seller representative at any time to confirm actual specifications of purchased Product.
5. **Errors and Omissions.** The information in this publication has been carefully checked and is believed to be accurate; however, no responsibility is assumed for clerical, typographical or proofreading errors, or omissions.
6. **RoHS Compliance.** Where indicated, our products currently comply, to the best of our knowledge as of the date of this publication, with the requirements of the European Union's Directive on the Restriction of certain Hazardous Substances ("RoHS"), although the requirements of RoHS do not take effect until July 2006. These requirements may be subject to change. Please consult our website for current information.

Complete "Terms and Conditions of Sale" for product purchase and use are on Omron's website at <http://www.components.omron.com> – under the "About Us" tab, in the Legal Matters section.

ALL DIMENSIONS SHOWN ARE IN MILLIMETERS.

To convert millimeters into inches, multiply by 0.03937. To convert grams into ounces, multiply by 0.03527.

OMRON®

**OMRON ELECTRONIC
COMPONENTS LLC**

55 E. Commerce Drive, Suite B
Schaumburg, IL 60173

847-882-2288

OMRON ON-LINE

Global - <http://www.omron.com>

USA - <http://www.components.omron.com>