

User's Guide

EXTECH INSTRUMENTS

Datalogging / Printing Anemometer + Psychrometer

Model 451181



Introduction

Congratulations on your purchase of the Extech 451181 Datalogging / Printing Anemometer + Psychrometer. This device simultaneously measures and displays Air Velocity, Temperature, Humidity, Wet Bulb Temperature, and Air Volume (CFM / CMM). The datalogger stores 2400 readings in Automatic Recording mode and 99 readings in Manual Recording mode. The Printer provides a hard copy of individual readings while the PC software permits downloading of data for use in spreadsheets, database, and other programs. This meter is shipped fully tested and calibrated and with proper use will provide years of reliable service.

Meter Description

1. Sensor plug
2. LCD Display
3. F1 through F4 softkeys
4. Keypad
5. Printer paper and paper compartment
6. AC Adapter jack
7. RS-232c TTL output jack
8. Vane air velocity sensor
9. Temperature and humidity sensor housing (must be opened before use)

The battery compartment is located on the back of the instrument. There are two (2) tripod mounts; one on the rear of the meter and one on the rear of the vane handle.

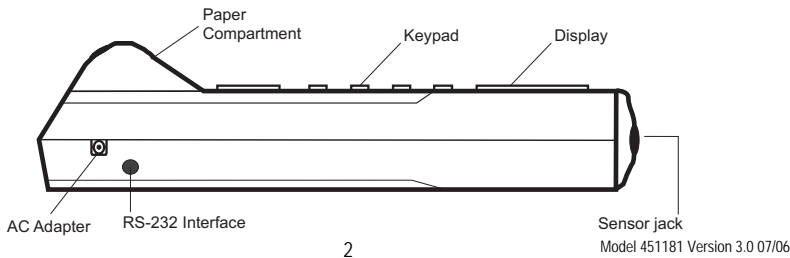
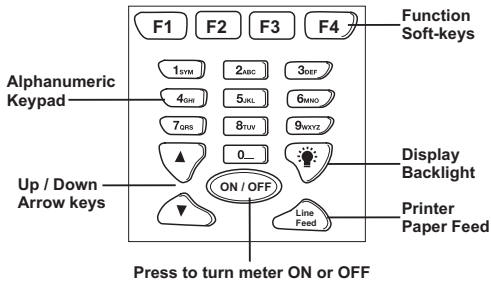
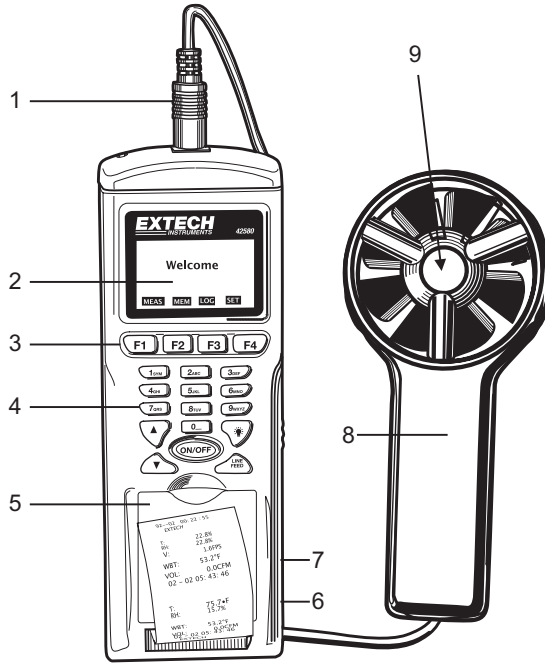

Operation

Press the ON/OFF button to power the meter. The WELCOME screen will appear along with four softkey selections (F1 through F4):

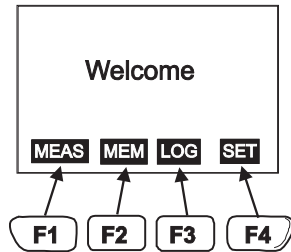

Setup

The Setup Screens provides access to the LCD Contrast, Printer Contrast, Auto Power-Off time, Auto Power-Off Enable/Disable, Calendar Clock, and View configuration.

Setup Screen 1

1. Press **F4 SET** from the WELCOME screen to access the 1st setup screen.
2. Use the **▲** or **▼** arrow keys to move the **|** cursor to the desired position.
3. The programmable parameters for the first setup screen are as follows:

- **LCD Cont:** Adjust the LCD contrast (1-5) using the numeric keypad.
- **Prn Cont:** Adjust the print contrast (1-9) using the numeric keypad.
- **Auto Power Off Time:** Set the time period that the instrument will wait before automatically shutting down (1 to 20 minutes)
- **Auto Power Off Enable/Disable:** With the Auto Power Off disabled, the meter will not automatically shut down.

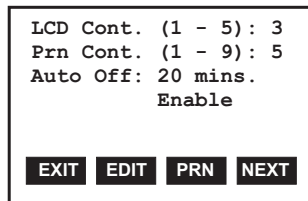

MAIN SETUP SCREEN 1

4. Press **F1 EXIT** to exit the setup mode.
5. Press **F4 NEXT** to access the second setup screen for real time clock setup.

Setup Screen 2

1. Use the **▲** or **▼** arrow keys to highlight the desired text to edit.
2. The order of DAY (DD), MONTH (MM), and YEAR (YY) can be edited by highlighting and pressing **F2 EDIT**.
3. The Date and Time can be set by highlighting with the **▲** or **▼** arrow keys and programming with the alphanumeric keys.
4. The SET ID can be set to ENABLE if a custom ID will be used. Use the **▲** or **▼** arrow keys to highlight and **F2 EDIT** to change the setting.
5. Press **F4 NEXT** to access the third setup screen's ITEM list.

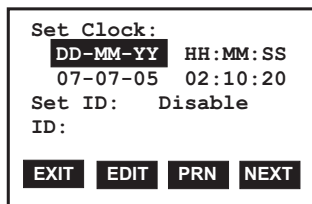

MAIN SETUP SCREEN 2

Setup Screen 3

1. Measurement parameters with a check mark will be included on the measurement screen. Items with an 'X' will not be shown in the measurement screen. Use the ▲ or ▼ arrow keys to select an item and then use **F2 EDIT** to change from 'X' to a check mark or from a check mark to an 'X'.
2. The unit of measure shown next to each measurement parameter can also be altered by first selecting with the ▲ or ▼ arrow keys and then adjusting using **F2 EDIT**.

Select item		
V	✓	FPM
T	✓	F
RH	✓	%
WBT	x	F
VOL	✓	CFM
EXIT	EDIT	PRN NEXT

MAIN SETUP SCREEN 3

Measurement Procedure

Air Velocity, Temperature, Relative Humidity, and Wet Bulb Measurements

1. Turn the instrument ON by pressing the ON/OFF button.
2. Turn the temperature/humidity sensor cover (located at the center of the vane) to the OPEN position. This will expose the sensors to the air flow in order to provide temperature, humidity, and wet bulb readings (see diagram).
3. Press **F1 MEAS** to enter the measurement mode.
4. Hold the vane sensor in the stream of air with the vane's temperature and humidity sensors facing the oncoming air stream.
5. Read the Air Velocity, Temperature, Relative Humidity, Wet Bulb Temperature, and Air Volume readings on the LCD (see diagram).
6. Use **F1 EXIT** to leave the measurement window.
7. Use **F2 INPUT** to begin programming the area of the duct, or other enclosure, necessary for Air Volume (CFM / CMM) measurements. Refer to the separate section on Air Volume measurements.
8. Use **F4 PRN** to print the measurement data (see next paragraph).
9. Move the rotating sensor cover to the closed position when the meter is not in use. See diagram above.

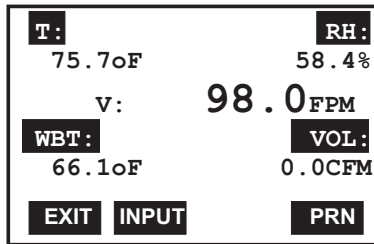
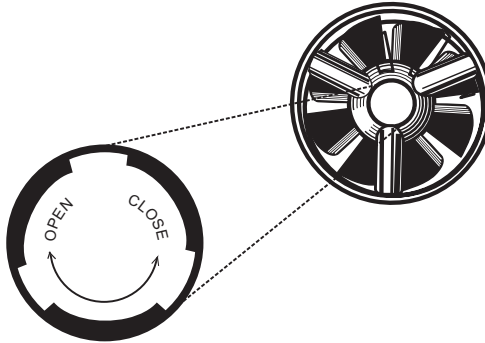

MEASUREMENT (MEAS) SCREEN

Printing Measurements

1. Perform the Measurement procedure as described above.
2. Press **F4 PRN** and answer YES when prompted.
3. The instrument will print all the displayed data with date/time stamps. See sample printout at right.
4. Press the LINE FEED button to feed the paper.

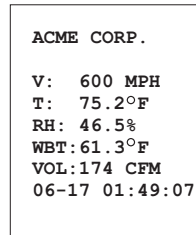

SAMPLE PRINTOUT

Air Volume Measurements

Air Volume (CFM / MM) measurements require that the area of the duct or other enclosure be known. The meter can calculate the area of rectangular and circular ducts or the user can calculate the area and enter it manually. See details below:

1. Measure (in inches) the diameter of a circular duct or the length/width of a rectangular duct. Optional: Calculate the duct area.
2. Press **F1 MEAS** from the WELCOME screen.
3. Press **F2 INPUT** softkey.
4. If the area (in square inches) has been manually calculated, press AREA and enter the value using the numeric keypad; Press **ENTER**, then proceed to step 6. Otherwise continue with step 5.
5. For rectangular ducts, press **LxW** (length x width) and enter the length (in inches) of the duct (using the numeric keypad). Press **ENTER** and do the same for the width. Press **ENTER** after the width is programmed. For circular ducts, press the **D** (diameter) key. Enter the duct's diameter (in inches) using the numeric keypad and then press **ENTER**.
6. Take an air velocity measurement as previously described.
7. Read the CFM or CMM Air Volume measurement on the LCD.

Manual Datalogging Mode

The Model 451181 has two datalogging modes, **MEM** Manual Datalogging (99 records maximum) and Automatic Datalogging **LOG** (2400 records maximum). This section covers Manual Mode and the following section covers Automatic Mode.

Manual Datalogging basics

To take a reading and store it in memory:

1. Press **F2 MEM** from the WELCOME screen.
2. Use the arrow buttons to select a memory location (1 through 99) shown in the upper left hand corner of the LCD.
3. Press **F2 MEAS** and then take a measurement.
4. At any time during the measurement, press **F4 SAVE** or **F1 ABORT**.

Manual Datalogging Display screens 1 and 2

Manual mode uses two display screens as shown below. Each screen has its own softkeys. Other than the softkey differences, the screens are identical, showing the measurement results.

To get to the 1st memory screen press **F2 MEM** from the WELCOME screen. The first Memory display screen will appear with the memory location number (1 through 99) shown in the upper left hand corner.

Softkeys for Memory Screen 1

- **F1 EXIT**: Press to return to the WELCOME screen
- **F2 MEAS**: Press to take a measurement. **ABORT (F1)** and **SAVE (F4)** keys will be active. Press **SAVE** to store the current reading in the selected memory location. Press **ABORT** to return to the previous screen.
- **F3 EDIT**: Press to begin customizing the header in the current memory location. The **ABORT (F1)**, **CLR (F2)**, **BACK (F3)**, and **ENTER (F4)** softkeys will be active. Customizing a header is explained in detail in the next section.
- **F4 NEXT**: Press to access the second Memory display screen. Memory screen two is identical to screen 1 except that screen 2 has **F1 EXIT**, **F2 CLR** (clear), **F3 PRN** (Print), and **F4 BACK** softkeys described below.

01:	07-06	05:42:50
V:	98.0FPM	
T:	82.01oF	
RH:	62.7%	
WBT:	72.2oF	
VOL:	0.0CFM	
EXIT	MEAS	EDIT NEXT

MEMORY (MEM) SCREEN 1

Softkeys for Memory Screen 2

- **F1 EXIT**: Press to return to the WELCOME screen
- **F2 CLR**: Press to clear the header for the selected memory location.
- **F3 PRN**: Press to print the data in the current memory location.
- **F4 BACK**: Press to return to memory screen 1.

01:	07-06	05:42:50
V:	98.0FPM	
T:	82.01oF	
RH:	62.7%	
WBT:	72.2oF	
VOL:	0.0CFM	
EXIT	CLR	PRN BACK

MEMORY (MEM) SCREEN 2

Customizing a Memory Location Header

Using the **F3 EDIT** softkey in Memory screen 1, as described above, allows the user to customize the header in the currently selected memory location.

1. Use the **▲** or **▼** arrow keys to step forward and backward in the header.
2. Use the **BACK** softkey to step backward and erase characters while stepping.
3. Use the alphanumeric keypad to compose a header. For example, press the '2' key and a window with the characters related to the '2' key will appear (namely, 2abcABC as shown in the diagram). Then use the '2' key again to scroll through the character list. When the desired character is highlighted the meter will automatically place that character in the header.
4. **F2 CLR** is used to erase the header.
5. **F4 ENTER** is used to save the header.

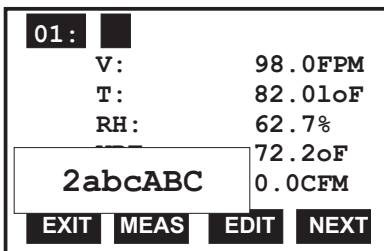

HEADER EDITING

Viewing Stored Readings

1. From the WELCOME screen, press **F2 MEM**
2. Use the **▲** or **▼** arrow keys to scroll through the memory locations that contain the stored data.
3. Press **F1 EXIT** to return to the WELCOME screen.

Printing Stored Data

Proceed to the second memory screen as previously described and use **F3 PRN** to print a data record. Use the **▲** or **▼** arrow keys to select the desired data location (0- to 99) to print.

Erasing Data

From the second memory display screen (discussed earlier), press **F2 CLR** softkey. Answer **YES** when prompted to erase ALL recorded readings. Press **NO** to abort the clearing process.

Automatic Datalogging Mode

In the Automatic Datalogging mode the Model 451181 can automatically measure and store 2400 readings at a programmed sample rate. To begin, press **F3 LOG** from the WELCOME display to access LOG screens 1 and 2:

LOG SCREEN 1

F1 EXIT: Press to return to the WELCOME screen

F2 START: Press to begin automatic Datalogging at the pre-set sampling interval. Datalogging will begin at the date/ time programmed in the SETUP mode (see below).

F3 SET: Setup mode (explained in detail in the following section).

F4 NEXT: Advances to LOG SCREEN 2 described below:

LOG SCREEN 2

F1 P-PG: Access Previous Page (previous 100 stored readings)

F2 N-PG: Access Next Page (next 100 stored readings)

F3 PRN: Print page

F4 BACK: Return to LOG SCREEN 1

0001:	07-06	05:42:50
V:		98.0FPM
T:		82.0loF
RH:		62.7%
WBT:		72.2oF
VOL:		0.0CFM
<div style="display: flex; justify-content: space-around;"> P-PG N-PG PRN BACK </div>		

LOG SCREEN 2

0001:	07-06	05:42:50
V:		98.0FPM
T:		82.0loF
RH:		62.7%
WBT:		72.2oF
VOL:		0.0CFM
<div style="display: flex; justify-content: space-around;"> EXIT START SET NEXT </div>		

LOG SCREEN 1

Automatic Datalogging SETUP mode

As mentioned in Softkey Group 1 above, the F3 SET selection allows the user to configure the datalogger for the following parameters:

BEGIN: Calendar date when datalogging will automatically begin

START: Time of day that datalogging will begin

END: Calendar date when datalogging will end

SUSPEND: Time of day that datalogging will cease each day

RATE: Sampling interval (time between recorded readings)

EXPECT: Total number of readings (2400)

REMAIN: Memory locations remaining

Begin:	01-01-05
Start:	00:00:01
End:	02-02-05
Suspend:	23:59:59
Rate:	15 secs
Expect:	2400 Points
Remain:	2393 Points
<div style="display: flex; justify-content: space-around;"> EXIT EDIT VIEW NEXT </div>	

AUTO DATALOGGER SETUP 1

The two SETUP screens are identical but for the softkey differences (see diagrams). The softkey functions for both SETUP screens are as follows:

EXIT: Returns to WELCOME screen.

EDIT: Select display field for editing.

VIEW: Calls up the stored readings log.

NEXT: Switches to SETUP screen 2.

START: Activates the datalogger

CLR: Erases all readings stores in the automatic datalogger memory.

PRN: Prints the datalogger memory record

BACK: Switches to the SETUP screen 1.

Begin:	01-01-05
Start:	00:00:01
End:	02-02-05
Suspend:	23:59:59
Rate:	15 secs
Expect:	2400 Points
Remain:	2393 Points
<div style="display: flex; justify-content: space-around;"> START CLR PRN BACK </div>	

AUTO DATALOGGER SETUP 2

To edit the fields in the datalogger display screens:

1. Use the up and down ▲ or ▼ arrow keys to scroll through the parameters.
2. When a parameter is highlighted, use **F2 EDIT** to open it for editing.
3. Use the alphanumeric keypad to edit the parameter.
4. Press **F4 ENTER** to save changes. Press **F1 ABORT** to cancel changes.
5. Press the **F1 EXIT** to return to the SETUP screen.

Recording Data in the Automatic Datalogging Mode

1. After configuring the datalogger using the SETUP screens as described above, place the meter in position to take readings (a tripod mount is provided on the rear of the instrument for convenience).
2. Press **F3 LOG** from the WELCOME screen and then press **F2 START**.
3. Recording will begin on the date and time programmed at the BEGIN and START lines in the SETUP screen.
4. The Datalogger will record everyday from the START time to the SUSPEND time. The last day that datalogging will take place is the date programmed in the END line.
5. When the logging begins, the screen should indicate LOGGING...
6. If the screen does not indicate logging at the programmed start time, make sure the START key was pressed. Also check the section below entitled "Automatic Datalogging START and END date considerations" for troubleshooting.
7. To stop logging before the programmed SUSPEND time, press **F1 STOP**.
8. To view the data recorded, press **F4 VIEW**.
9. To print data from the list, press **F3 PRN**. Press **F2** when the **PRINT?** display appears.
10. To clear (erase) the recorded data, access the LOG mode from the WELCOME screen. Select SET and then press and hold the CLR (clear) softkey until the display prompts for confirmation. Select YES to delete all records, or NO to abort the clearing process.

Automatic Datalogging START and END Date Considerations

1. If the START date is set to a date before the current date, the datalogger will start the moment the START softkey is pressed.
2. The datalogger will not start logging if the END date is set to a date before the current date.

Software

Instructions for downloading and saving data to a PC can be found on the software disk supplied with the meter.

Specifications

General Specifications

Display	Backlit Multi-function LCD
Datalogger memory	2400 readings in Auto mode (99 readings in Manual mode)
Over range indication	"-----" appears on the LCD
Printer	38mm printer includes Data/Time Stamp with each reading
PC Interface	RS-232C (TTL level)
PC Software	Windows 95/98/NT/2000/ME/XP software included
Low battery indication	Battery symbol appears on the LCD
Power supply	Four (4) 1.5V "AA" batteries or optional 6V (1000mA) adapter
Operating current	500mA (printing)
Auto Power OFF	Adjustable form 1 to 20 minutes
Operating Temperature	32 to 122°F (0 to 50°C)
Operating Humidity	90% Relative Humidity maximum
Dimensions/Weight	8.1 x 2.75 x 2.0" (208 x 70 x 53mm) / 9.2 oz. (260g) w/battery

Range Specifications

Measurement type	Range	Resolution	Accuracy
Air Velocity *	60.0 to 5000 ft/min 0.4 to 25.0 m/sec 0.8 to 50 knots 1.5 to 90 km/hr 0.9 to 56 mph	0.1 ft/min 0.1 m/sec 0.1 knots 0.1 km/hr 0.1 mph	±(3%rdg + 19.7ft/min) ±(3%rdg + 0.1m/s) ±(3%rdg + 0.2knots) ±(3%rdg + 0.4km/hr) ±(3%rdg + 0.2mph)
Temperature (°F & °C)	-4.0 to 144.0°F (-20.0 to 60.0°C)	0.1°F 0.1°C	±2°F (1°C)
Relative Humidity (RH)	0.0 to 100.0%	0.1%	±3% (10 to 90%)
Air Volume (CFM / CMM)	0.0 to 9999.9 then 10000 to 99999	0.1CFM/CMM 1CFM/CMM	±3%
Wet Bulb Temperature (WBT)	-7.6 to 158.0°F (-22.0 to 70.0°C)	0.1°F 0.1°C	Not specified

* Air Velocity Units

- FPM (feet per minute)
- KNT (knots)
- KMH (kilometer per hour)
- MPH (miles per hour)
- MPS (meters per second)

Maintenance

Cleaning

Wipe instrument with damp cloth as needed. Do not apply solvents or abrasives to the meter. Store in a cool dry place with the batteries removed.

Battery Replacement

When the batteries weaken, the LCD display will dim or go completely blank. To replace the batteries, open the rear battery compartment and insert four (4) new 1.5V 'AA' batteries with correct polarity position.

Paper roll replacement

When the paper roll is depleted, flip up the paper compartment lid, feed the paper through the paper slit, and feed the paper using the Line Feed button. Place the roll in the compartment and snap the compartment cover shut preventing the paper from falling out.

Hint: Folding the paper into a point allows the paper to "catch" a bit easier when feeding it through the slit (see diagram).

New paper rolls are available through Extech Instruments and Extech distributors.

NOTE: Thermal paper prints on only one side. Ensure paper is positioned properly as shown in diagram.

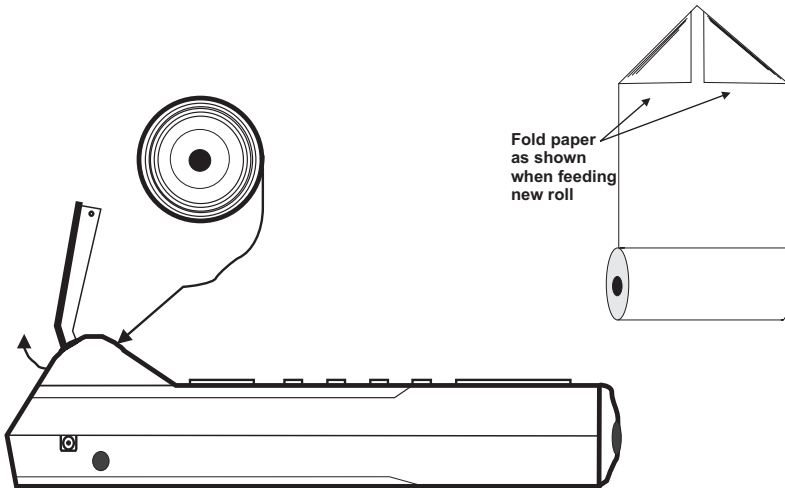

Warranty

EXTECH INSTRUMENTS CORPORATION warrants this instrument to be free of defects in parts and workmanship for one year from date of shipment (a six month limited warranty applies on sensors and cables). If it should become necessary to return the instrument for service during or beyond the warranty period, contact the Customer Service Department at (781) 890-7440 ext. 210 for authorization or visit our website at www.extech.com (click on 'Contact Extech' and go to 'Service Department' to request an RA number). A Return Authorization (RA) number must be issued before any product is returned to Extech. The sender is responsible for shipping charges, freight, insurance and proper packaging to prevent damage in transit. This warranty does not apply to defects resulting from action of the user such as misuse, improper wiring, operation outside of specification, improper maintenance or repair, or unauthorized modification. Extech specifically disclaims any implied warranties or merchantability or fitness for a specific purpose and will not be liable for any direct, indirect, incidental or consequential damages. Extech's total liability is limited to repair or replacement of the product. The warranty set forth above is inclusive and no other warranty, whether written or oral, is expressed or implied.

Calibration and Repair Services

Extech offers repair and calibration services for the products we sell. Extech also provides NIST certification for most products. Call the Customer Service Department for information on calibration services available for this product. Extech recommends that annual calibrations be performed to verify meter performance and accuracy.



Support line (781) 890-7440

Technical support: Extension 200; E-mail: support@extech.com

Repair & Returns: Extension 210; E-mail: repair@extech.com

Product specifications subject to change without notice

For the latest version of this User's Guide, Software updates, and other up-to-the-minute product information, visit our website: www.extech.com
Extech Instruments Corporation, 285 Bear Hill Rd., Wallham, MA 02451

Copyright © 2006 Extech Instruments Corporation

All rights reserved including the right of reproduction in whole or in part in any form.