

Sub-miniature Relay that Switches up to 5 A

- Sub-miniature: 20 x 10 x 10 mm (L x W x H).
- Low power consumption: 200 mW.
- Unique moving loop armature reduces relay size, magnetic interference, and contact bounce time.
- Single- and double-winding latching types also available.

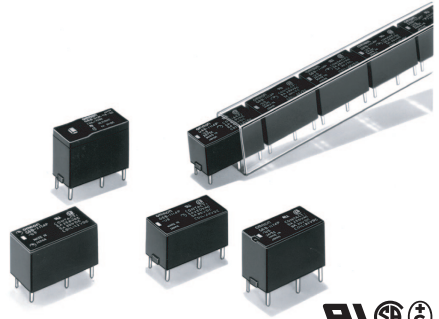

Ordering Information

Classification	Contact form	Straight PCB	Self-clinching PCB
Single-side stable	SPST-NO	G6B-1114P-US	G6B-1114C-US
	SPST-NO+SPST-NC	G6B-2114P-US	G6B-2114C-US
	DPST-NO	G6B-2214P-US	G6B-2214C-US
	DPST-NC	G6B-2014P-US	G6B-2014C-US
Single-winding latching	SPST-NO	G6BU-1114P-US	G6BU-1114C-US
Double-winding latching	SPST-NO	G6BK-1114P-US	G6BK-1114C-US
High-capacity single-side stable	SPST-NO	G6B-1174P-US	G6B-1174C-US

Note: When ordering, add the rated coil voltage to the model number.

Example: G6B-1114P-US 12 VDC



Model Number Legend

G6B - - VDC
 1 2 3 4 5 6 7

1. Relay Function

- None: Single-side stable
- U: Single-winding latching
- K: Double-winding latching

2. Contact Form

- 21: SPST-NO + SPST-NC
- 22: DPST-NO
- 20: DPST-NC
- 11: SPST-NO

3. Contact Type

- 1: Standard
- 7: High-capacity

4. Enclosure Ratings

- 4: Fully sealed

5. Terminals

- P: Straight PCB
- C: Self-clinching PCB

6. Approved Standards

- US: UL/CSA certified

7. Rated Coil Voltage

- 5, 6, 12, 24 VDC

Accessories (Order Separately)

Back Connecting Sockets

Applicable relay	Back connecting socket*
G6B(U)-1114P-US	P6B-04P
G6BK-1114P-US	P6B-06P
G6B-2114P-US	P6B-26P
G6B-1174P-US	P6B-04P

Removal Tool	P6B-Y1
Hold-down Clips	P6B-C2

*Not applicable to the self-clinching type.

Specifications

■ Coil Ratings

Single-side Stable Type

Item		SPST-NO					SPST-NO + SPST-NC, DPST-NO, DPST-NC				
Rated voltage		3 VDC	5 VDC	6 VDC	12 VDC	24 VDC	3 VDC	5 VDC	6 VDC	12 VDC	24 VDC
Rated current		67 mA	40 mA	33.3 mA	16.7 mA	8.3 mA	100 mA	60 mA	50 mA	25 v	12.5 mA
Coil resistance		45 Ω	125 Ω	180 Ω	720 Ω	2,880 Ω	30 Ω	83.3 Ω	120 Ω	480 Ω	1,920 Ω
Coil inductance (H) (ref. value)	Armature OFF	0.20	0.28	0.31	1.2	4.9	–	–	–	–	–
	Armature ON	0.18	0.26	0.28	1.1	4.1	–	–	–	–	–
Must operate voltage		70% max. of rated voltage					80% max. of rated voltage				
Must release voltage		10% min. of rated voltage									
Max. voltage		160% of rated voltage (at 23°C)					140% of rated voltage (at 23°C)				
Power consumption		Approx. 200 mW					Approx. 300 mW				

Single-winding Latching Type

Rated voltage		3 VDC	5 VDC	6 VDC	12 VDC	24 VDC
Rated current		67 mA	40 mA	33.3 mA	16.7 mA	8.3 mA
Coil resistance		45 Ω	125 Ω	180 Ω	720 Ω	2,880 Ω
Coil inductance (H) (ref. value)	Armature OFF	0.20	0.28	0.31	1.2	4.9
	Armature ON	0.18	0.26	0.28	1.1	4.1
Must operate voltage		70% max. of rated voltage				
Must release voltage		70% min. of rated voltage				
Max. voltage		160% of rated voltage (at 23°C)				
Power consumption		Approx. 200 mW				

Double-winding Latching Type

Rated voltage		3 VDC	5 VDC	6 VDC	12 VDC	24 VDC	
Set coil	Rated current	93.2 mA	56 mA	46.8 mA	23.3 mA	11.7 mA	
	Coil resistance	32.2 Ω	89.2 Ω	128.5 Ω	515 Ω	2,060 Ω	
	Coil inductance (H) (ref. value)	Armature OFF	0.11	0.15	0.18	0.52	1.2
		Armature ON	0.11	0.15	0.18	0.52	1.2
Reset coil	Rated current	93.2 mA	56 mA	46.8 mA	23.3 mA	11.7 mA	
	Coil resistance	32.2 Ω	89.2 Ω	128.5 Ω	515 Ω	2,060 Ω	
	Coil inductance (H) (ref. value)	Armature OFF	0.11	0.15	0.18	0.52	1.2
		Armature ON	0.11	0.15	0.18	0.52	1.2
Must set voltage		70% max. of rated voltage					
Must reset voltage		70% min. of rated voltage					
Max. voltage		130% of rated voltage (at 23°C)					
Power consumption		Set coil: Approx. 280 mW Reset coil: Approx. 280 mW					

Note: 1. The rated current and coil resistance are measured at a coil temperature of 23°C with a tolerance of ±10%.
2. Operating characteristics are measured at a coil temperature of 23°C.

■ Contact Ratings

Item	SPST-NO		SPST-NO + SPST-NC, DPST-NO, DPST-NC	
	Resistive load ($\cos\phi = 1$)	Inductive load ($\cos\phi = 0.4$; L/R = 7 ms)	Resistive load ($\cos\phi = 1$)	Inductive load ($\cos\phi = 0.4$; L/R = 7 ms)
Rated load	5 A at 250 VAC; 5 A at 30 VDC	2 A at 250 VAC; 2 A at 30 VDC	5 A at 250 VAC; 5 A at 30 VDC	1.5 A at 250 VAC; 1.5 A at 30 VDC
Contact material	AgCdO (Cd free planned 1 Apr 05)			
Rated carry current	5 A			
Max. switching voltage	380 VAC, 125 VDC			
Max. switching current	5 A			
Max. switching power	1,250 VA, 150 W	500 VA, 60 W	1,250 VA, 150 W	375 VA, 80 W
Failure rate (reference value)	10 mA at 5 VDC			

Item	SPST-NO (High-capacity)	
	Resistive load ($\cos\phi = 1$)	Inductive load ($\cos\phi = 0.4$; L/R = 7 ms)
Rated load	8 A at 250 VAC; 5 A at 30 VDC	2 A at 250 VAC; 2 A at 30 VDC
Contact material	AgCdO	
Rated carry current	8 A	
Max. switching voltage	380 VAC, 125 VDC	
Max. switching current	8 A	
Max. switching power	2,000 VA, 150 W	
Failure rate (reference value)	10 mA at 5 VDC	

Note: P level: $\lambda_{60} = 0.1 \times 10^{-6}$ /operation

■ Characteristics

Contact resistance	30 m Ω max.
Operate (set) time	10 ms max. (mean value: 1-pole approx. 3 ms, 2-pole approx. 4 ms)
Release (reset) time	Single-side stable types: 10 ms max. (mean value: 1-pole approx. 1 ms, 2-pole approx. 2 ms) Latching types: 10 ms max. (mean value: approx. 3 ms)
Min. set/reset signal width	Latching type: 15 ms min. (at 23°C)
Max. operating frequency	Mechanical: 18,000 operations/hr Electrical: 1,800 operations/hr (under rated load)
Insulation resistance	1,000 M Ω min. (at 500 VDC, at 250 VDC between set coil and reset coil)
Dielectric strength	3,000 VAC (Latching types: 2,000 VAC), 50/60 Hz for 1 min between coil and contacts 1,000 VAC, 50/60 Hz for 1 min between contacts of same polarity 250 VAC, 50/60 Hz for 1 min between set and reset coils 2,000 VAC, 50/60 Hz for 1 min between contacts of different polarity
Vibration resistance	Destruction: 10 to 55 to 10 Hz, 0.75mm single amplitude (1.5mm double amplitude) Malfunction: 10 to 55 to 10 Hz, 0.75mm single amplitude (1.5mm double amplitude)
Shock resistance	Destruction: 1,000 m/s ² Malfunction: Single-side stable: 100 m/s ² ; Latching: 300 m/s ²
Endurance	Mechanical: 50,000,000 operations min. (at 18,000 operations/hr) Electrical: 100,000 operation min. (at 1,800 operations/hr)
Ambient temperature	Operating: -25°C to 70°C (with no icing)
Ambient humidity	Operating: 5% to 85%
Weight	Double-winding latching: Approx. 3.7 g High-capacity: Approx. 4.6 g Double pole: Approx. 4.5 g Other: Approx. 3.5 g

Note: The data shown above are initial values.

■ Approved Standards

UL508 (File No. E41643)/CSA C22.2 No.14 (File No. LR31928)

EN 61810-1 (VDE Reg No. 5361)/Connector EN 61984 (VDE Reg No. 125603)

Model	Contact form	Coil ratings	Contact ratings
G6B-1114P-US G6B-1114C-US G6BU-1114P-US G6BU-1114C-US G6BK-1114P-US G6BK-1114C-US	SPST-NO	3 to 24 VDC	5 A, 250 VAC (general use) 5 A, 30 VDC (resistive load)
G6B-1174P-US G6B-1174C-US			8 A, 250 VAC (general use) 8 A, 30 VDC (resistive load)
G6B-2114P-US G6B-2114C-US G6B-2214P-US G6B-2214C-US G6B-2014P-US G6B-2014C-US	SPST-NO + SPST-NC DPST-NO DPST-NC		5 A, 250 VAC (general use) 5 A, 30 VDC (resistive load)

Engineering Data

G6B-1114P-US

Maximum Switching Power

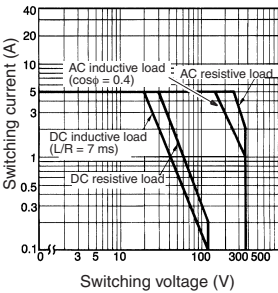

Endurance

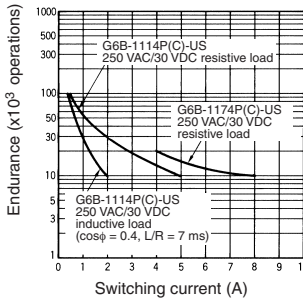

Ambient Temperature vs. Maximum Coil Voltage

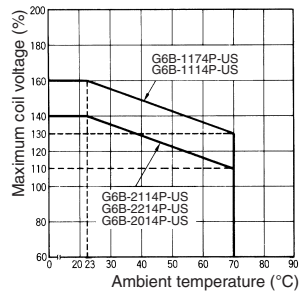

Note: The maximum coil voltage refers to the maximum value in a varying range of operating power voltage, not a continuous voltage.

G6B-2114P-US, G6B-2214P-US

G6B-2014P-US

Maximum Switching Power

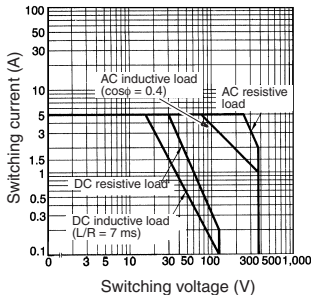

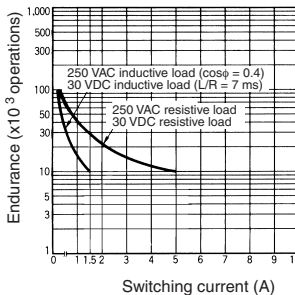

Endurance



Dimensions

Note: 1. All units are in millimeters unless otherwise indicated.

2. Orientation marks are indicated as follows:  

G6B-1114P-US G6BU-1114P-US

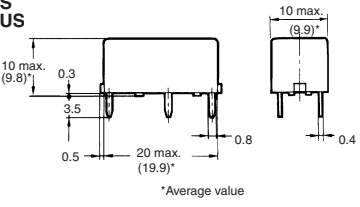
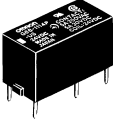

Terminal Arrangement/Internal Connections (Bottom View)
G6B-1114P, -1114C

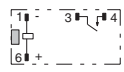

Mounting Holes (Bottom View)
G6B-1114P, -1114C
G6BU-1114P, -1114C

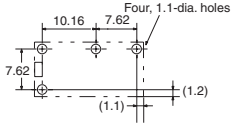

G6B-1114C-US G6BU-1114C-US

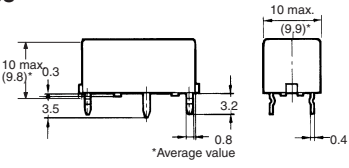
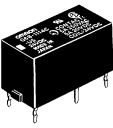

G6BU-1114P, -1114C

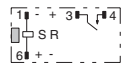

G6BK-1114P-US

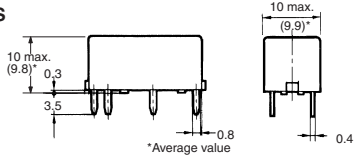
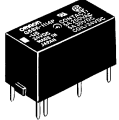

Terminal Arrangement/Internal Connections (Bottom View)
G6BK-1114P, -1114C

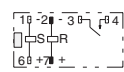

Mounting Holes (Bottom View)
G6BK-1114P, -1114C

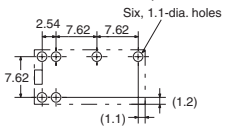

G6BK-1114C-US

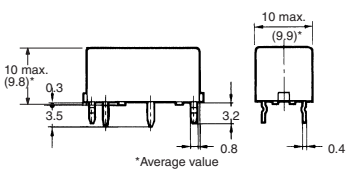
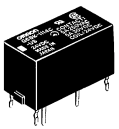

G6B-1174P-US

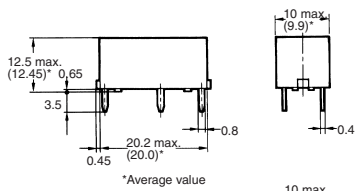

Terminal Arrangement/Internal Connections (Bottom View)
G6B-1174P, -1174C

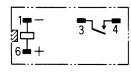

Mounting Holes (Bottom View)

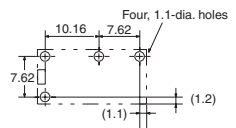

G6B-1174C-US

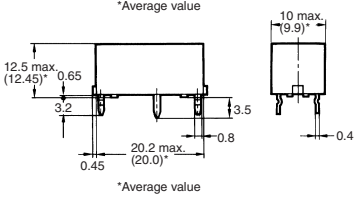

G6B-2114P-US
G6B-2214P-US
G6B-2014P-US

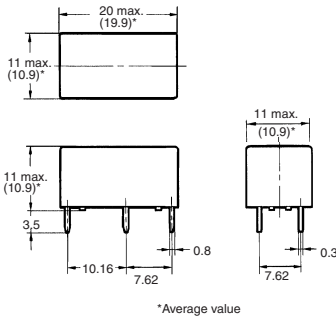
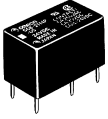

Terminal Arrangement/Internal Connections (Bottom View)

G6B-2114P-US

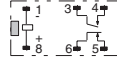

G6B-2214P-US

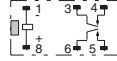

G6B-2014P-US



Mounting Holes (Bottom View)
Tolerance: ±0.1

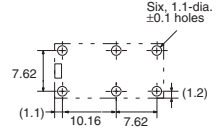

G6B-2114C-US
G6B-2214C-US
G6B-2014C-US

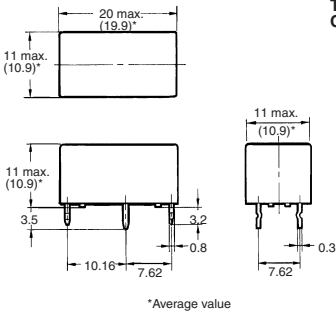
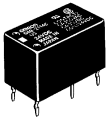

Terminal Arrangement/Internal Connections (Bottom View)

G6B-2114C-US

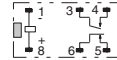

G6B-2214C-US

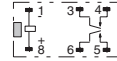

G6B-2014C-US

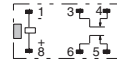

Mounting Holes (Bottom View)
Tolerance: ±0.1

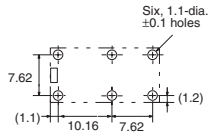

Back Connecting Socket
P6B-04P

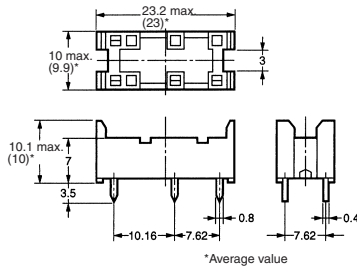
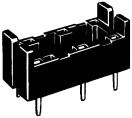

Mounting Holes (Bottom View)

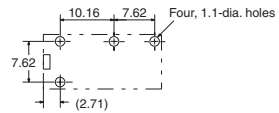

P6B-06P

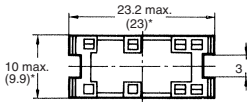
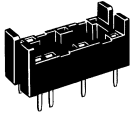

Mounting Holes (Bottom View)

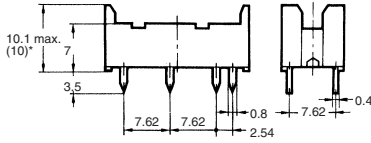
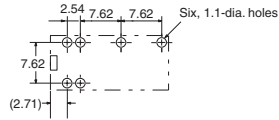

*Average value

P6B-26P

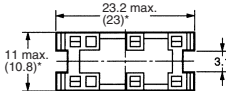
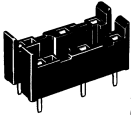

Mounting Holes (Bottom View)

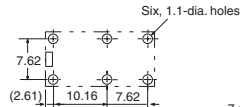

Mounting Height of Relay with Connecting Socket

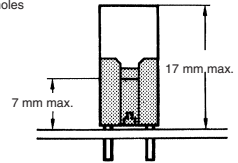

Note: Rated current of socket is 5 A max.

Note: Height of G6B-1174P-US is 19.5 mm max.

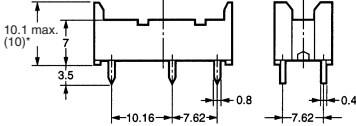

*Average value

**Removal Tool
P6B-Y1**

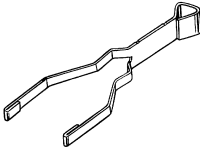

**Hold-down Clips
P6B-C2**

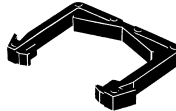

Note: P6B-C2 Hold-down Clips cannot be used for G6B-1174P-US.

ALL DIMENSIONS SHOWN ARE IN MILLIMETERS.

To convert millimeters into inches, multiply by 0.03937. To convert grams into ounces, multiply by 0.03527.