

# **INSTALLATION INSTRUCTIONS**

## **MSD Digital 6 Plus Ignition Control PN 6520**

**ONLINE PRODUCT REGISTRATION:** Register your MSD product online. Registering your product will help if there is ever a warranty issue with your product and helps the MSD R&D team create new products that you ask for! Go to [www.msperformance.com/registration](http://www.msperformance.com/registration).

### **Parts Included:**

1 - MSD Ignition

1 - Harness, PN 8860

1 - Parts Bag, ASY 19864

**WARNING:** During installation, disconnect the battery cables. When disconnecting the battery always remove the Negative cable first and install it last.

**Note:** Solid Core spark plug wires cannot be used with an MSD Ignition.

**Important:** When installing a Digital Series Ignition, the timing must be checked and reset to your engine's specifications.

### **REV LIMITER**

This Ignition features a built-in Soft Touch Rev Control with two different rpm limits. The Soft Touch circuitry provides a smooth and accurate rev limit by dropping the spark to individual cylinders. The Soft Touch produces a load-free rev limit that is within 1% of the selected rpm.

You can select two rev limits; one for a low limit that can be used when staging the car, and another limit for top end overrev protection. Both rpm limits are adjusted in 100 rpm increments with the sealed rotary switches on the side of the ignition. Using and programming the Two Step is explained in detail on page 6.

## **OPERATION AND FEATURES**

**Note:** Do not use digital or dial back timing lights.

### **DIGITAL OPERATION**

The MSD Digital 6 Plus uses a high speed RISC microcontroller to control the ignition's output while constantly analyzing the various inputs such as supply voltage, trigger signals and rpm. The high speed controller can make extremely quick compensations to the output voltage, multiple spark series, timing and rpm limits while maintaining accurate timing signals to within 1° and 1% of the rpm limits. The circuits and controller of the Digital 6 Plus have been thoroughly debounced and isolated to create protection against Electro Magnetic Interference (EMI).

### **CAPACITIVE DISCHARGE**

The MSD Digital 6 Plus features a capacitive discharge ignition design. The majority of stock ignition systems are inductive ignitions. In an inductive ignition, the coil must store and step up the voltage to maximum strength in between each firing. At higher rpm, since there is less time to charge the coil to full capacity, the voltage falls short of reaching maximum energy which results in a loss of power or top end miss.

The MSD Ignition features a capacitor which is quickly charged with 520 - 535 volts and stores it until the ignition is triggered. With the CD design, the voltage sent to the coil is always at full power even at high rpm.

### **MULTIPLE SPARKS**

The MSD produces full power multiple sparks for each firing of a plug. The number of multiple sparks that occur decreases as rpm increases, however the spark series always lasts for 20° of crankshaft rotation. Above 3,300 rpm there is simply not enough "time" to fire the spark plug more than once, so there is only one powerful spark.

## PROTECTION

The MSD Digital 6 Plus has a built in reverse polarity protection circuit. This will protect the ignition in the event of wrong connections. It will also shut off for protection from a surge in power. The ignition will still operate once the surge or polarity is corrected.

## LED INDICATOR

There is an LED that monitors the status of the Ignition. The LED monitors several parameters of the ignition including trigger signal, low voltage and high voltage.

## RETARD CONTROL

There is a single stage of retard that can be adjusted from 0 to 9.9 degrees in 1/10° increments. The retard is activated when the Pink wire receives 12 volts which is explained on page 6.

## START RETARD

To ease starting on engines with locked out timing, there is a Start Retard circuit. When set, the timing will be retarded 20° until the engine reaches over 800 rpm. Activating the Start Retard is done with the Cylinder Select dial and is explained on page 5.

## CYLINDER SELECT

The MSD is programmed at the factory for use on 8-cylinder engines. If you are installing it to a different engine you will have to program the Ignition. This is easily achieved through the cylinder select switch on the side of the ignition. Page 5 outlines setting the cylinder select.

## GENERAL INFORMATION

### BATTERY

An MSD 6 Series Ignition Control will operate on any negative ground, 12 volt electrical system with a distributor. The MSD can be used with 16 volt batteries and can withstand a momentary 24 volts in case of jump starts. The Ignition will deliver full voltage with a supply of 9 - 18 volts and will operate with a supply voltage as low as six volts.

If your application does not use an alternator, allow at least 15 amp/hour for every half hour of operation. The MSD uses about .7 Amps for every 1,000 rpm. If the engine is cranked with the same battery or other accessories such as an electric fuel or water pump are used, the amp/hour rating should be higher.

### COILS

The MSD Digital 6 Plus Ignition can be used with most stock coils and aftermarket coils designed to replace the stock coils. The line of MSD Blaster Coils are great for street and mild racing. For extended high rpm operation the Blaster HVC, PN 8252, is recommended. For more information on recommended coils, consult the supplied Coil Application Chart or check with our Customer Service Department at (915) 855-7123.

### TACHOMETERS

The MSD Ignition features a Tach Output Terminal on the side of the unit (Figure 1). This terminal provides a trigger signal for tachometers, a shift light or other add-on rpm activated devices. The Tach Output Terminal produces a 12 volt square wave signal with a 30° duty cycle.

Some vehicles with factory tachometers may require a Tach Adapter to operate with the MSD. For more information on Tachometers and MSD Tach Adapters, see the Tachometer Section on page 7.

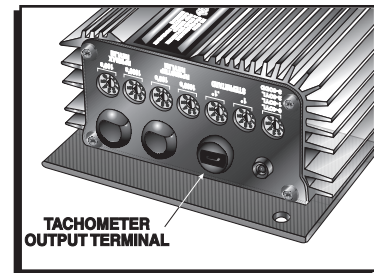

Figure 1 Tach Terminal

If your GM vehicle has an inline filter it may cause the tach to drop to zero on acceleration. If this occurs, bypass the filter.

**SPARK PLUGS AND WIRES**

Spark plug wires are very important to the operation of your ignition system. A good quality, helically wound wire and proper routing are required to get the best performance from your ignition, such as the MSD Heli-Core or 8.5mm Super Conductor Wire. Helically wound wires provide a good path for the spark to follow while keeping Electro Magnetic Interference (EMI) to a minimum. Excessive EMI, such as the amount that solid core wires produce, will interfere with the operation of the MSD. **Solid Core spark plug wires cannot be used with an MSD Ignition.**

**Routing:** Correct routing of the plug wires is also important to performance. Wires should be routed away from sharp edges and engine heat sources. If there are two wires that are next to each other in the engine's firing order, the wires should be routed away from each other to avoid inducing a spark into the other wire. For example, in a Chevy V8, the firing order is 1-8-4-3-6-5-7-2. The #5 and #7 cylinders are next to each other in the engine and in the firing order. If the voltage from the #5 wire is induced into #7 detonation could occur and cause engine damage.

To add more heat protection to your plug wires, MSD offers Pro-Heat Guard, PN 3411. This is a glass woven and silicone coated protective sleeve that you slide over your plug wires. For extra protection of the spark plug boots, MSD offers Pro Boot Guard, PN 3412.

**Spark Plugs:** Choosing the correct spark plug design and heat range is important when trying to get the best performance possible. Since there are so many engine combinations and manufacturers, MSD does not recommend which plug or gap is exactly right for your application.

It is recommended to follow the engine builder or manufacturer's specification for spark plugs. With that, you can then experiment with the plug gap to obtain the best performance. The gap of the plugs can be opened in 0.005" increments, then tested until the best performance is obtained. MSD judges the plug gap by compression and components.

These examples are just starting points to get you going in the right direction. Every application is different and should be tested and tuned.

<b>Compression</b>	<b>Spark Plug Gap</b>
Up to 10.5:1:	0.050" - 0.060"
10.5:1 - 13.0:1:	0.040" - 0.050"
Above 13.0:1:	0.035" - 0.045"

**Welding:** If you are welding on your vehicle, to avoid the chance of damage, always disconnect both Heavy Power cables of the MSD (You should also disconnect the tach ground wire too).

**Distributor Cap and Rotor:** It is recommended to install a new distributor cap and rotor when installing the MSD Ignition Control. The cap should be clean inside and out especially the terminals and rotor tip. On vehicles with smaller caps, it is possible for the air inside the cap to become electrically charged causing crossfire which can result in misfire. This can be prevented by drilling a couple vent holes in the cap. The holes should be placed between the terminals, at rotor height and face away from the intake. If your environment demands it, place a small piece of screen over the hole to act as a filter.

**MOUNTING**

The MSD can be mounted in the engine compartment as long as it is away from direct engine heat sources. It is not recommended to mount the unit in an enclosed area such as the glovebox.

When you find a suitable location to mount the unit, make sure the wires of the ignition reach their connections. Also be sure that the program dials can be accessed. Hold the Ignition in place and mark the location of the mounting holes. Use an 1/8" bit to drill the holes or, if using the supplied vibration mounts, use a 3/16" bit and mount the ignition.

## **WIRING**

<b>Power Leads</b>	These are the two heavy 12 gauge wires and are responsible for getting direct battery voltage to the ignition. The Ignition is load protected from reverse battery connections and will automatically shut down if there is over 27 volts input.
<b>Heavy Red</b>	This wire connects directly to the battery positive (+) terminal or a positive battery junction such as the starter solenoid. <b>Note:</b> Do not connect to the alternator.
<b>Heavy Black</b>	This wire connects to a good ground, either at the battery negative (-) terminal or to the engine.
<b>Red</b>	This wire is responsible for turning the MSD On and Off. Connects to a switched 12 volt source such as the ignition key or switch.
<b>Orange</b>	This wire connects to the coil positive (+) terminal. This is the <b>ONLY</b> wire that makes electrical contact with the positive coil terminal.
<b>Black</b>	This wire connects to the coil negative (-) terminal. This is the <b>ONLY</b> wire that makes electrical contact with the negative coil terminal.
<b>Trigger Wires</b>	There are two circuits that can be used to trigger the MSD Ignition; a Points circuit (the White wire) and a Magnetic Pickup circuit (the Green and Violet wires). The two circuits will <b>never</b> be used at the same time.
<b>White</b>	This wire is used to connect to breaker points, electronic ignition amplifier output or to the Yellow wire of an MSD Timing Accessory. <b>When this wire is used, the Magnetic Pickup connector is not used.</b>
<b>Violet and Green (Magnetic Pickup Connector)</b>	These wires are routed together in one harness as the magnetic pickup connector. The connector plugs directly into an MSD distributor or crank trigger. It will also connect to aftermarket pickups. The Violet wire is positive (+) and the Green wire is negative (-). <b>When these wires are used, the White wire is not.</b>
<b>Green Loop</b>	This wire loops out of the strain relief. It is used to compensate for different magnetic pickups. The MSD is set up to be used with GM distributor and MSD crank triggers. If you are installing the ignition with an MSD Distributor or Ford Distributor, this Loop should be cut and sealed.
<b>Accessories Blue</b>	This wire activates the Two Step Rev Control. When 12 volts is applied to this wire, the low rpm limit is activated. When 12 volts is removed, the rev limit returns to the high limit.
<b>Pink</b>	This wire activates the retard stage when it is applied to 12 volts. When 12 volts is removed the retard is deactivated.

### **GENERAL WIRING INFORMATION**

**Wire Length:** All of the wires of the MSD Ignition may be shortened as long as quality connectors are used or soldered in place. To lengthen the wires, use one size bigger gauge wire (10 gauge for the power leads and 16 gauge for the other wires) with the proper connections. All connections must be soldered and sealed.

**Grounds:** A poor ground connection can cause many frustrating problems. When a wire is specified to go to ground, it should be connected to the battery negative terminal, engine block or chassis. There should always be a ground strap between the engine and the chassis. Always securely connect the ground wire to a clean, paint free metal surface.

**Ballast Resistor:** If your vehicle has a ballast resistor in line with the coil wiring, it is recommended to bypass it.

**Routing Wires:** The MSD wires should be routed away from direct heat sources such as exhaust manifolds and headers and any sharp edges. The trigger wires should be routed separate from the other wires and spark plug wires. It is best if they are routed along a ground plane such as the block or firewall which creates an electrical shield. The magnetic pickup wires should always be routed separately and should be twisted together to help reduce extraneous interference.

**PROGRAMMING**

**CYLINDER SELECT**

The MSD is programmed for operation on 8-cylinder engines. If installing the Ignition on a different style engine, the number of cylinders will need to be selected on the Cylinder Select Rotary Switch (Figure 2).

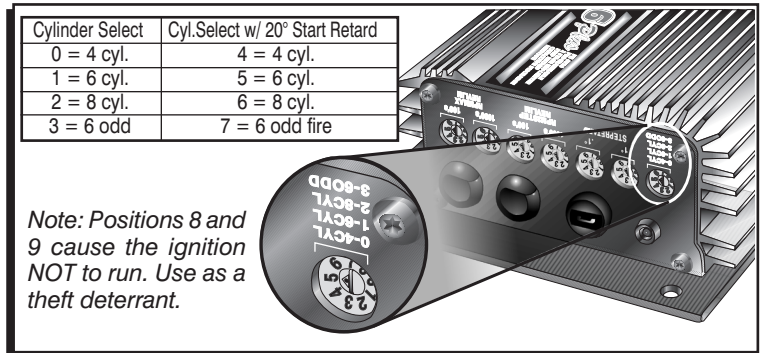

**Figure 2 Programming the Number of Cylinders.**

**START RETARD**

The Start Retard will be activated during cranking only when the Cylinder Select dial is in the 4, 5, 6 or 7 position (Figure 2). During cranking the timing will retard 20° until 800 rpm when it returns to the mechanical setting. If engine speed drops below 500 rpm, the start retard is activated again.

**MAGNETIC PICKUP COMPENSATION**

**Note:** If your application uses the MSD's White wire for the trigger input, the magnetic compensation circuit is not used.

The Green wire loop of the MSD provides a timing compensation for different style trigger pickups. Having the ability to program for the style pickup being used provides a more accurate timing signal. This compensation is used primarily with crank trigger or locked out timing applications.

The Digital MSD is programmed at the factory for use with an MSD Crank Trigger or GM magnetic pickup. If you are using an MSD Billet Distributor or the magnetic pickup of a Ford or Chrysler distributor the Green Loop should be cut and sealed (Figure 3).

**Note:** It is recommended to check your total timing to ensure the setting for your application.

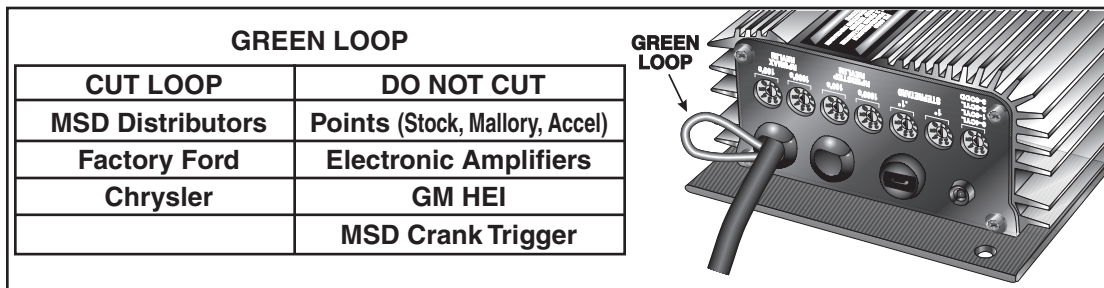

**Figure 3 Programming the Compensation Circuit.**



## REV LIMITER

There are two adjustable rev limits that you can adjust; the Max Limit and the Two Step Limit. Both limits are adjusted in 100 rpm increments by turning the rotary switches on the side of the Ignition (Figure 4). **Note:** The engine can be running as you make adjustments to the rev limiter and retard function.

**Max Limit:** This is the overrev rpm limit. The Soft Touch circuitry will begin dropping the spark to cylinders any time the rpm reaches the amount you select, except if the Two Step Limit is activated (12 volts applied to the Blue wire). The limit can be adjusted from 2,000 to 9,900 rpm. Setting both dials to Zero defaults to a limit of 12,500 rpm.

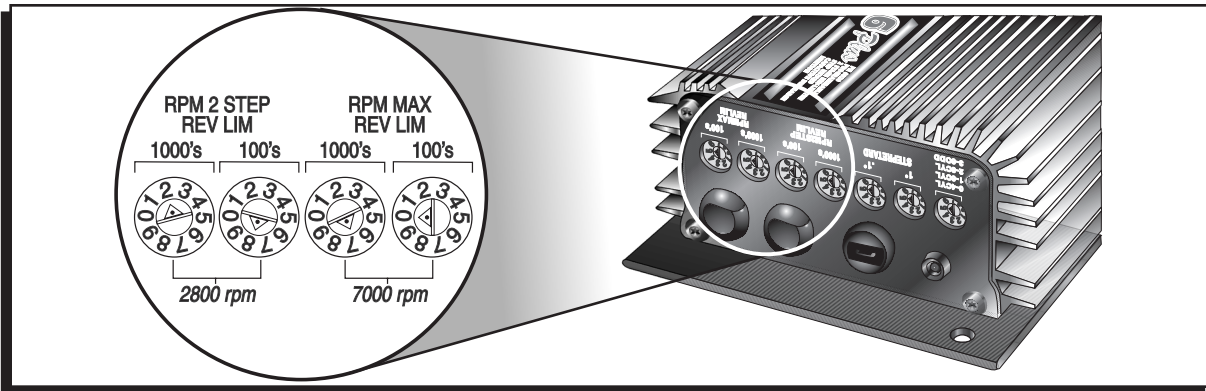

Figure 4 Adjusting the Rev Limits.

**2-Step Limit:** This rpm limit is activated when 12 volts are applied to the Blue wire. When activated, this limit overrides the Max Limit. This limit is adjustable from 2,000 to 9,900 and will default to 2,000 rpm if the dials are set to an rpm below this range. An example of wiring the 2-Step Limit so it is activated with the line-lock is shown in Figure 5.

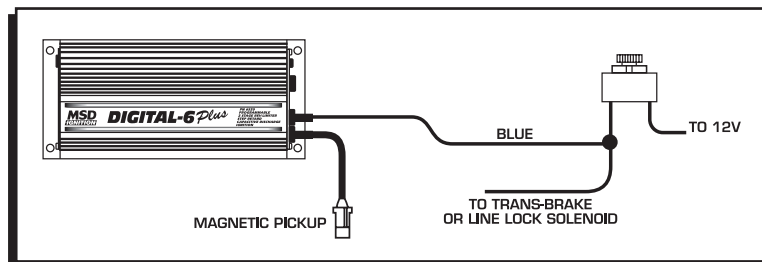

Figure 5 Wiring the 2-Step Rev Limit.

## RETARD STAGE

The MSD features a single stage retard step that is activated when 12 volts are applied to the Pink wire. The retard will remain until the 12 volts are removed. This retard step can be connected to a nitrous solenoid activation wire or micro-switch on the shifter. The retard is adjustable from 0° to 9.9° in 1/10° increments. The example in Figure 6 shows connecting the retard to a nitrous stage.

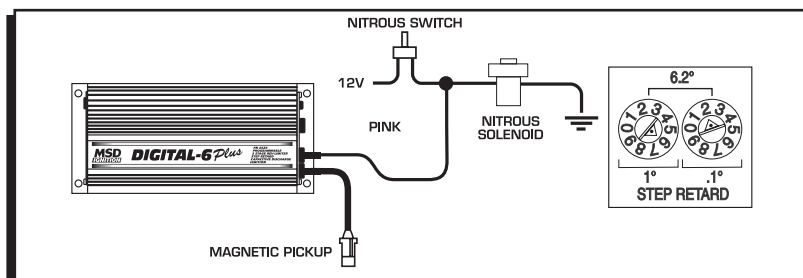

Figure 6 Wiring the Retard Stage.

**Note:** This retard will only operate above 2,000 rpm.

**PRESTART CHECK LIST**

- The only wires connected to the coil terminals are the MSD Orange to coil positive and Black to coil negative.
- The small Red wire of the MSD is connected to a switched 12 volt source.
- Confirm the cylinder select is in the proper position for your application.
- The MSD power leads are connected directly to the battery positive and negative terminals.
- The battery is connected and fully charged if not using an alternator.
- The engine is equipped with at least one ground strap to the chassis.

**TROUBLESHOOTING**

Every MSD Ignition undergoes numerous quality control checks including a four hour burn-in test. If you experience a problem with your MSD, our research has shown that the majority of problems are due to improper installation or poor connections.

The Troubleshooting section has several checks and tests you can perform to ensure proper installation and operation of the MSD. If you have any questions concerning your MSD, call our Customer Support Department at (915) 855-7123, 7 - 6 mountain time.

**LED**

The LED on the side of the MSD monitors several operating conditions of the MSD. If the LED indicates that there is a problem with the ignition system, follow the steps through the Troubleshooting section. The LED will appear to be on steady at above idle speeds when everything is functioning properly.

- Flashes once per second if the battery supply voltage is low when under 3,300 rpm (while multiple sparking). This indicates a charging problem or poor connection.
- It will flash approximately once per second if the battery input voltage is above 27 volts for a sustained amount of time.
- The LED will flash for every trigger signal from the distributor or crank trigger. You can take advantage of this when statically setting the timing when using the White wire to trigger.

**TACH/FUEL ADAPTERS**

If your tachometer does not operate correctly or if you experience a no-run situation with your foreign vehicle you probably need an MSD Tach Adapter. The chart in Figure 7 lists common tachometers and if an Adapter is necessary.

<b>Tachometer Compatibility List</b>		
<b>AFTERMARKET TACHOMETER</b>	<b>WHITE WIRE TRIGGER</b>	<b>MAGNETIC TRIGGER CONNECTOR</b>
AUTOGAGE	8910	8920
AUTOMETER	NONE	NONE
FORD MOTORSPORTS	NONE	NONE
MALLORY	NONE	NONE
MOROSO	NONE	NONE
STEWART (voltage triggered)	8910	8920
S.W. & BI TORX	NONE	NONE
SUN	8910	8920
VDO	NONE	NONE
AMC (JEEP)	8910	8920
CHRYSLER	8910	8920
FORD (voltage triggered)	8910	8920
GENERAL MOTORS	Bypass In-Line Filter	Bypass In-line filter
IMPORTS	8910	8920

Note: On the list above, the trigger wire on tachometers that are marked NONE may be connected to the Tach Output Terminal on the MSD 6 Series Ignition Unit using the supplied Female Faston Receptacle.

**Figure 7 Common Tachometers and Adapters.**

## NO-RUN ON FOREIGN VEHICLES

Some foreign vehicles with fuel injection systems may require an MSD Tach/Fuel Injection Adapter to run with an MSD 6 Series Ignition. This is because many of these systems use the same trigger source to operate the MSD, the tachometer and the fuel injection. This results in a voltage signal that is too low to accurately trigger the fuel injection. To fix this, an MSD Tach Adapter, PN 8910, will remedy the problem on the majority of vehicles. If the PN 8910 does not fix the problem, the PN 8910-EIS will be required.

**Note:** Toyotas and Ford Probes will require the PN 8910-EIS Adapter.

## INOPERATIVE TACHOMETERS

If your tachometer fails to operate with the MSD installed you may need an MSD Tach Adapter. Before getting an Adapter, try connecting your tachometer trigger wire to the tach output terminal on the side of the MSD. This output produces a 12 volt, square wave (see page 2). If the tach still does not operate, you will need a Tach Adapter. There are two Tach Adapters:

**PN 8920:** If you are using the Magnetic Pickup connector (Green and Violet wires) to trigger the MSD, you will need the PN 8920.

**PN 8910:** If your tachometer was triggered from the coil negative terminal (voltage trigger) and you are using the White wire to trigger the MSD you will need the PN 8910.

## BALLAST RESISTOR

If you have a current trigger tach (originally coil positive) and use the White wire of the MSD, you can purchase a Chrysler Dual Ballast Resistor (used from 1973 - 1976) and wire it as shown in Figure 8.

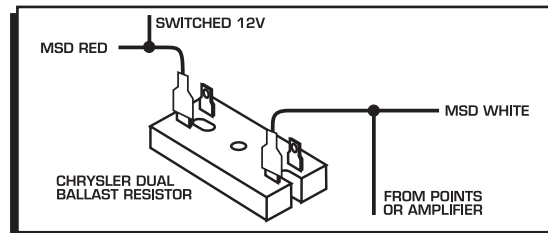

Figure 8 Wiring the Dual Ballast Resistor.

## ENGINE RUN-ON

If your engine continues to run even when the ignition is turned Off you are experiencing engine Run-On. This usually only occurs on older vehicles with an external voltage regulator. Because the MSD receives power directly from the battery, it does not require much current to keep the unit energized. If you are experiencing run-on, it is due to a small amount of voltage going through the charging lamp indicator and feeding the small Red wire even if the key is turned off.

**Early Ford and GM:** To solve the Run-On problem, a Diode is supplied with the MSD in the parts bag. By installing this Diode in-line of the wire that goes to the Charging indicator, the voltage is kept from entering the MSD. Figure 9 shows the proper installation for early Ford and GM vehicles.

**Note:** Diodes are used to allow voltage to flow only one way. Make sure the Diode is installed facing the proper direction (as shown in Figure 9).

**Ford:** Install the Diode in-line to the wire going to the "1" terminal.

**GM:** Install the Diode in-line to the wire going to terminal #4.

**GM:** 1973 - 1983 with Delcotron Alternators

**GM:** Delcotron Alternators use an internal voltage regulator. Install the Diode in-line on the smallest wire exiting the alternator (Figure 10). It is usually a Brown wire.

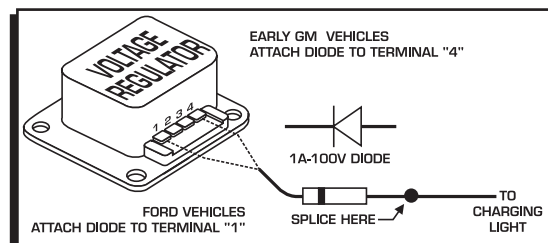

Figure 9 Installing the diode to a GM or Ford Vehicle.

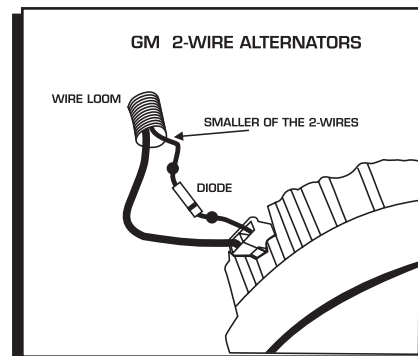

Figure 10 Installing the Diode to a 1973-1983 GM Vehicle.



**MISSES AND INTERMITTENT PROBLEMS**

Experience at the races has shown that if your engine is experiencing a miss or hesitation at higher rpm, it is usually not directly ignition. Most probable causes include faulty wiring, a coil or plug wire failure, arcing from the cap or boot plug to ground or spark ionization inside the cap. Several items to inspect are:

- Always inspect the plug wires at the cap and at the plug for a tight connection and visually inspect for cuts, abrasions or burns.
- Inspect the Primary Coil Wire connections. Because the MSD is a Capacitive Discharge ignition and it receives a direct 12 volt source from the battery, there will not be any voltage at the Coil Positive (+) terminal even with the key turned On. During cranking or while the engine is running, very high voltage will be present and no test equipment should be connected.

**WARNING:** Do not touch the coil terminals during cranking or while the engine is running.

- Make sure that the battery is fully charged and the connections are clean and tight. If you are not running an alternator this is an imperative check. If the battery voltage falls below 9 volts during a race, the MSD output voltage will drop and the current draw will increase.
- Is the engine running lean? Inspect the spark plugs and complete fuel system.
- Inspect all wiring connections for corrosion or damage. Remember to always use proper connections followed by soldering and seal the connections completely.

If everything checks positive, use the following procedure to test the ignition for spark. MSD also offers an Ignition Tester, PN 8998 or PN 8996. This tool allows you to check your complete ignition system while it is in the car as well as the operation of rpm limits, activated switches and shift lights.

**CHECKING FOR SPARK**

If triggering the ignition with the White wire:

1. Make sure the ignition switch is in the "Off" position.
2. Remove the coil wire from the distributor cap and set the terminal approximately 1/2" from ground.
3. Disconnect the MSD White wire from the distributor's points or ignition amplifier.
4. Turn the ignition to the On position. Do not crank the engine.
5. Tap the White wire to ground several times. Each time you pull the wire from ground, a spark should jump from the coil wire to ground. If spark is present, the ignition is working properly. If there is no spark skip to step 6 on page 10:

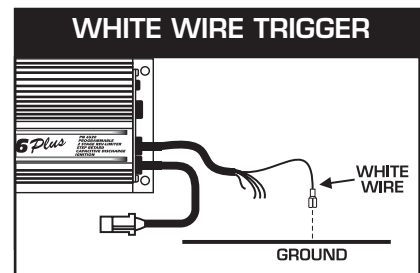

**Figure 11 Checking for Spark with the White Wire.**

If triggering with the Magnetic Pickup:

1. Make sure the ignition switch is in the "Off" position.
2. Remove the coil wire from the distributor cap and set the terminal approximately 1/2" from ground.
3. Disconnect the MSD magnetic pickup wires from the distributor.
4. Turn the ignition to the On position. Do not crank the engine.
5. With a small jumper wire, short the MSD's Green and Violet magnetic pickup wires together several times. Each time you break this short, a spark should jump from the coil wire to ground. If spark is present, the ignition is working properly. If there is no spark skip to step 6 on page 10.

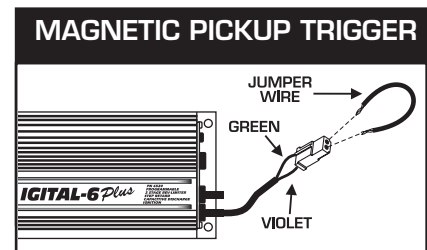

**Figure 12 Checking for Spark with the Mag Pickup.**

6. If there is no spark:
  - A. Inspect all of the wiring.
  - B. Substitute another coil and repeat the test. If there is now spark, the coil is at fault.
  - C. If there is still no spark, check to make sure there are 12 volts on the small Red wire from the MSD when the key is in the On position. If 12 volts are not present, find another switched 12 volt source and repeat the test.
  - D. If, after following the test procedures and inspecting all of the wiring, there is still no spark, the MSD Ignition is in need of repair. See the Warranty and Service section for information.

The following wiring diagrams illustrate numerous installations on different vehicles and applications. If you experience difficulties when installing your MSD, contact our Customer Support Department at (915) 855-7123 (7 - 6 Mountain time) or e-mail us at: [msdtech@msdignition.com](mailto:msdtech@msdignition.com)

**MSD SYSTEMS Installing to Points/Amplifier Style Ignition.**

**NOTE:** On dual point setups, it is recommended to remove the trailing set of points.

**NOTE:** Ballast Resistor is not necessary.

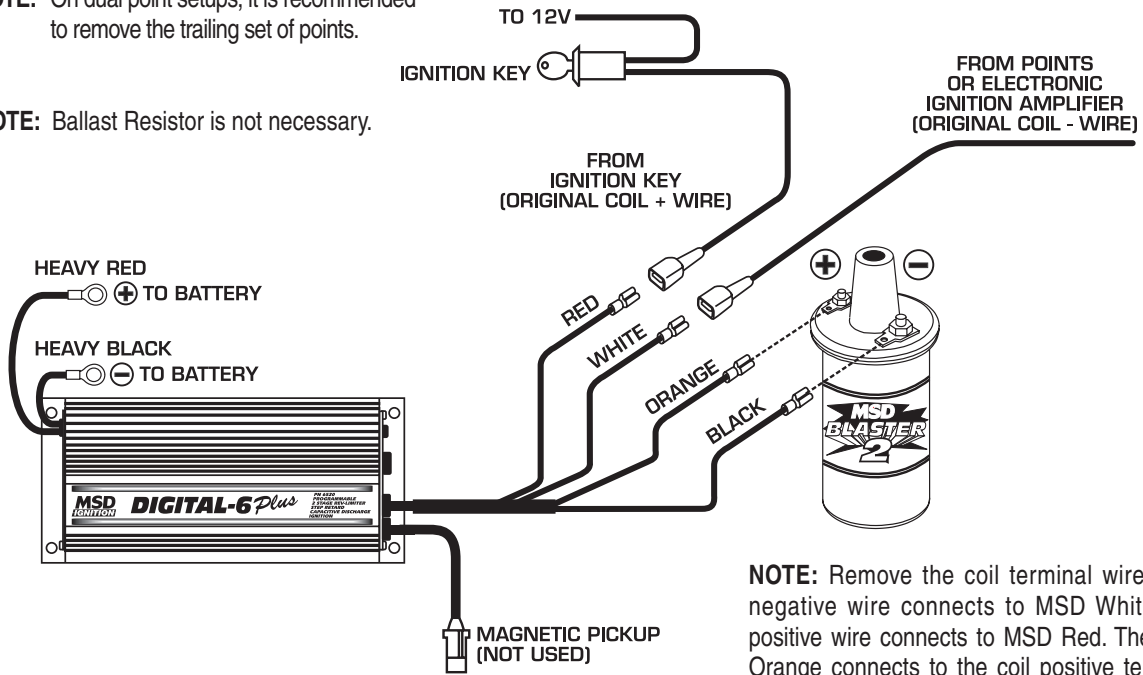

**NOTE:** Remove the coil terminal wires. The negative wire connects to MSD White. The positive wire connects to MSD Red. The MSD Orange connects to the coil positive terminal, Black connects to the coil negative terminal.

**MSD SYSTEMS Installing to an MSD Distributor/Crank Trigger.**

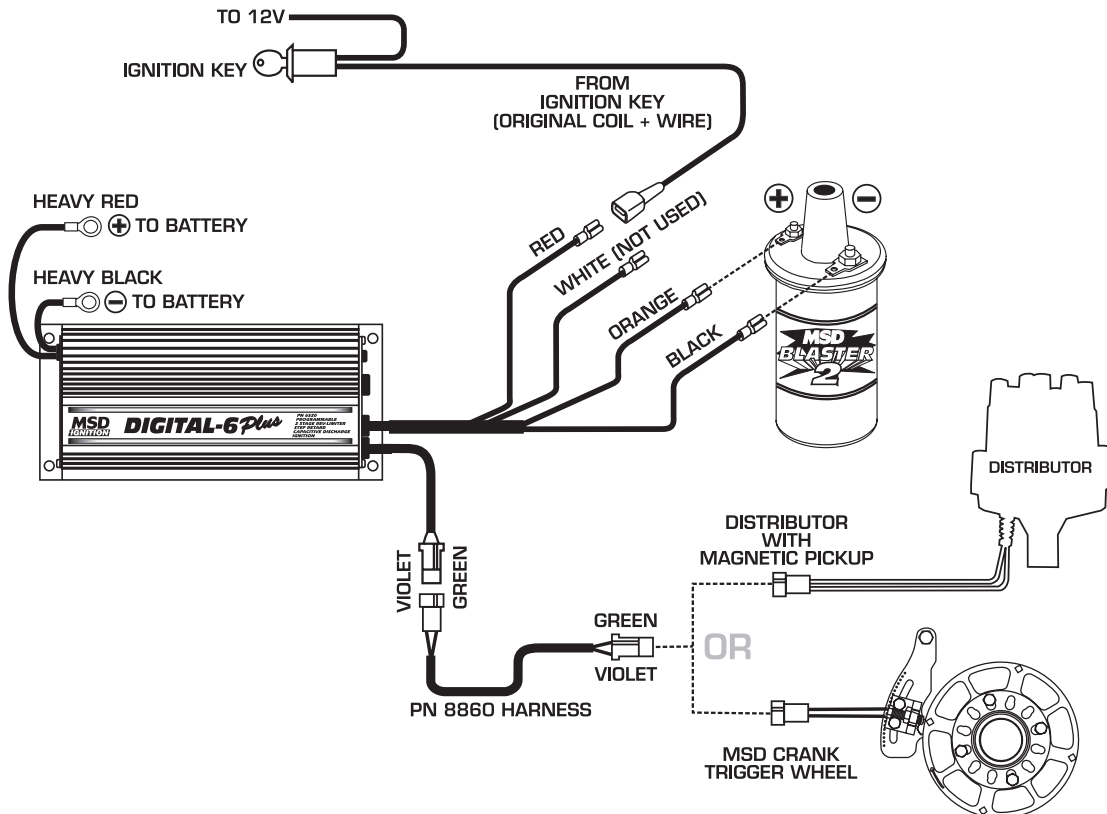

**MSD SYSTEMS Installing to an MSD Distributor PN 8360.**

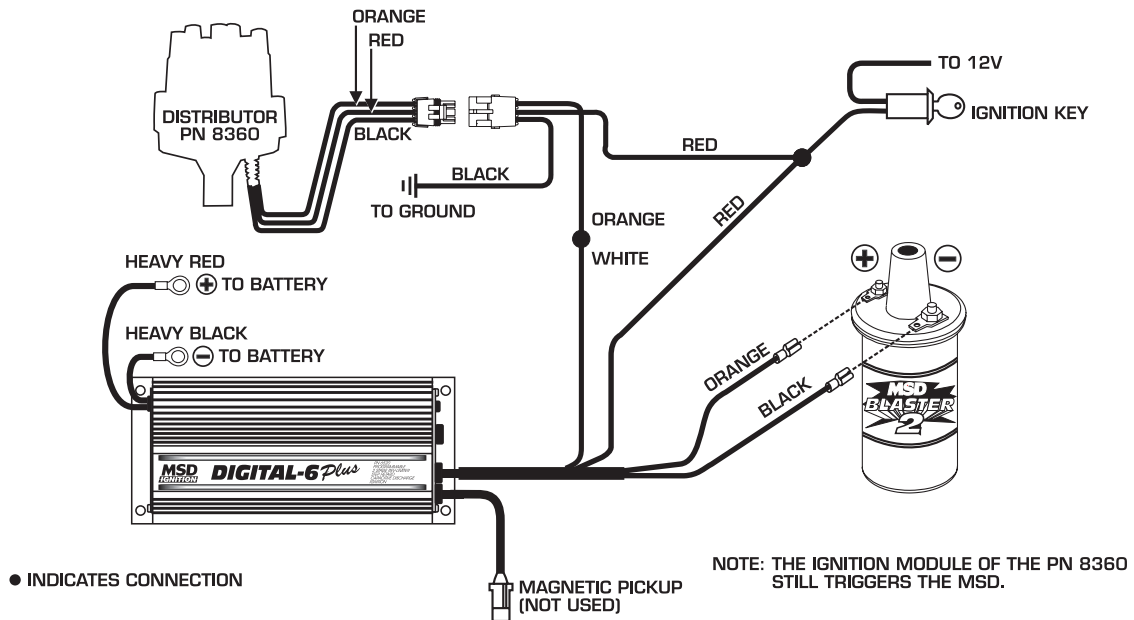

**MSD SYSTEMS Wiring a Complete Dual MSD Ignition Setup.**

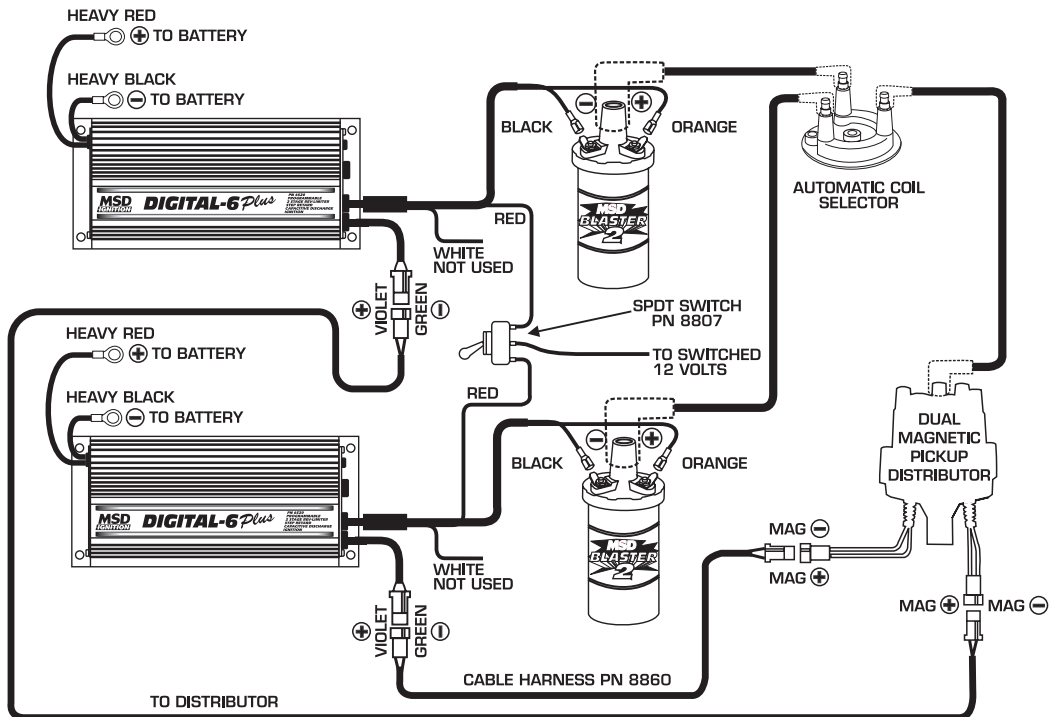

**MSD SYSTEMS With an MSD Timing Control (points or amplifier).**

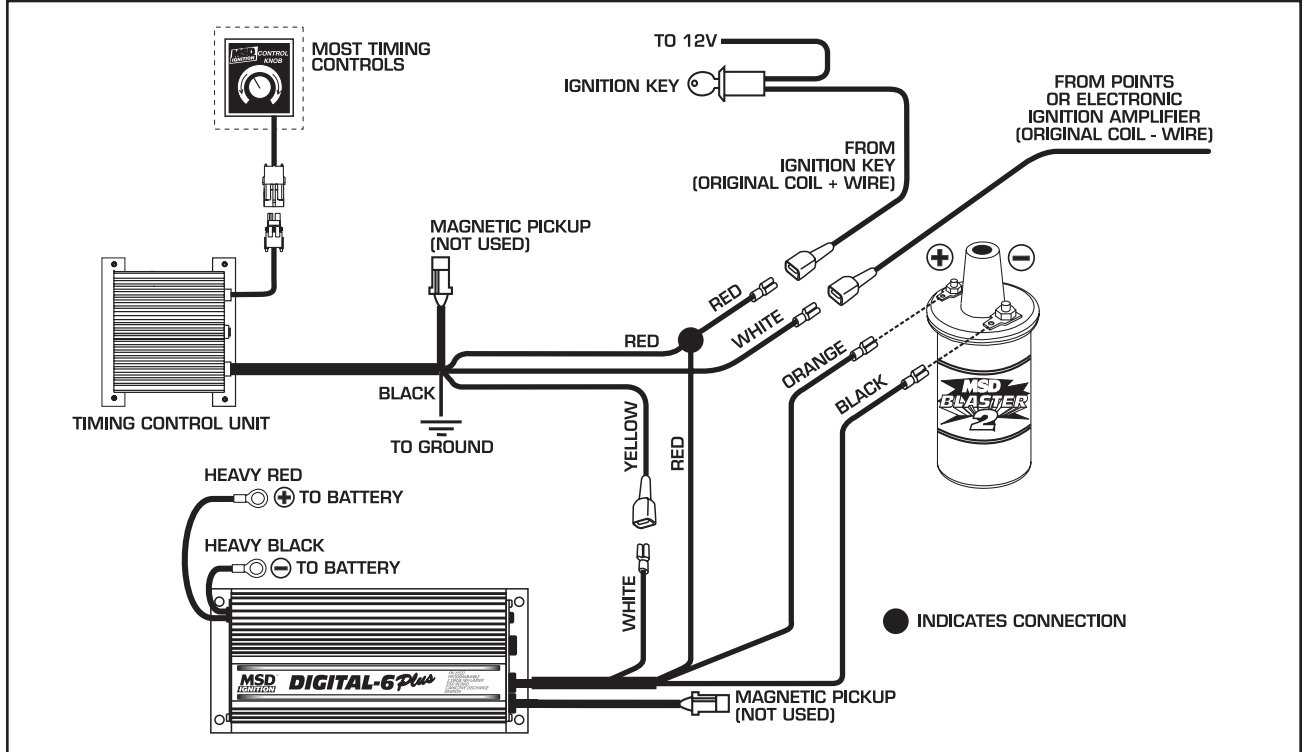

**MSD SYSTEMS Typical Drag Race Setup with Timing Control and Two Step Selector.**

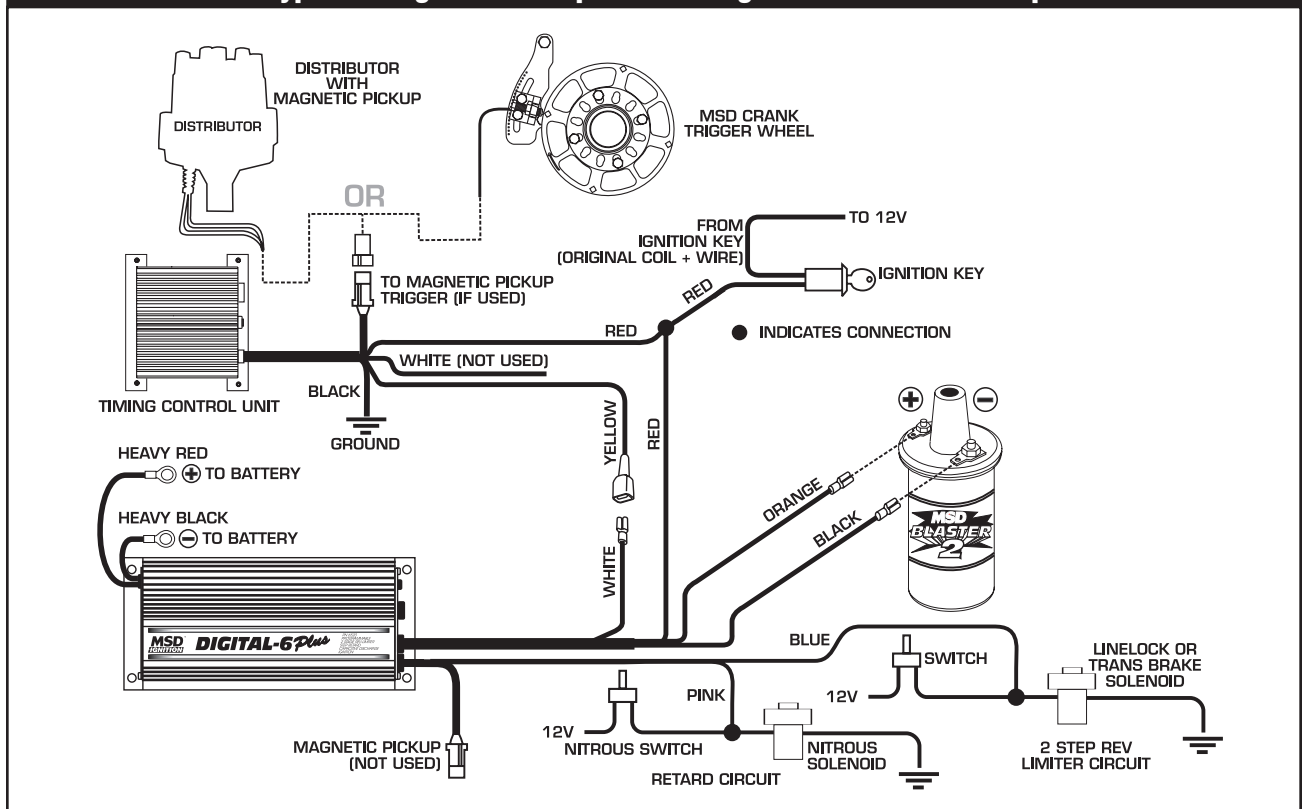



**GM IGNITIONS Wiring a Dual Connector Coil.**

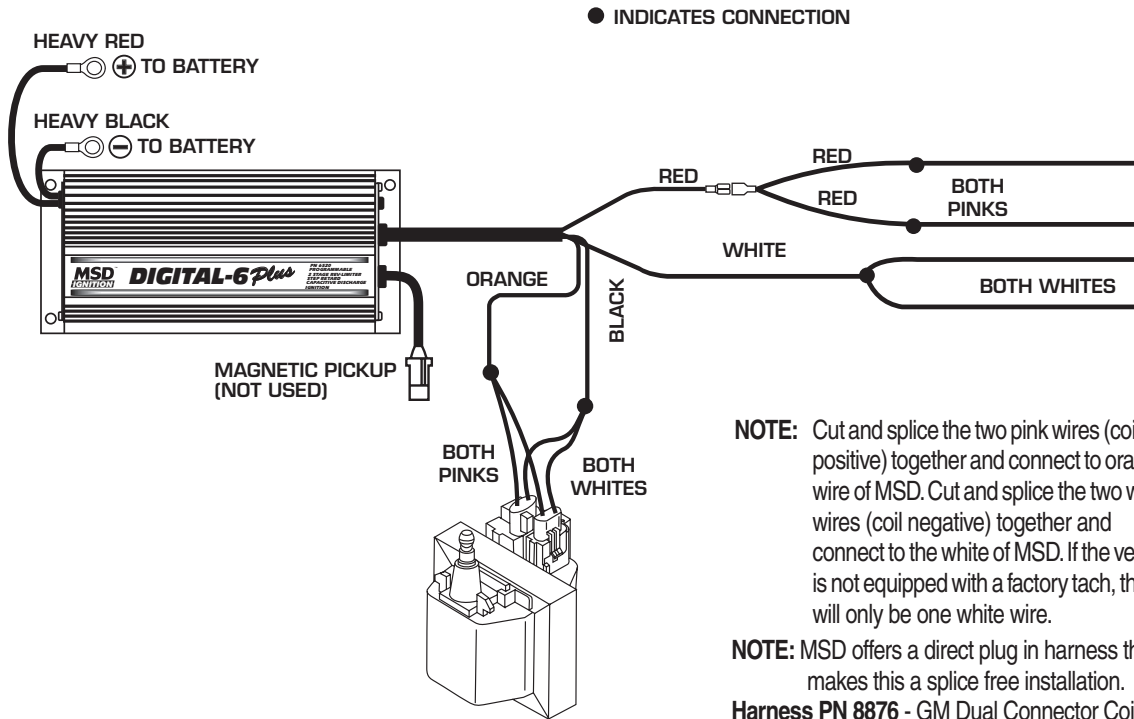

**GM IGNITIONS Wiring the 1996 and up single connector coil without harness.**

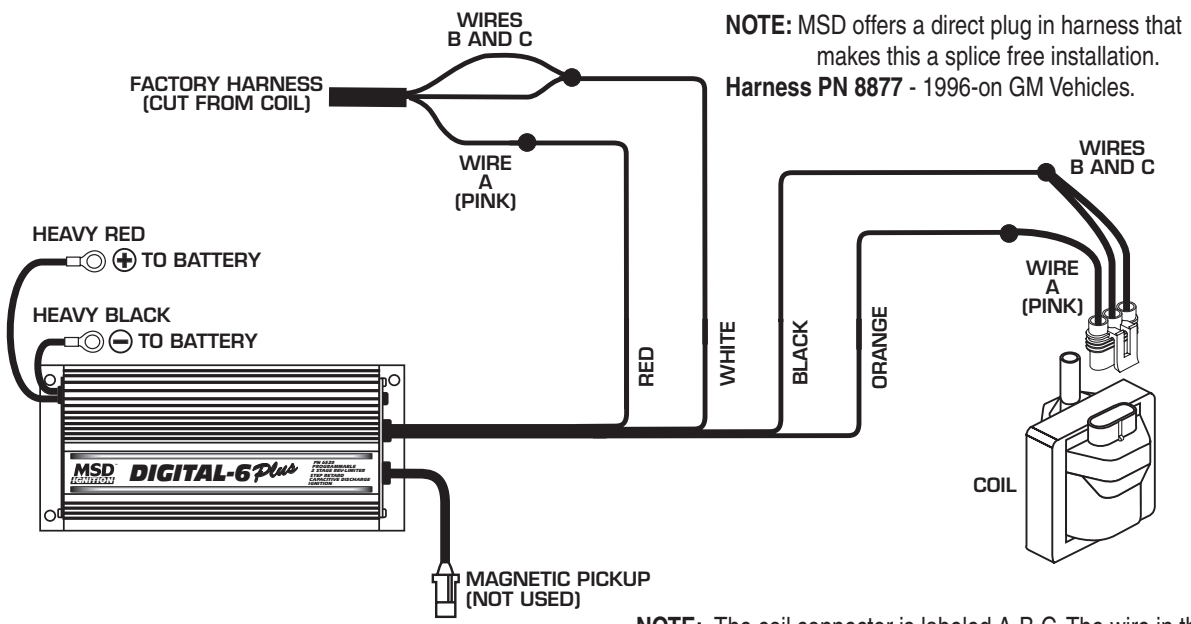

**GM IGNITIONS Wiring with an MSD Wiring Harness.**

Harness PN 8876 - Dual Connector Coil.  
 Harness PN 8877 - 1996-on GM Vehicles.

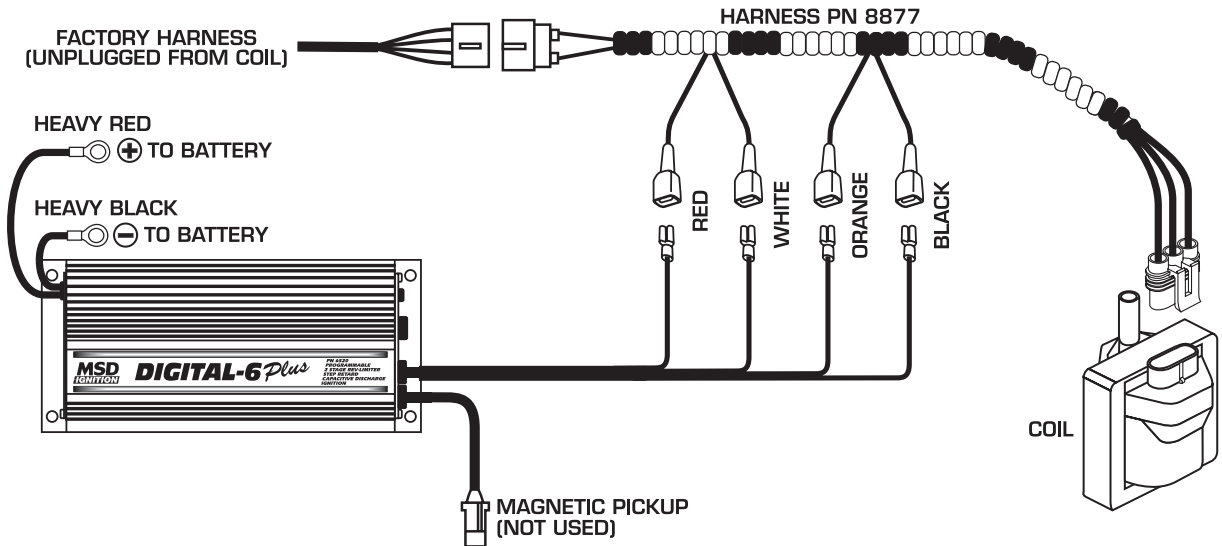

**GM IGNITIONS Wiring with an MSD Wiring Harness and a Timing Control.**

Harness PN 8876 - Dual Connector Coil.  
 Harness PN 8877 - 1996-on GM Vehicles.

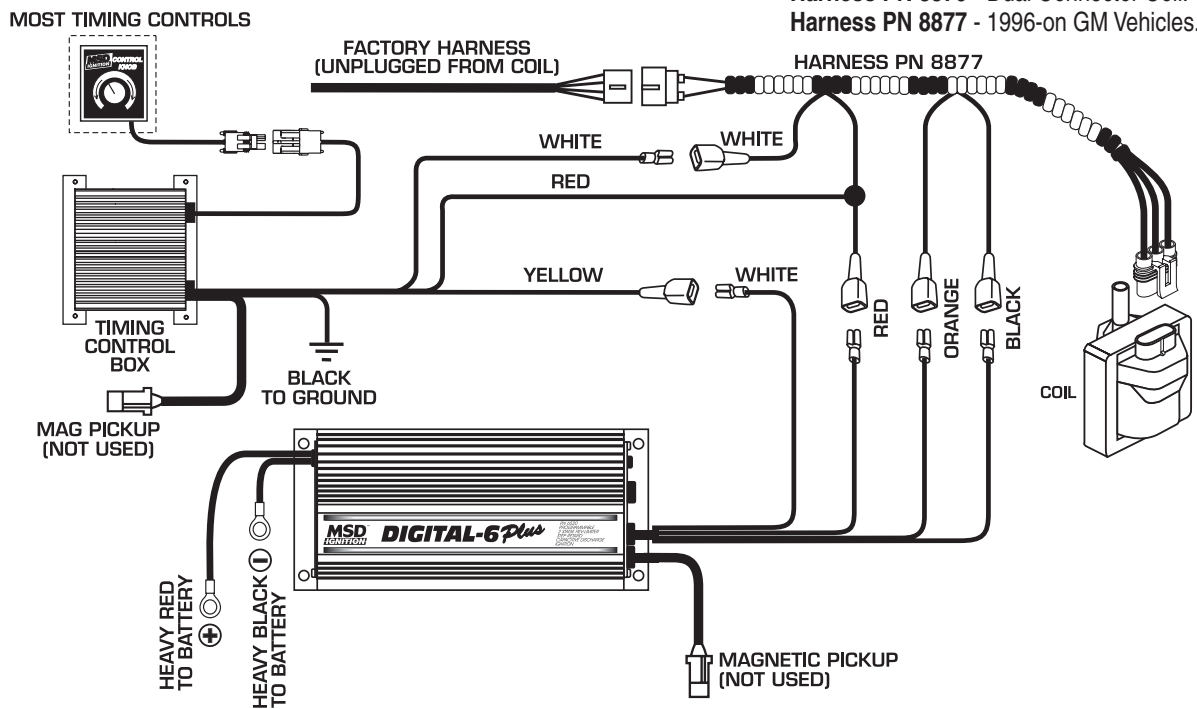

**GM IGNITIONS GM Large Cap HEI Distributors**

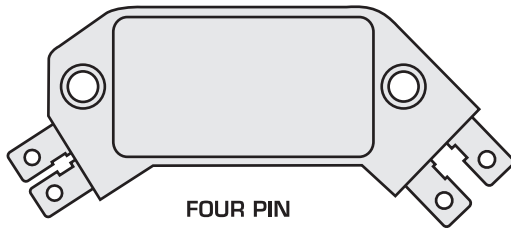

FOUR PIN

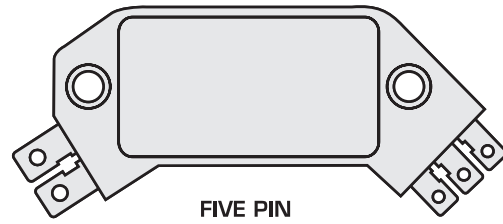

FIVE PIN



SEVEN PIN

There are three different large cap HEI distributors. To identify which of the following diagrams fit your specific application, remove the distributor cap and rotor and locate the ignition module at the base of the distributor. Count the number of terminals on both ends of the module and follow the corresponding diagram. GM used 4, 5, and 7-pin modules in these distributors.

**NOTE:** Some 5-pin models may experience a hesitation or stall on deceleration. If this occurs, contact MSD Tech Line for the required bolt-in diode to correct the problem. MSD Tech Line (915) 855-7123.

**GM IGNITIONS Wiring an HEI 4-pin Module (Magnetic Pickup Trigger).**

**NOTE:** The GM Ignition Module and condenser are removed and replaced with the MSD PN 8861 Harness.

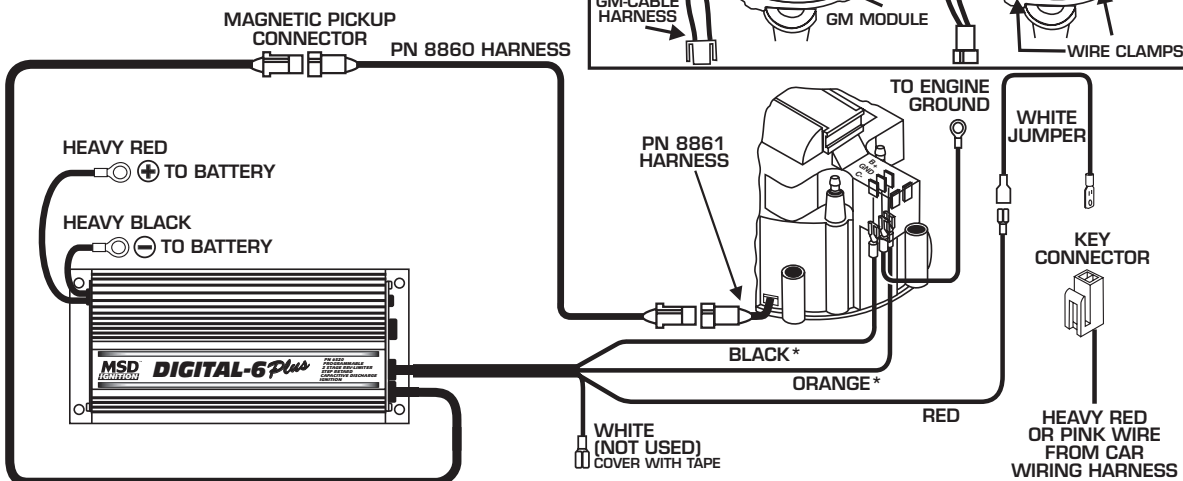
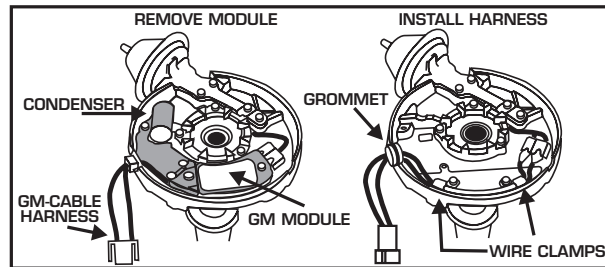

\*ORANGE - CONNECTS TO B+  
\*BLACK - CONNECTS TO C-

**GM IGNITIONS Wiring an HEI 5 or 7-pin Module (Amplifier Trigger).**

**NOTE:** Some 5-pin models may experience a hesitation or stall on deceleration. If this occurs, contact MSD Tech Line for the required bolt-in diode to correct the problem. MSD Tech Line (915) 855-7123.

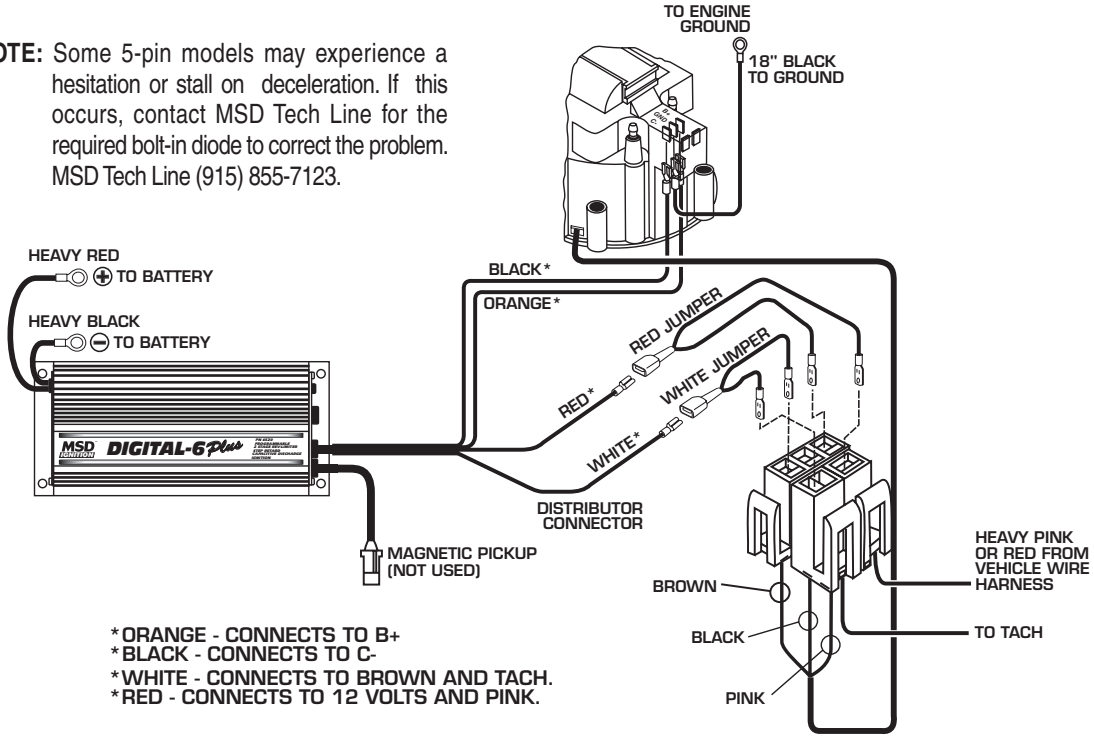

**FORD IGNITIONS Wiring a Ford DuraSpark using White Wire Trigger.**

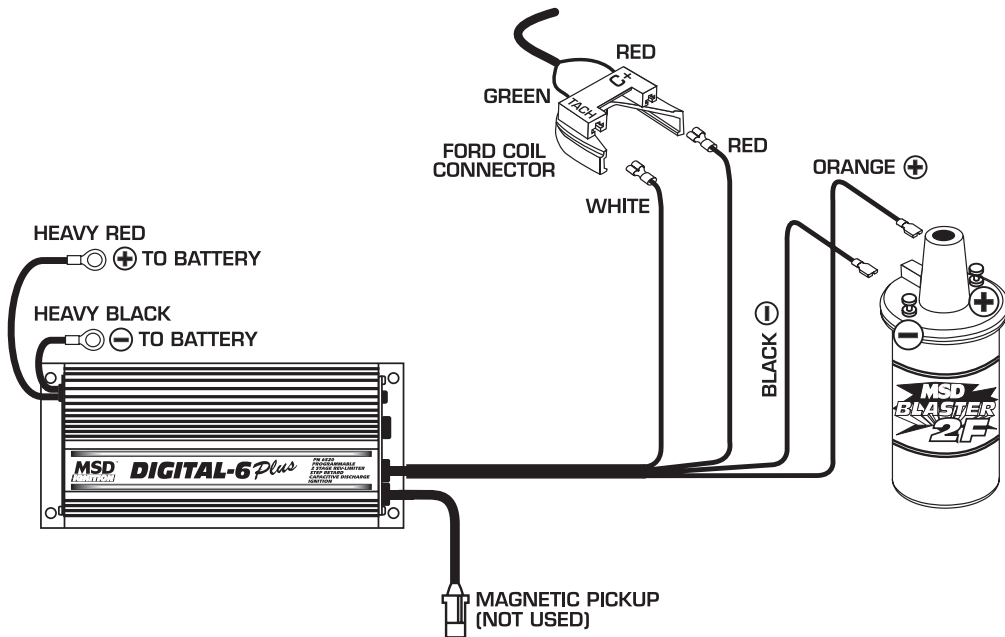

**FORD IGNITIONS** Wiring a Ford DuraSpark using Magnetic Pickup Trigger.

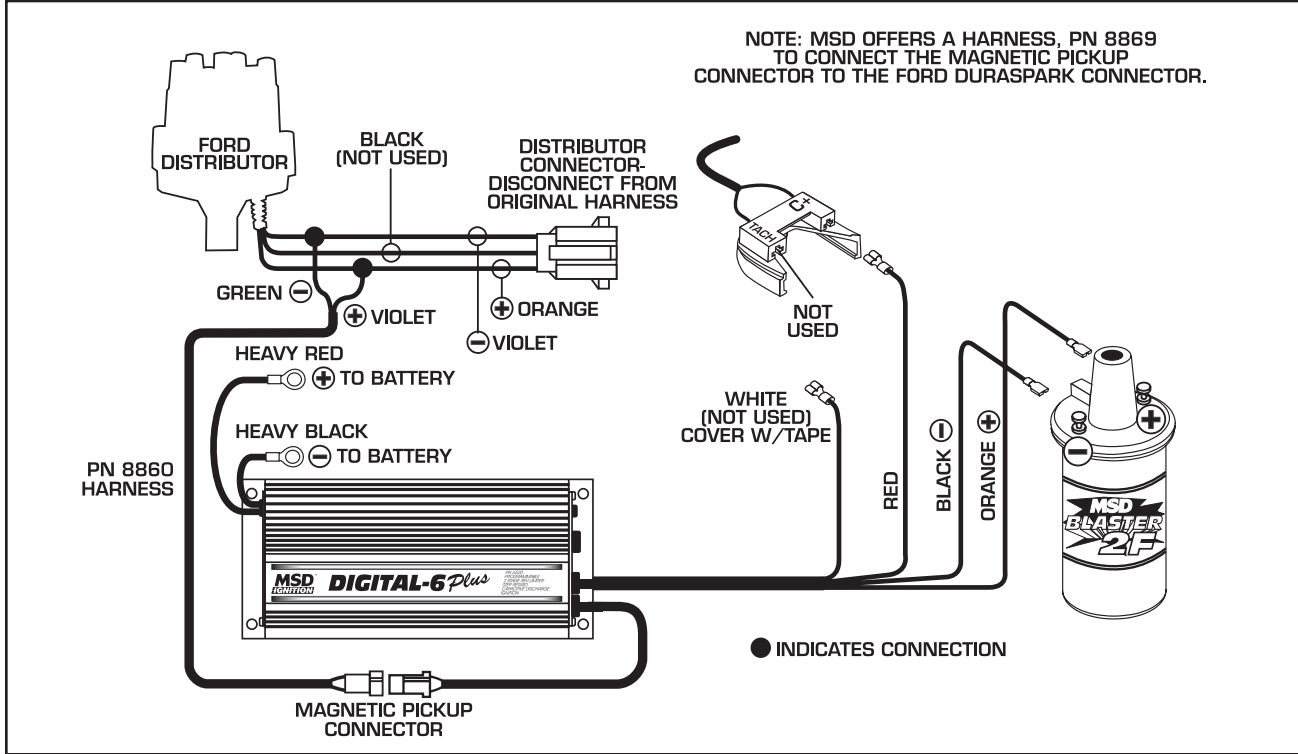

**FORD IGNITIONS** Wiring a Ford TFI (without Harness).

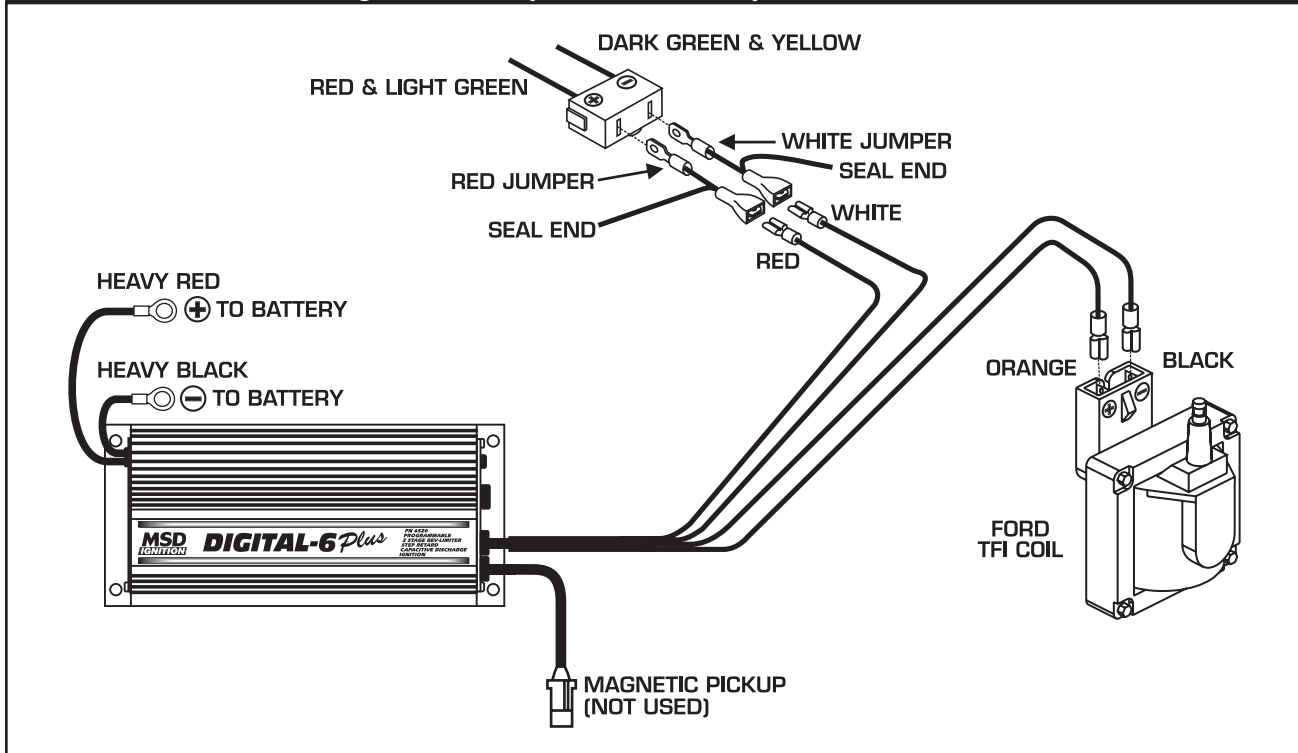



**FORD IGNITIONS Wiring a Ford TFI with Harness, PN 8874.**

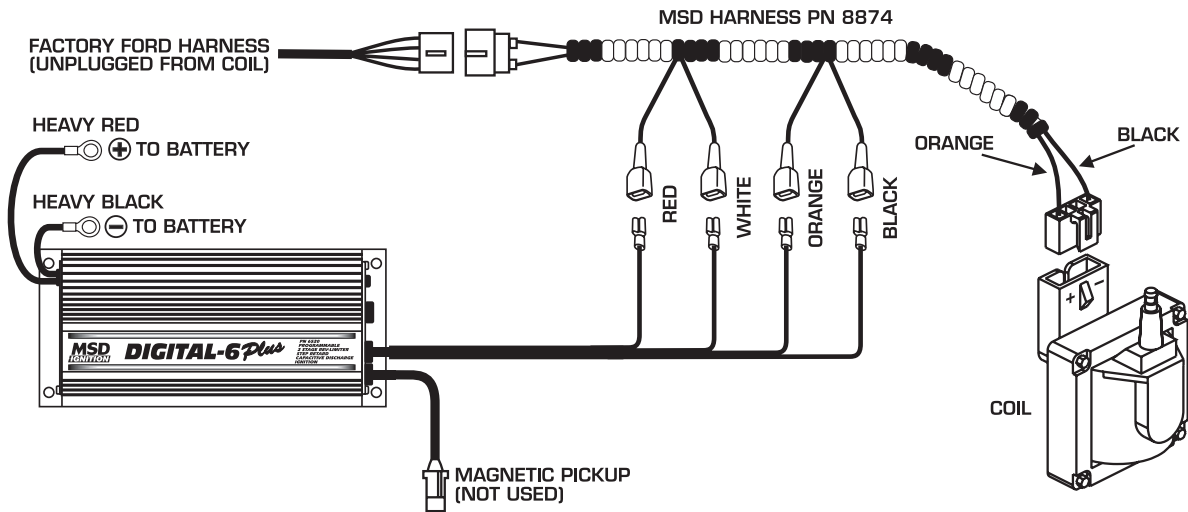

**NOTE:** Installation of a Timing Control with the Harness, see page 15.

**CHRYSLER IGNITIONS Wiring a Chrysler Electronic Ignition using Magnetic Pickup Trigger.**

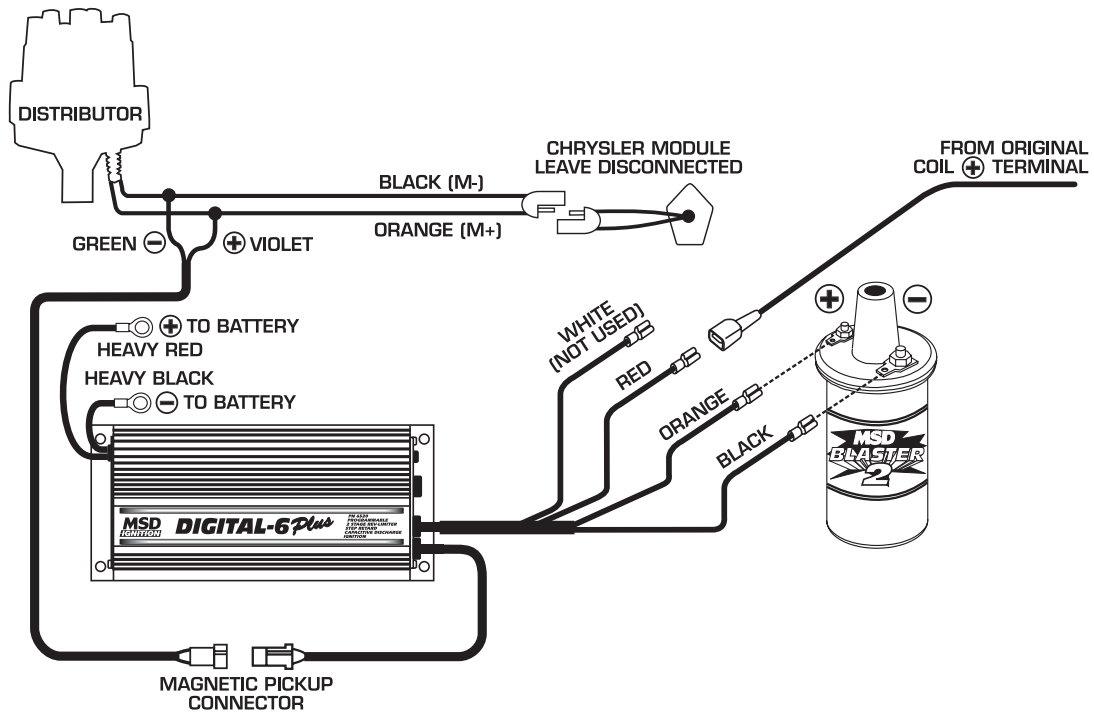

**CHRYSLER IGNITIONS** Wiring a Late Model Dodge with 2-pin connector.

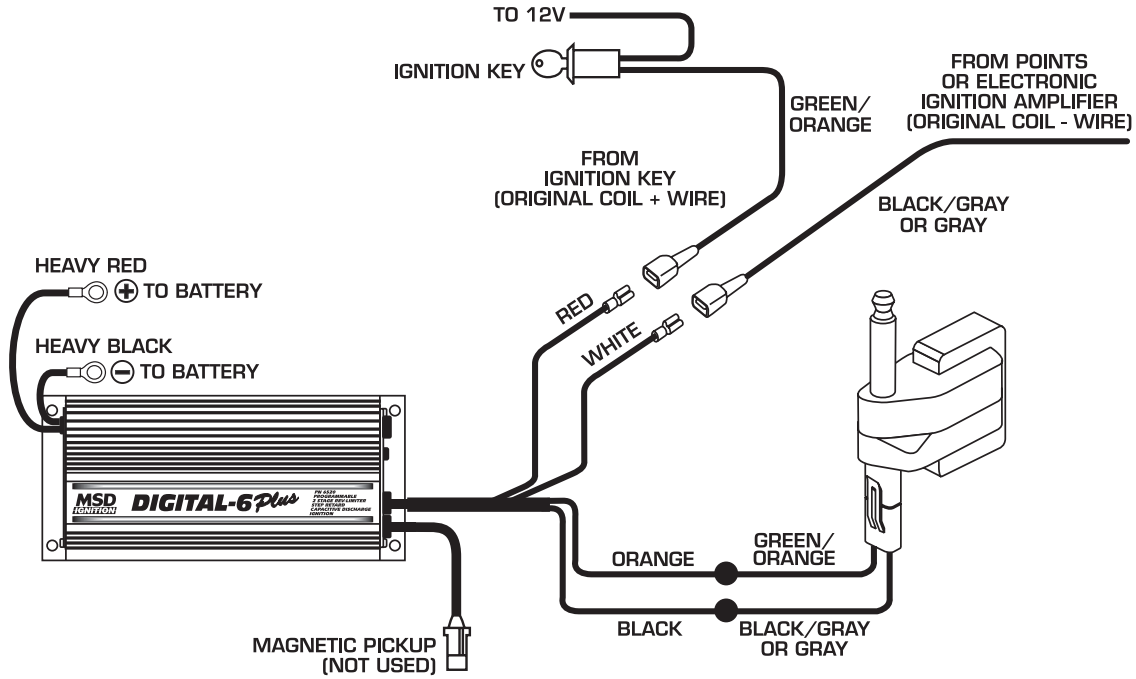

**CHRYSLER IGNITIONS** Wiring a Jeep with Integrated Coil/Module Assembly.

MSD offers a Wiring Kit, PN 8813, that allows you to modify the original Jeep Ignition Module/Coil assembly. This style of ignition is used in many 1987-1989 models. The drawing shows the installation with the coil already modified.

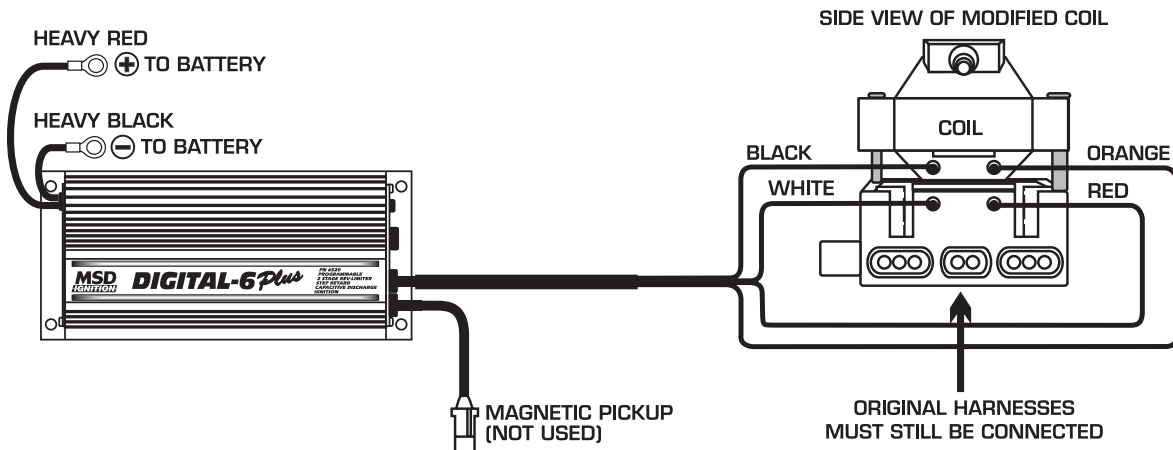

**HONDA IGNITIONS** Wiring a Honda with Internal Coil.

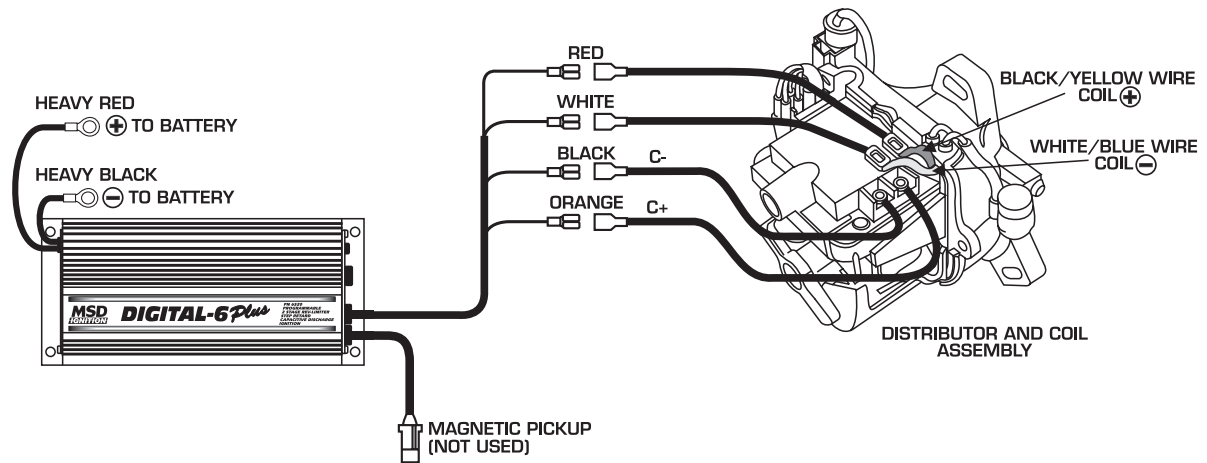

**HONDA IGNITIONS** Wiring a Honda with a Blaster Coil and Power Cap.

MSD offers a Power Cap to convert your internal coil Honda to external coil for most popular models.

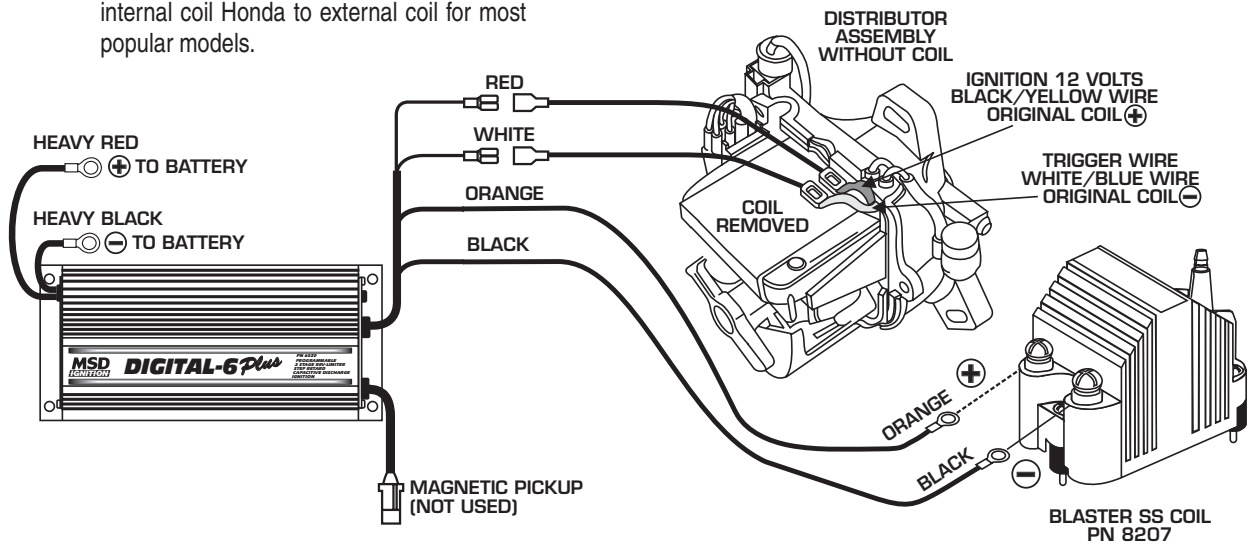

**HONDA IGNITIONS** Wiring a Factory External Coil Honda/Acura .

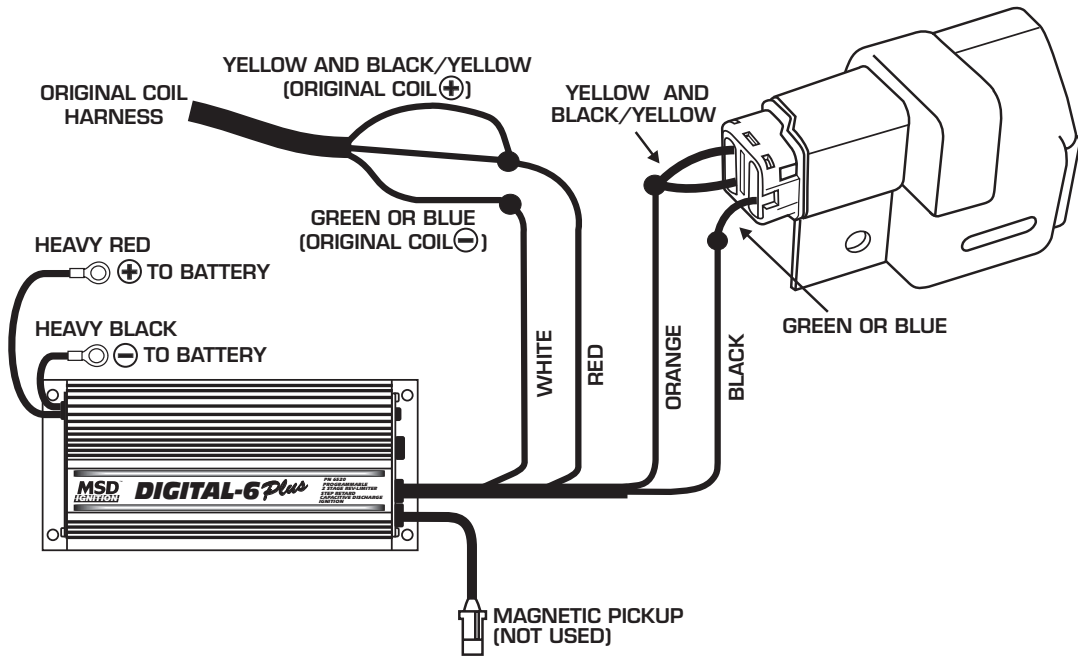

**GENERAL IMPORT WIRING**

**NOTE:** Remove the coil terminal wires. The negative wire connects to MSD White. The positive wire connects to MSD Red. The MSD Orange connects to the coil positive terminal, Black connects to the coil negative terminal.

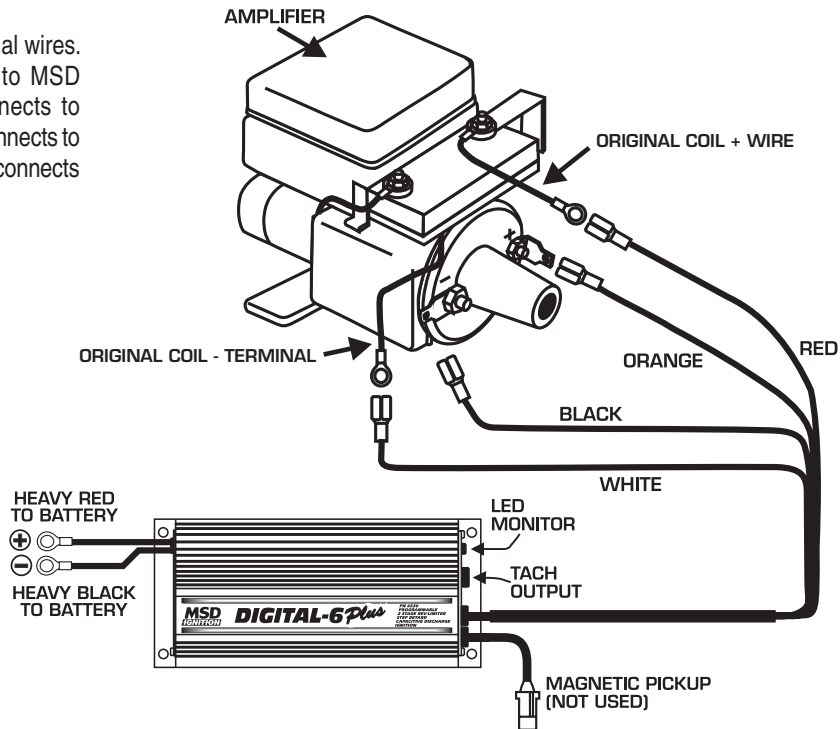

**AFTERMARKET COMPONENTS** Wiring a Mallory Unilite or 9000 Series using Points Trigger.

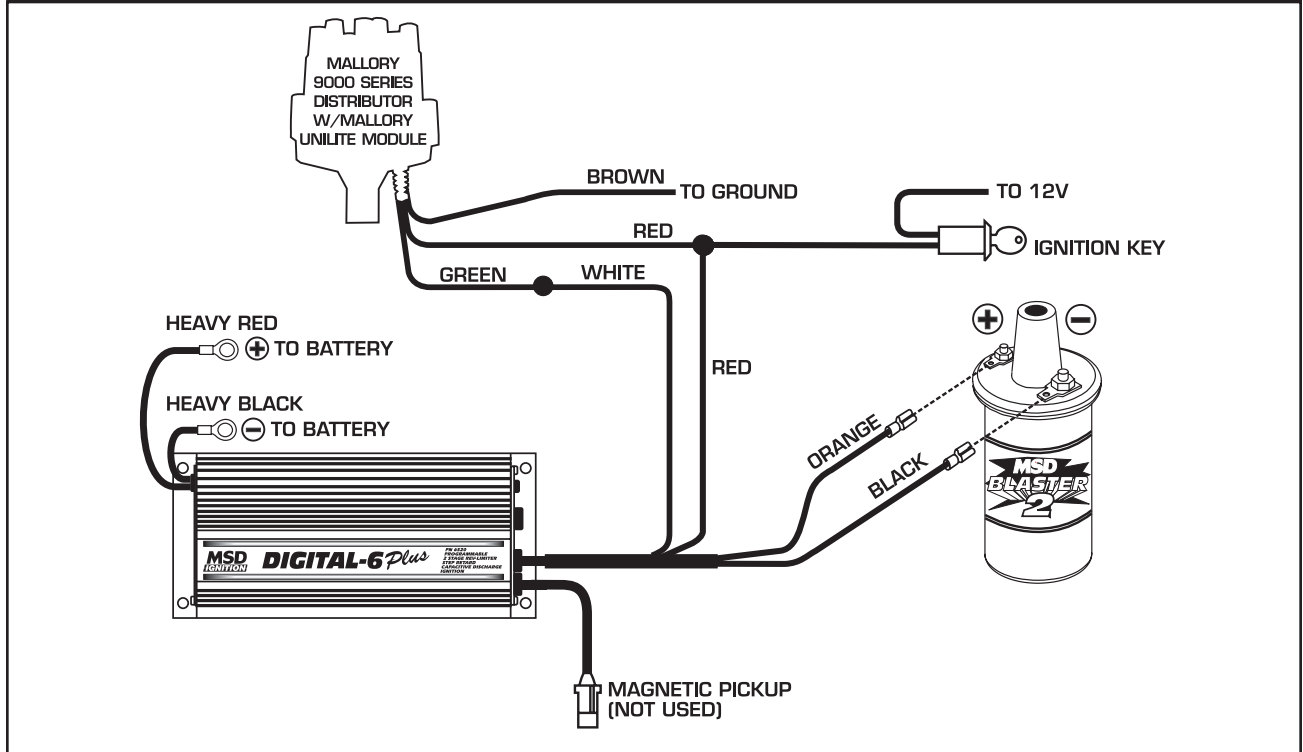

**AFTERMARKET COMPONENTS** Wiring a Mallory 9000 Series using Magnetic Pickup.

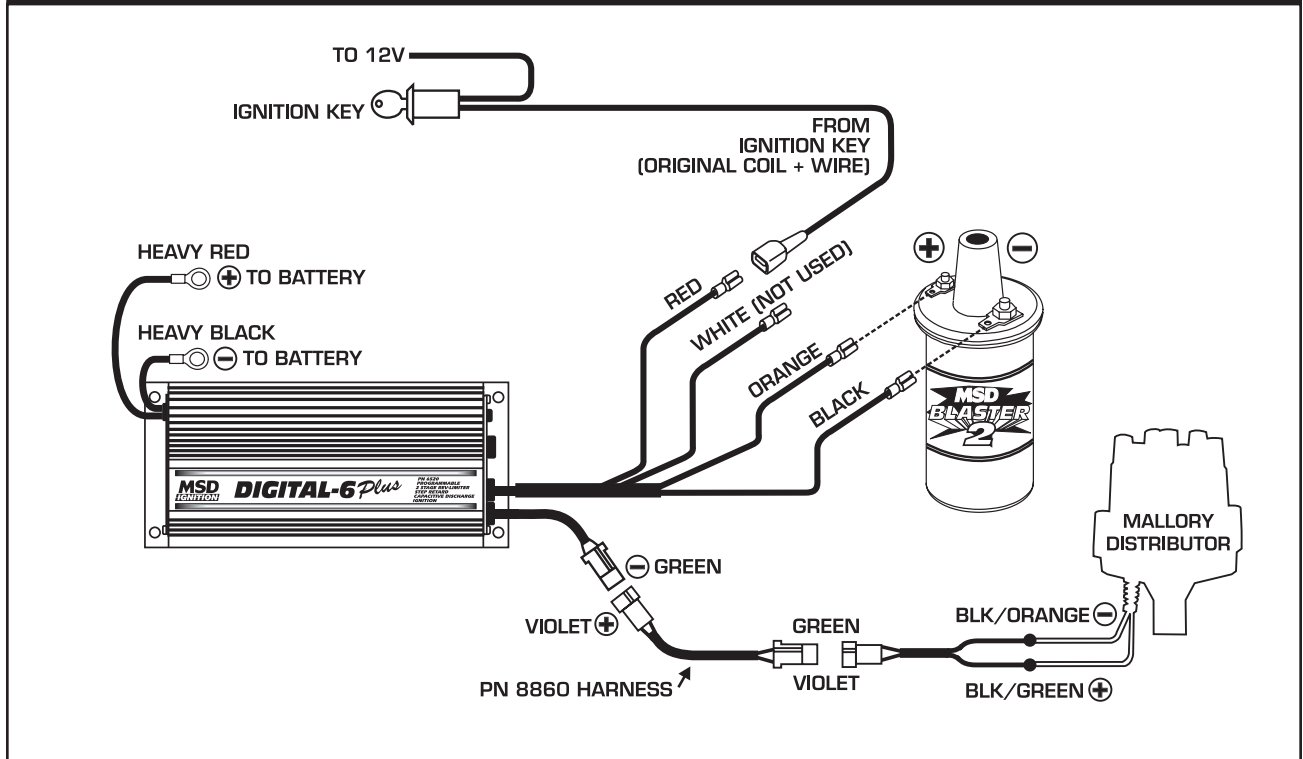



## AFTERMARKET COMPONENTS Wiring to a Pertronix Ignitor Kit.

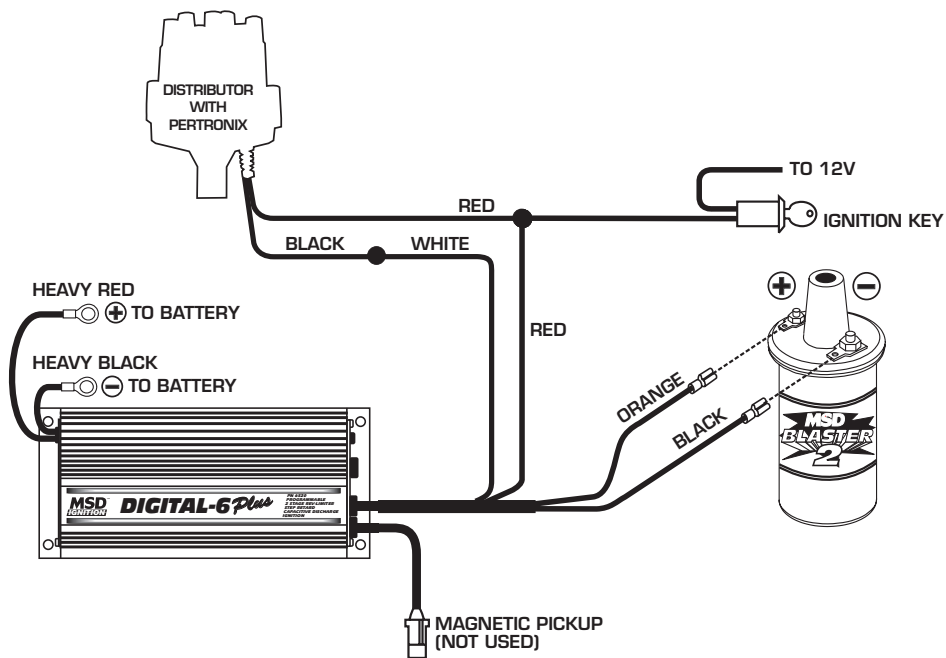

If you did not find a schematic to match your application, or if you need assistance, please contact MSD Tech at (915) 855-7123.

### Service

In case of malfunction, this MSD component will be repaired free of charge according to the terms of the warranty. When returning MSD components for warranty service, **Proof of Purchase** must be supplied for verification. After the warranty period has expired, repair service is based on a minimum and maximum fee.

**All returns must have a Return Material Authorization (RMA) number** issued to them before being returned. To obtain an RMA number please contact MSD Customer Service at 1 (888) MSD-7859 or visit our website at [www.msdpower.com/rma](http://www.msdpower.com/rma) to automatically obtain a number and shipping information.

When returning the unit for repair, leave all wires at the length in which you have them installed. Be sure to include a detailed account of any problems experienced, and what components and accessories are installed on the vehicle. The repaired unit will be returned as soon as possible using Ground shipping methods (ground shipping is covered by warranty). For more information, call MSD at (915) 855-7123. MSD technicians are available from 7:00 a.m. to 5:00 p.m. Monday - Friday (mountain time).

### Limited Warranty

MSD warrants this product to be free from defects in material and workmanship under its intended normal use\*, when properly installed and purchased from an authorized MSD dealer, for a period of one year from the date of the original purchase. This warranty is void for any products purchased through auction websites. If found to be defective as mentioned above, it will be repaired or replaced at the option of MSD. Any item that is covered under this warranty will be returned free of charge using Ground shipping methods.

This shall constitute the sole remedy of the purchaser and the sole liability of MSD. To the extent permitted by law, the foregoing is exclusive and in lieu of all other warranties or representation whether expressed or implied, including any implied warranty of merchantability or fitness. In no event shall MSD or its suppliers be liable for special or consequential damages.

\*Intended normal use means that this item is being used as was originally intended and for the original application as sold by MSD. Any modifications to this item or if it is used on an application other than what MSD markets the product, the warranty will be void. It is the sole responsibility of the customer to determine that this item will work for the application they are intending. MSD will accept no liability for custom applications.