



Helping Customers Innovate, Improve & Grow



VT-803

Description

Vectron's VT-803 Temperature Compensated Crystal Oscillator (TCXO) is a quartz stabilized, clipped sine wave or CMOS output, 5th order analog temperature compensated oscillator, operating off a 2.8 to 5.0 volt supply in a hermetically sealed 3.2x5 mm ceramic package.

Features

- Clipped Sine Wave or CMOS Output
- 10.000-52.000 MHz Output
- ±100 ppb Temperature Stability
- Enable/Disable Function
- Optional VCXO
- Fundamental Crystal Design
- Gold over nickel contact pads
- Hermetically Sealed Ceramic SMD package
- Product is compliant to RoHS directive  and fully compatible with lead free assembly

Applications

- Femto Cells
- Base Stations
- IP Networking
- GPS
- Point to Point Radio
- Manpack Radio
- Test and Measurement

Block Diagram

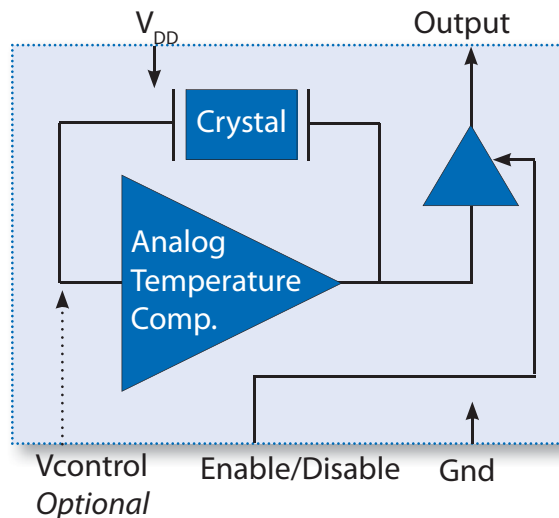

Specifications

Table 1. Electrical Performance, Clipped Sine Wave Option

Parameter	Symbol	Min	Typ	Max	Units
Output Frequency, ¹ <i>Ordering Option</i>	f_o	10		52	MHz
Supply Voltage ² , <i>Ordering Option</i>	V_{DD}	+2.8, +3.0, +3.3, +5.0			V
Supply Current, 10-26.000MHz 26.001-52.000MHz	I_{DD}			2.0 2.6	mA
Operating Temperature, <i>Ordering Option</i>	T_{OP}	-10/70, -20/70, -30/85, -40/85			°C
Stability Over Operating Temperature ³ , <i>Ordering Option</i>		±0.100, ±0.200, ±0.280, ±0.500, ±1.0			ppm
Initial Accuracy, "No Adjust" Option ⁴				±1.0	ppm
Power Supply Stability, ±5% change				±0.05	ppm
Load Stability, ±10% change				±0.05	ppm
Aging				±0.5	ppm/yr
Pull Range, <i>Ordering Option</i>	PR	±5, ±8, ±10, ±12			ppm
Control Voltage to reach Pull Range		0.5		2.5	V
Control Voltage Impedance		100			Kohm
Output Level	V_o p/p	0.8			V
Output Load				10K 10pF	
Phase Noise, 26.000MHz 10Hz 100Hz 1kHz 10kHz 100kHz	ϕ_N		-91 -117 -136 -150 -158		dBc/Hz
Enable/ Disable ⁵ Output Enabled Output Disabled	V_{IH} V_{IL}	$0.3 * V_{DD}$		$0.7 * V_{DD}$	V V
Start Up Time	t_{SU}			2	ms

1. The Output is DC coupled.
2. The VT-803 power supply pin should be filtered, eg, a 10uF, 0.1uF and 0.01uf capacitor.
3. Not all stabilities are available over all temperature ranges, consult Table 9.
4. After 2 IR reflows and 24 hours.
5. The output is enabled if the E/D is left floating.

Outline Drawing

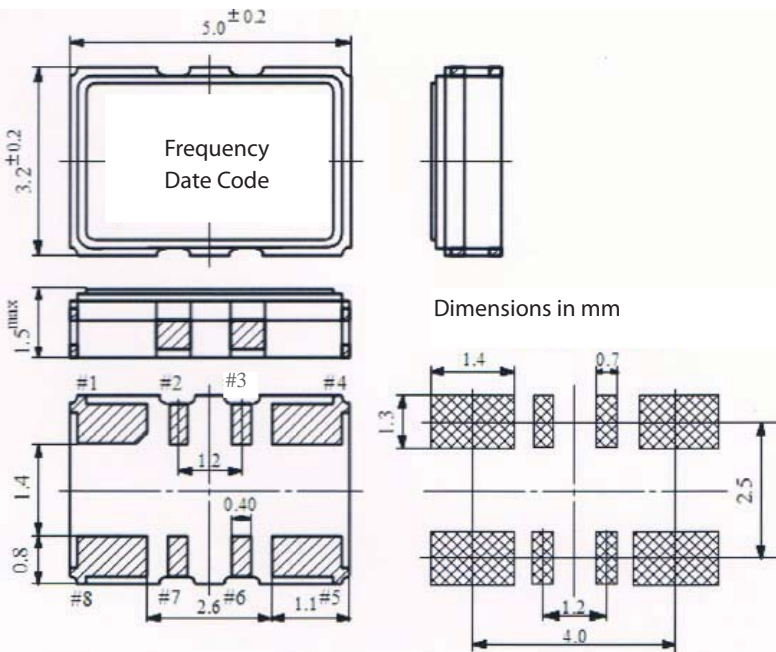

Table 2. Pinout

Pin #	Symbol	Function
1	V_c	TCXO Control Voltage or NC
2	NC	Make No Connection
3	NC	Make No Connection
4	GND	Ground
5	OUT	Output
6	E/D	Enable Disable
7	NC	Make No Connection
8	V_{DD}	Supply Voltage

Specifications

Table 3. Electrical Performance, CMOS Option					
Parameter	Symbol	Min	Typ	Max	Units
Output Frequency ¹ , <i>Ordering Option</i>	f_o	10		52	MHz
Supply Voltage ² , <i>Ordering Option</i>	V_{DD}	+2.8, +3.0, +3.3, +5.0			V
Supply Current, 10-26MHz 26.001-40.000MHz 40.001- 52.000MHz	I_{DD}			3.5 5 6	mA
Operating Temperature, <i>Ordering Option</i>	T_{OP}	-10/70, -20/70, -30/85, -40/85			°C
Stability Over Operating Temperature ³ , <i>Ordering Option</i>		$\pm 0.100, \pm 0.200 \pm 0.280 \pm 0.500, \pm 1.0, \pm 2.0$			ppm
Initial Accuracy, "No Adjust" Option ³				± 1.0	ppm
Power Supply Stability, $\pm 5\%$ change				± 0.05	ppm
Load Stability, $\pm 10\%$ change				± 0.05	ppm
Aging				± 0.5	ppm/yr
Pull Range, <i>Ordering Option</i>	PR	$\pm 5, \pm 8, \pm 10, \pm 12$			ppm
Control Voltage to reach Pull Range		0.5		2.5	V
Control Voltage Impedance		100			Kohm
Output Level Output Logic High Output Logic Low Output Logic High Drive Output Logic Low Drive	V_{OH} V_{OL} I_{OH} I_{OL}	$0.9 * V_{DD}$ 4		$0.1 * V_{DD}$ -4	V V mA mA
Output Load				15	pF
Phase Noise, 26.000MHz 10Hz 100Hz 1kHz 10kHz 100kHz	\emptyset_N		-91 -117 -139 -153 -157		dBc/Hz
Period Jitter ⁵ rms peak-peak			2.5 21.0		ps ps
Enable/ Disable ⁶ Output Enabled Output Disabled	V_{IH} V_{IL}	$0.3 * V_{DD}$		$0.7 * V_{DD}$	V V
Start Up Time	t_{SU}			2	ms

1. The Output is DC coupled.
2. The VT-803 power supply pin should be filtered, eg, a 10uF, 0.1 uF and 0.01 uf capacitor.
3. Not all stabilities are available over all temperatures, consult Table 10.
4. After 2 IR reflows and 24 hours.
5. Measured using a Wavecrest SIA3300C, 90K samples.
6. The output is enabled if the E/D is left floating.

Warm Up Time

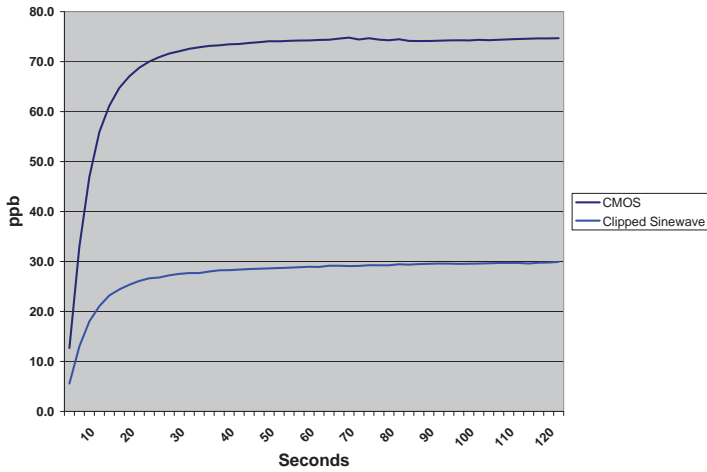

Figure 1

The VT-803 start up time is rated at 2ms. Figure 1 shows the Output Frequency versus time in seconds which shows the output reaching a steady state frequency within 60 seconds.

Frequency versus Vc Over Temperature

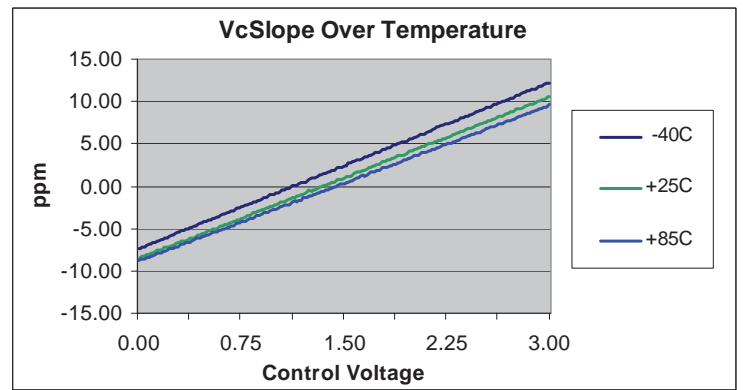

Figure 2

The VT-803 output frequency change versus control voltage is very linear and Figure 2 show the typical performance over temperature.

Allan Deviation, Clipped Sine Wave Output

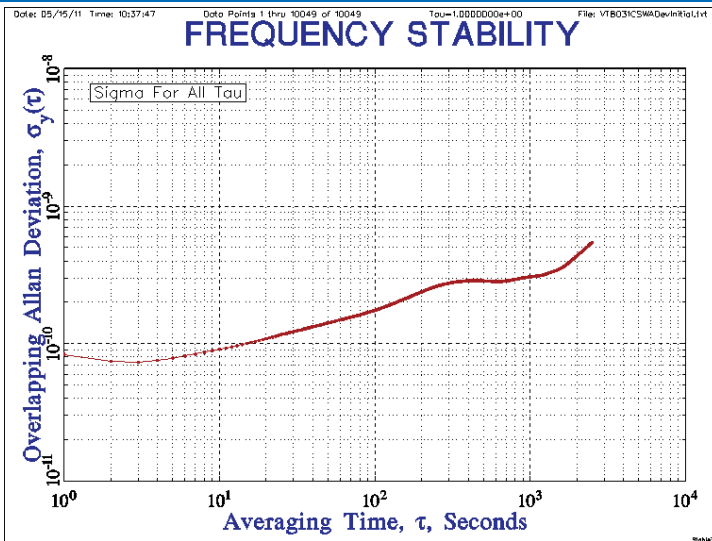

Figure 3

Test Conditions are under room ambient air flow (non insulated conditions).

Allan Deviation, CMOS Output

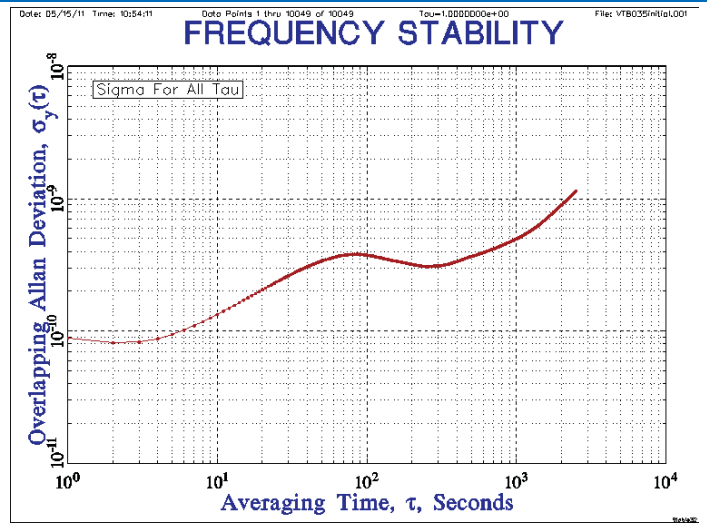

Figure 4

Test Conditions are under room ambient air flow (non insulated conditions).

Aging

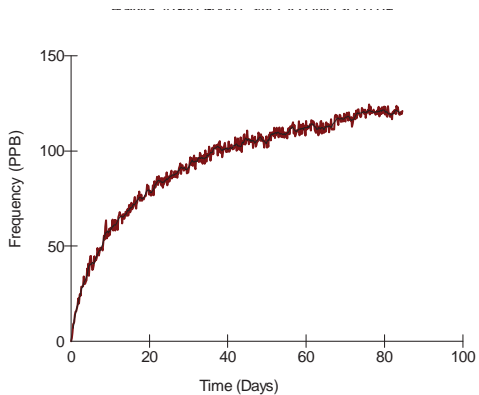

Figure 5

Figure 5 shows an output frequency change of 125ppb typical over 85 days at 85°C which would be equivalent to 125ppb over 2.25 years at 40°C.

Delta 1 Second Frequency

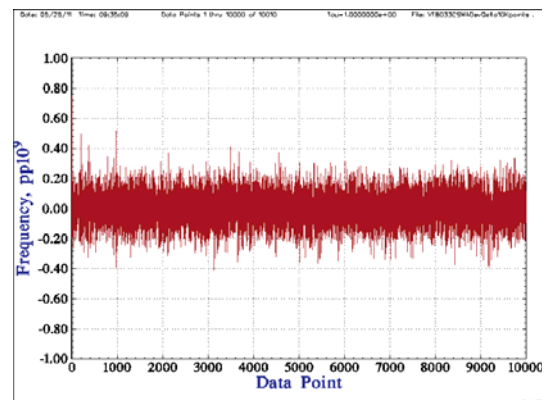
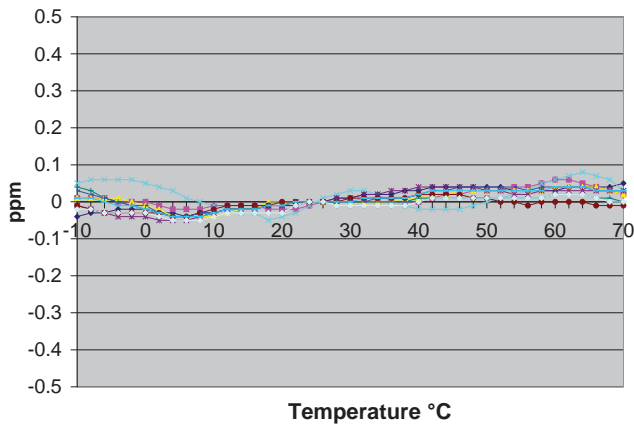

Figure 6

Figure 6 is a plot of the change in frequency, in ppm, between 1 second readings for 10K data points.

Temperature Stability Graph



Temperature °C
Figure 7

Delta Frequency vs. Temperature

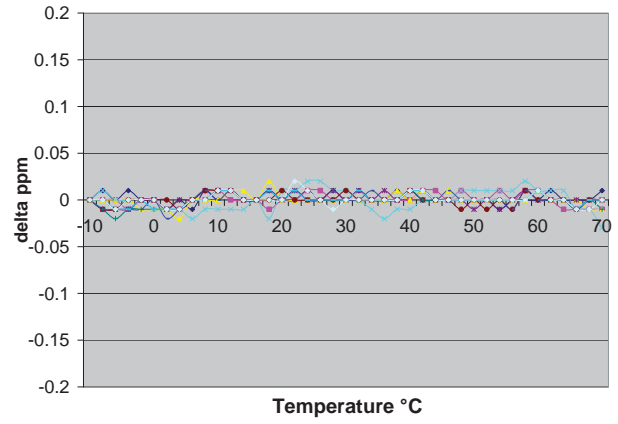

Figure 8

Figure 8 shows the change in frequency reading between every adjacent 2°C readings.

Phase Noise Performance, Clipped Sine Wave

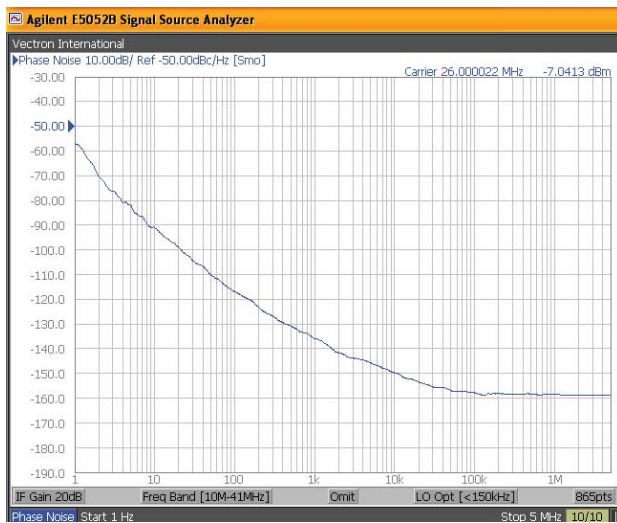

Figure 9

Phase Noise Performance, CMOS

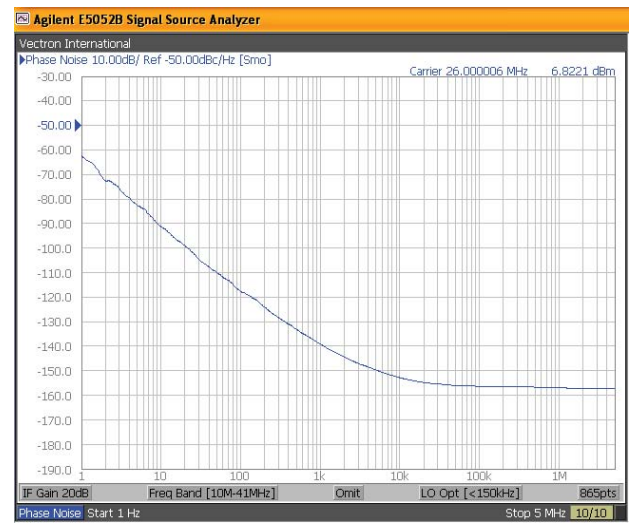

Figure 10

Phase Noise Over Temperature

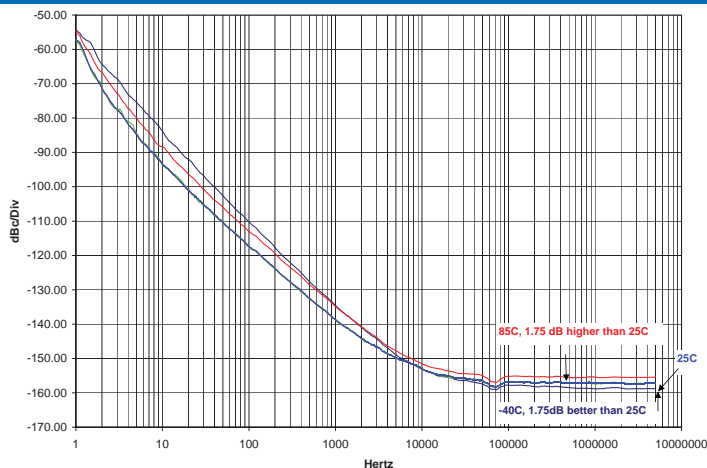

Figure 11

Figure 11 shows the difference in the phase noise at 85°C, 25°C and -40°C.

Phase Noise Over Power Supply Variation

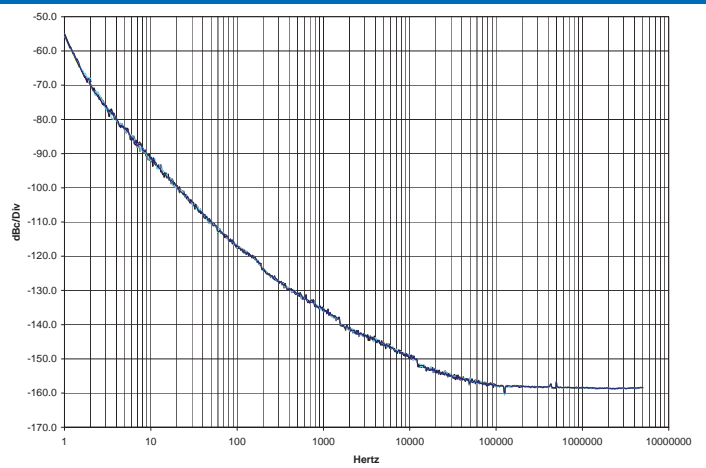

Figure 12

Figure 12 is a phase noise plot at a 2.8, 3.0, 3.3 and 3.6 volt power supply which demonstrates there is no significant change in performance.

VCXO Function

VCXO Feature: The VT-803 is supplied with a VCXO function for applications where it will be used in a PLL, or the output frequency needs fine tune or calibration adjustments. This is a high impedance input, 100 Kohm, and can be driven with an op-amp or terminated with adjustable resistors etc. **Pin 1 should not be left floating on the VCXO optional device.**

Maximum Ratings

Absolute Maximum Ratings and Handling Precautions

Stresses in excess of the absolute maximum ratings can permanently damage the device. Functional operation is not implied or any other excess of conditions represented in the operational sections of this data sheet. Exposure to absolute maximum ratings for extended periods may adversely affect device reliability.

Although ESD protection circuitry has been designed into the VT-803, proper precautions should be taken when handling and mounting. VI employs a Human Body Model and Charged Device Model for ESD susceptibility testing and design evaluation. ESD thresholds are dependent on the circuit parameters used to define the model. Although no industry standard has been adopted for the CDM a standard resistance of 1.5kOhms and capacitance of 100pF is widely used and therefore can be used for comparison purposes.

Parameter	Symbol	Rating	Unit
Storage Temperature	T_{STORE}	-55/125	°C
Supply Voltage	V_{DD}	-0.6/6	V
Control Voltage	V_C	$-0.6/V_{DD}+0.6$	V
Enable/Disable Voltage	E/D	$-0.6/V_{DD}+0.6$	V
ESD, Human Body Model		1500	V
ESD, Charged Device Model		1000	V

Reliability

Parameter	Condition
Mechanical Shock	MIL-STD-883 Method 2002
Mechanical Vibration	MIL-STD-883 Method 2007
Temperature Cycle	MIL-STD-883 Method 1010
Solderability	MIL-STD-883 Method 2003
Fine and Gross Leak	MIL-STD-883 Method 1014
Resistance to Solvents	MIL-STD-883 Method 2015
Moisture Sensitivity Level	MSL1
Contact Pads	Gold over Nickel

IR Reflow

Suggested IR Profile

Devices are built using lead free epoxy and can be subjected to standard lead free IR reflow conditions shown in Table 5. Contact pads are gold over nickel and lower maximum temperatures can also be used, such as 220°C.

Table 6. Reflow Profile		
Parameter	Symbol	Value
PreHeat Time Ts-min Ts-max	t_s	200 sec Max 150°C 200°C
Ramp Up	R_{UP}	3°C/sec Max
Time above 217C	t_L	150 sec Max
Time to Peak Temperature	$t_{25C \text{ to peak}}$	480 sec Max
Time at 260C	t_p	30 sec Max
Time at 240C	t_{p2}	60 sec Max
Ramp down	R_{DN}	6°C/sec Max

Solderprofile:

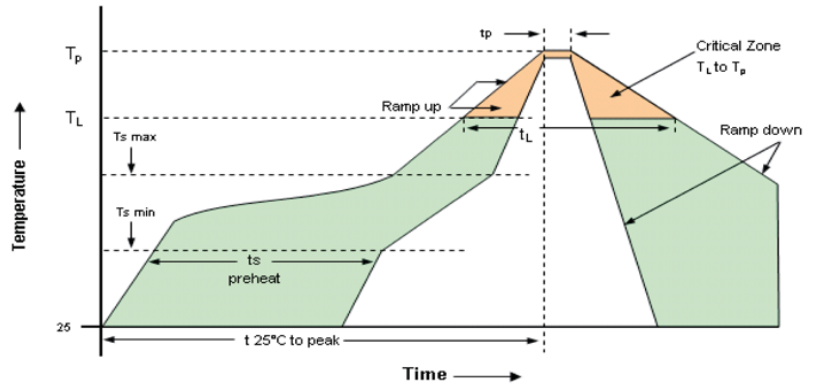

Tape & Reel

Table 7. Tape and Reel Information

Tape Dimensions (mm)						Reel Dimensions (mm)						
W	F	Do	Po	P1	A	B	C	D	N	W1	W2	#/Reel
12	5.5	1.5	4	8	254	2.5	13	21	100	13.5	17.5	2000

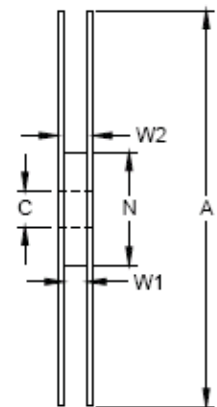
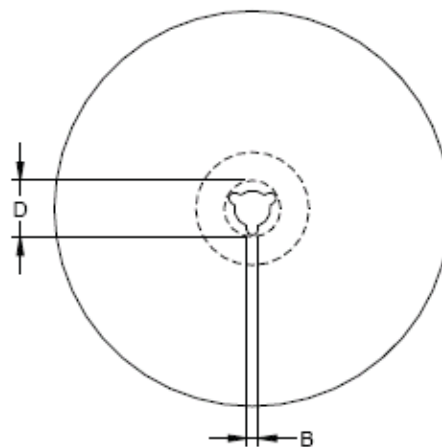
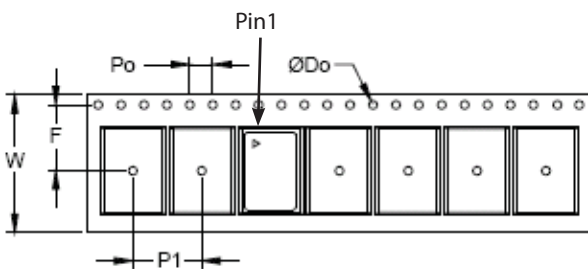

Ordering Information

Table 8. Standard Frequencies (MHz)

10.000	12.800	16.000	16.384	19.200	20.000	20.480	25.000	26.000	28.800
40.000	50.000								

VT-803- E A H - 507A- xxMxxxxxxxx

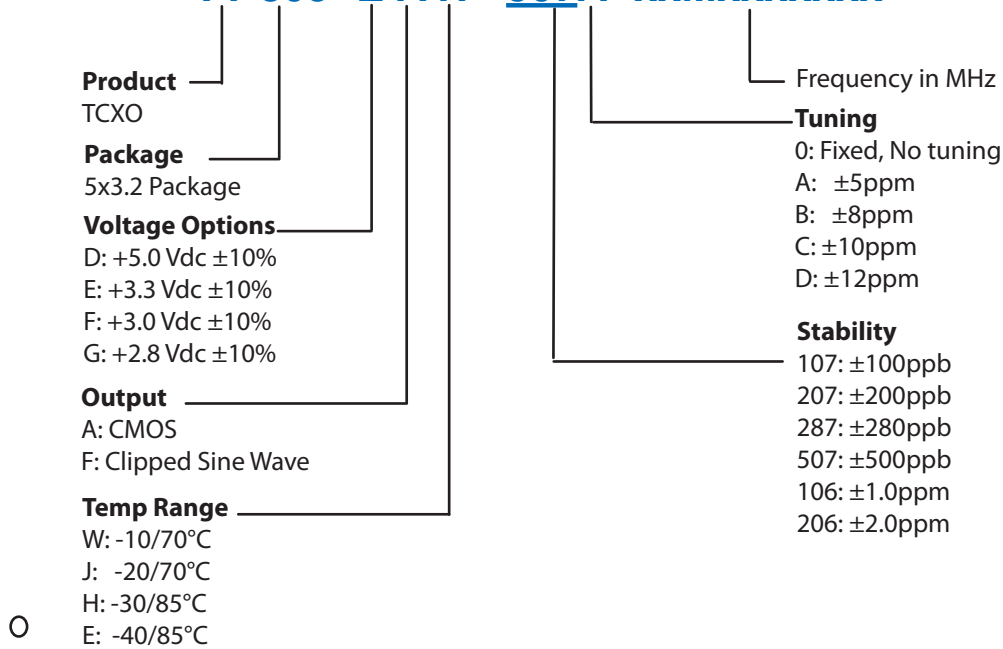

Table 9. Capabilities, Clipped Sine Wave Output

	100ppb	200ppb	280ppb	500ppb	1ppm
-10/70°C	●	●	●	●	●
-20/70°C		●	●	●	●
-30/85°C		●	●	●	●
-40/85°C		●	●	●	●

Table 10. Capabilities, CMOS Output

	100ppb	200ppb	280ppb	500ppb	1ppm	2ppm
-10/70°C	●	●	●	●	●	●
-20/70°C		●	●	●	●	●
-30/85°C		●	●	●	●	●
-40/85°C		●	●	●	●	●

- = Can be provided.
- = Under development.
- Blank = Can not be provided.

USA:

Vectron International
267 Lowell Road
Hudson, NH 03051
Tel: 1.888.328.7661
Fax: 1.888.329.8328

Europe:

Vectron International
Landstrasse, D-74924
Neckarbischofsheim, Germany
Tel: +49 (0) 3328.4784.17
Fax: +49 (0) 3328.4784.30

Asia:

VI Shanghai
1589 Century Avenue, the 19th Floor
Chamtime International Financial Center
Shanghai, China
Tel: 86.21.6081.2888
Fax: 86.21.6163.3598