

**800mA LOW DROPOUT LINEAR REGULATOR****AZ1117B****General Description**

The AZ1117B is a low dropout three-terminal regulator with a dropout of 1.2V at 800mA output current.

The AZ1117B has been optimized for low voltage where transient response and minimum input voltage are critical. It provides current limit and thermal shutdown. Its circuit includes a trimmed bandgap reference to assure output voltage accuracy to be within $\pm 1\%$. On-chip thermal shutdown provides protection against a combination of high current and ambient temperature that would create excessive junction temperature.

The AZ1117B is available in 1.8V, 2.5V and 3.3V versions. The fixed versions integrate the adjust resistors. It is also available in an adjustable version which can set the output voltage with two external resistors.

The AZ1117B is available in the industry-standard SOT-223 power package.

Features

- Low Dropout Voltage: 1.2V at 800mA Output Current
- Output Noise from 10Hz to 10KHz: 0.003% of V_{OUT}
- PSRR at $I_{OUT}=300mA$ and $f=120Hz$: 70dB
- Output Voltage Accuracy: $\pm 1\%$
- On-chip Thermal Shutdown
- Maximum Quiescent Current: $I_{QMAX}=6mA$
- Operation Junction Temperature: -20 to 105°C

Applications

- USB Device
- Add-on Card
- DVD Player
- PC Motherboard

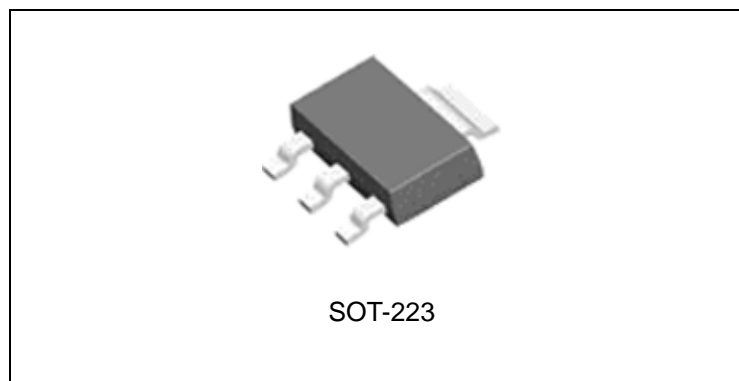

Figure 1. Package Type of AZ1117B



800mA LOW DROPOUT LINEAR REGULATOR

AZ1117B

Pin Configuration

H Package
(SOT-223)

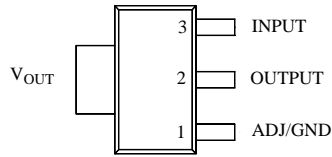

Figure 2. Pin Configuration of AZ1117B (Top View)

Functional Block Diagram

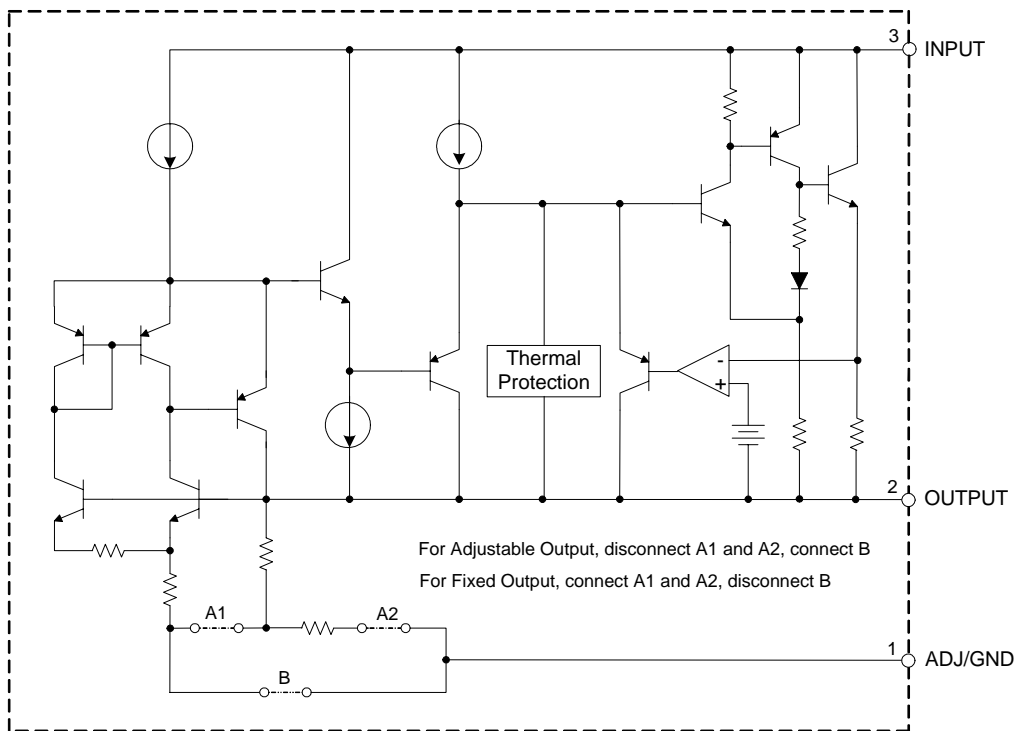

Figure 3. Functional Block Diagram of AZ1117B



800mA LOW DROPOUT LINEAR REGULATOR

AZ1117B

Ordering Information

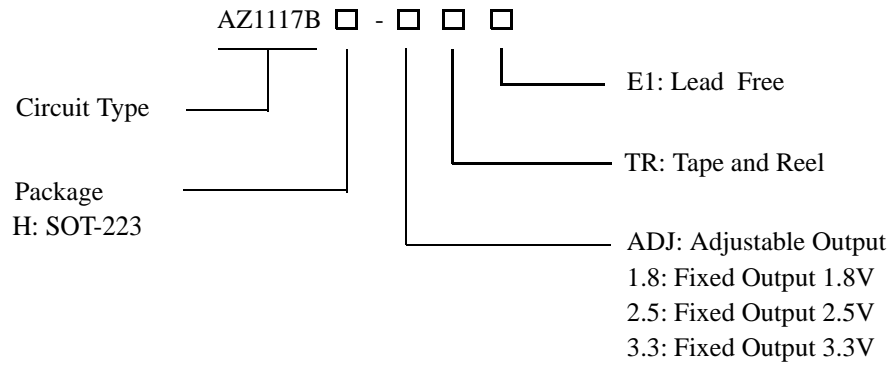

Package	Temperature Range	Part Number	Marking ID	Packing Type
SOT-223	-20 to 105°C	AZ1117BH-ADJTRE1	EH17K	Tape & Reel
		AZ1117BH-1.8TRE1	EH17L	Tape & Reel
		AZ1117BH-2.5TRE1	EH17N	Tape & Reel
		AZ1117BH-3.3TRE1	EH17M	Tape & Reel

BCD Semiconductor's Pb-free products, as designated with "E1" suffix in the part number, are RoHS compliant.

**800mA LOW DROPOUT LINEAR REGULATOR****AZ1117B****Absolute Maximum Ratings (Note 1)**

Parameter	Symbol	Value	Unit
Input Voltage	V_{IN}	18	V
Operating Junction Temperature Range	T_J	150	°C
Storage Temperature Range	T_{STG}	-65 to 150	°C
Lead Temperature (Soldering, 10sec)	T_{LEAD}	260	°C

Note 1: Stresses greater than those listed under "Absolute Maximum Ratings" may cause permanent damage to the device. These are stress ratings only, and functional operation of the device at these or any other conditions beyond those indicated under "Recommended Operating Conditions" is not implied. Exposure to "Absolute Maximum Ratings" for extended periods may affect device reliability.

Recommended Operating Conditions

Parameter	Symbol	Min	Max	Unit
Input Voltage	V_{IN}		12	V
Operating Junction Temperature Range	T_J	-20	105	°C



800mA LOW DROPOUT LINEAR REGULATOR

AZ1117B

Electrical Characteristics

AZ1117B-ADJ Electrical Characteristics

Operating Conditions: $V_{IN}=V_{OUT}+2V$, $I_{OUT}=10mA$, $T_J=25^{\circ}C$, unless otherwise specified. ($P \leq$ maximum power dissipation).

Limits appearing in **Boldface** type apply over the entire junction temperature range for operation, $-20^{\circ}C$ to $105^{\circ}C$.

Parameter	Symbol	Conditions	Min	Typ	Max	Unit
Reference Voltage	V_{REF}		1.238	1.250	1.262	V
		$10mA \leq I_{OUT} \leq 800mA$, $1.5V \leq V_{IN} - V_{OUT} \leq 10V$	1.225	1.250	1.270	
Line Regulation	V_{RLINE}	$1.5V \leq V_{IN} - V_{OUT} \leq 10V$		0.001	0.1	%
					0.2	
Load Regulation	V_{RLOAD}			0.4	1.0	%
Dropout Voltage	V_{DROP}	$\Delta V_{REF}=1\%$, $I_{OUT}=0.8A$		1.2	1.3	V
Current Limit	I_{LIMIT}		0.85	1	1.15	A
Adjust Pin Current				60	120	μA
Adjust Pin Current Change		$1.5V \leq (V_{IN} - V_{OUT}) \leq 10V$, $10mA \leq I_{OUT} \leq 800mA$		0.2	5	μA
Minimum Load Current		$1.5V \leq (V_{IN} - V_{OUT}) \leq 10V$		1.7	5	mA
Ripple Rejection	PSRR	$f=120Hz$, $C_{OUT}=22\mu F$ $(V_{IN} - V_{OUT})=3V$, $I_{OUT}=300mA$		70		dB
Temperature Stability				0.5		%
RMS Output Noise (% of V_{OUT})		$T_A=25^{\circ}C$, $10Hz \leq f \leq 10KHz$		0.003		%
Thermal Shutdown		Junction Temperature		160		$^{\circ}C$
Thermal Shutdown Hysteresis				16		$^{\circ}C$



800mA LOW DROPOUT LINEAR REGULATOR

AZ1117B

Electrical Characteristics (Continued)

AZ1117B-1.8 Electrical Characteristics

Operating Conditions: $V_{IN}=3.8V$, $I_{OUT}=10mA$, $T_J=25^{\circ}C$, unless otherwise specified. ($P \leq$ maximum power dissipation). Limits appearing in **Boldface** type apply over the entire junction temperature range for operation, $-20^{\circ}C$ to $105^{\circ}C$.

Parameter	Symbol	Conditions	Min	Typ	Max	Unit
Output Voltage	V_{OUT}		1.782	1.8	1.818	V
		$10mA \leq I_{OUT} \leq 800mA$, $3.8V \leq V_{IN} \leq 10V$	1.764	1.8	1.836	
Line Regulation	V_{RLINE}	$1.5V \leq V_{IN} - V_{OUT} \leq 10V$		0.5	6	mV
					10	
Load Regulation	V_{RLOAD}			2	15	mV
Dropout Voltage	V_{DROP}	$\Delta V_{OUT}=1\%$, $I_{OUT}=0.8A$		1.2	1.3	V
Current Limit	I_{LIMIT}		0.85	1	1.15	A
Quiescent Current	I_Q	$I_{OUT}=0$		4	6	mA
Ripple Rejection	PSRR	$f=120Hz$, $C_{OUT}=22\mu F$ $(V_{IN}-V_{OUT})=3V$, $I_{OUT}=300mA$		70		dB
Temperature Stability				0.5		%
RMS Output Noise (% of V_{OUT})		$T_A=25^{\circ}C$, $10Hz \leq f \leq 10KHz$		0.003		%
Thermal Shutdown		Junction Temperature		160		$^{\circ}C$
Thermal Shutdown Hysteresis				16		$^{\circ}C$

**800mA LOW DROPOUT LINEAR REGULATOR****AZ1117B****Electrical Characteristics (Continued)****AZ1117B-2.5 Electrical Characteristics**

Operating Conditions: $V_{IN}=4.5V$, $I_{OUT}=10mA$, $T_J=25^{\circ}C$, unless otherwise specified. ($P \leq$ maximum power dissipation). Limits appearing in **Boldface** type apply over the entire junction temperature range for operation, $-20^{\circ}C$ to $105^{\circ}C$.

Parameter	Symbol	Conditions	Min	Typ	Max	Unit
Output Voltage	V_{OUT}		2.475	2.5	2.525	V
		$10mA \leq I_{OUT} \leq 800mA$, $4.5V \leq V_{IN} \leq 10V$	2.455	2.5	2.545	
Line Regulation	V_{RLINE}	$1.5V \leq V_{IN} - V_{OUT} \leq 10V$		0.5	6	mV
					10	
Load Regulation	V_{RLOAD}			2	15	mV
Dropout Voltage	V_{DROP}	$\Delta V_{OUT}=1\%$, $I_{OUT}=0.8A$		1.2	1.3	V
Current Limit	I_{LIMIT}		0.85	1	1.15	A
Quiescent Current	I_Q	$I_{OUT}=0$		4	6	mA
Ripple Rejection	PSRR	$f=120Hz$, $C_{OUT}=22\mu F$ $(V_{IN}-V_{OUT})=3V$, $I_{OUT}=300mA$		70		dB
Temperature Stability				0.5		%
RMS Output Noise (% of V_{OUT})		$T_A=25^{\circ}C$, $10Hz \leq f \leq 10KHz$		0.003		%
Thermal Shutdown		Junction Temperature		160		$^{\circ}C$
Thermal Shutdown Hysteresis				16		$^{\circ}C$



800mA LOW DROPOUT LINEAR REGULATOR

AZ1117B

Electrical Characteristics (Continued)

AZ1117B-3.3 Electrical Characteristics

Operating Conditions: $V_{IN}=5.3V$, $I_{OUT}=10mA$, $T_J=25^{\circ}C$, unless otherwise specified. ($P \leq$ maximum power dissipation). Limits appearing in **Boldface** type apply over the entire junction temperature range for operation, $-20^{\circ}C$ to $105^{\circ}C$.

Parameter	Symbol	Conditions	Min	Typ	Max	Unit
Output Voltage	V_{OUT}		3.267	3.3	3.333	V
		$10mA \leq I_{OUT} \leq 800mA$, $5.3V \leq V_{IN} \leq 10V$	3.235	3.3	3.365	
Line Regulation	V_{RLINE}	$1.5V \leq V_{IN} - V_{OUT} \leq 10V$		0.5	6	mV
					10	
Load Regulation	V_{RLOAD}			2	15	mV
Dropout Voltage	V_{DROP}	$\Delta V_{OUT}=1\%$, $I_{OUT}=0.8A$		1.2	1.3	V
Current Limit	I_{LIMIT}		0.85	1	1.15	A
Quiescent Current	I_Q	$I_{OUT}=0$		4	6	mA
Ripple Rejection	PSRR	$f=120Hz$, $C_{OUT}=22\mu F$ $(V_{IN}-V_{OUT})=3V$, $I_{OUT}=300mA$		70		dB
Temperature Stability				0.5		%
RMS Output Noise (% of V_{OUT})		$T_A=25^{\circ}C$, $10Hz \leq f \leq 10KHz$		0.003		%
Thermal Shutdown		Junction Temperature		160		$^{\circ}C$
Thermal Shutdown Hysteresis				16		$^{\circ}C$



800mA LOW DROPOUT LINEAR REGULATOR

AZ1117B

Typical Performance Characteristics

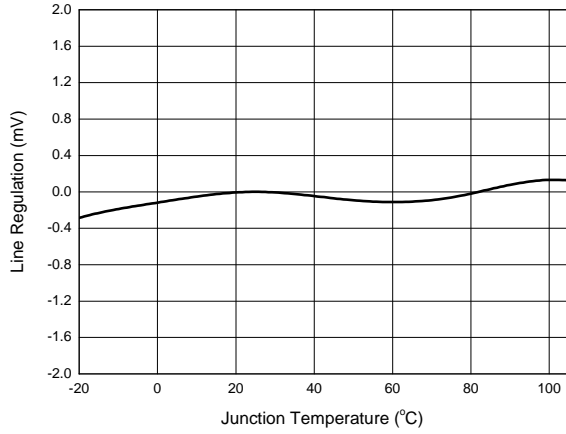

Figure 4. Line Regulation vs. Junction Temperature

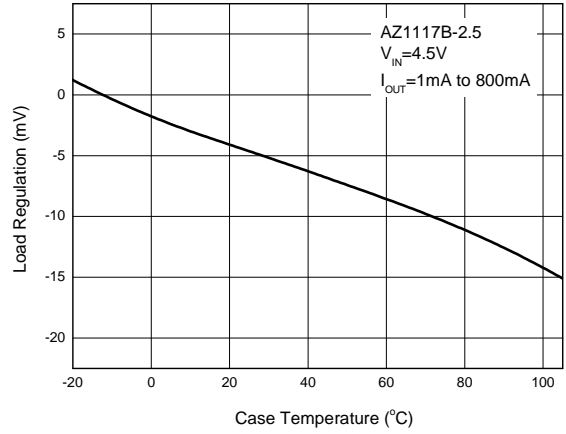

Figure 5. Load Regulation vs. Case Temperature

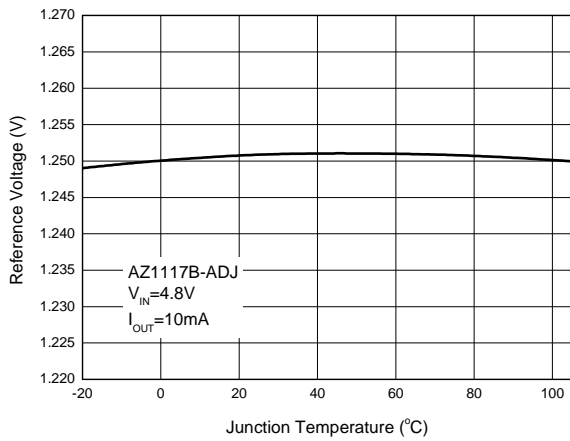

Figure 6. Reference Voltage vs. Junction Temperature

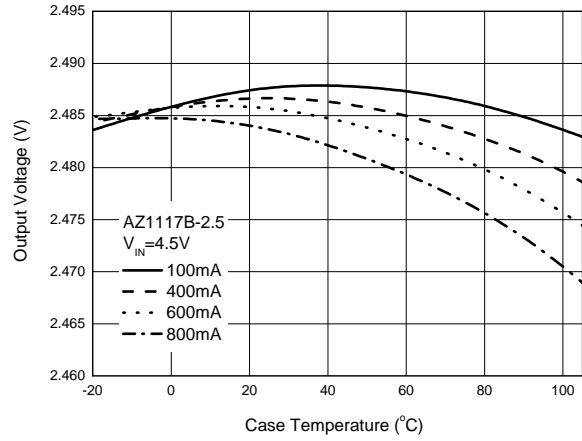

Figure 7. Output Voltage vs. Case Temperature



800mA LOW DROPOUT LINEAR REGULATOR

AZ1117B

Typical Performance Characteristics (Continued)

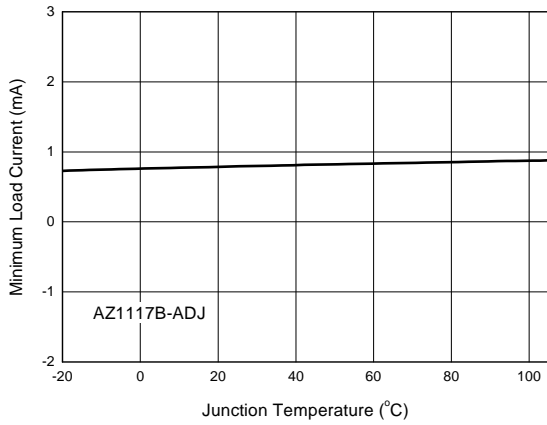

Figure 8. Minimum Load Current vs. Junction Temperature

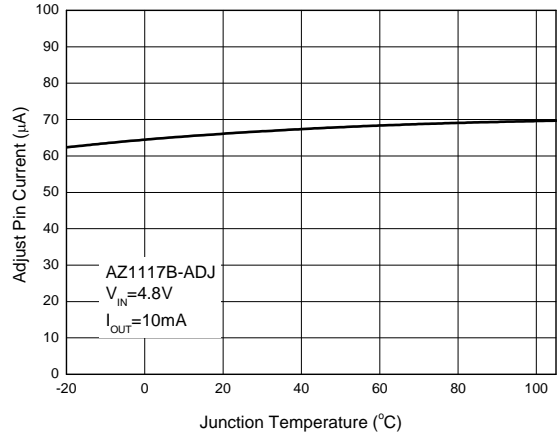

Figure 9. Adjust Pin Current vs. Junction Temperature

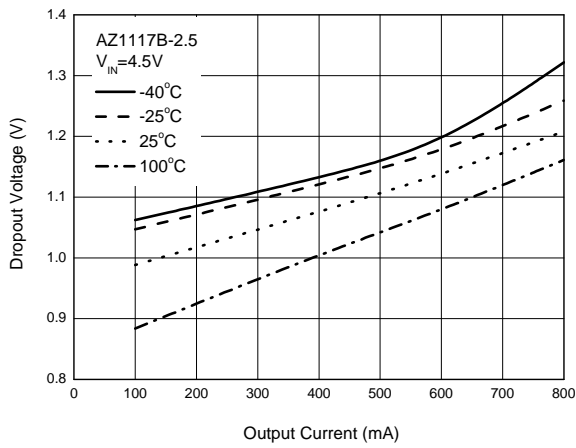

Figure 10. Dropout Voltage vs. Output Current

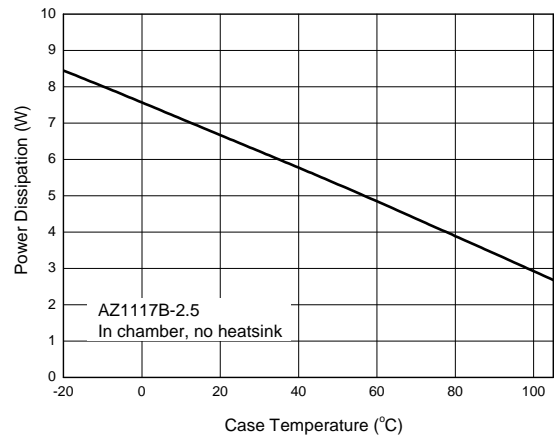

Figure 11. Power Dissipation vs. Case Temperature



800mA LOW DROPOUT LINEAR REGULATOR

AZ1117B

Typical Performance Characteristics (Continued)

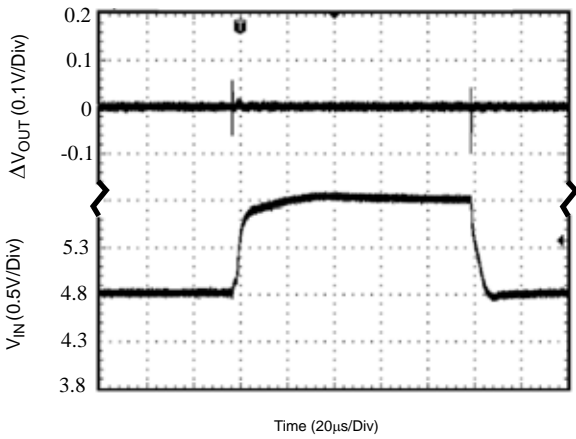

Figure 12. Line Transient Response

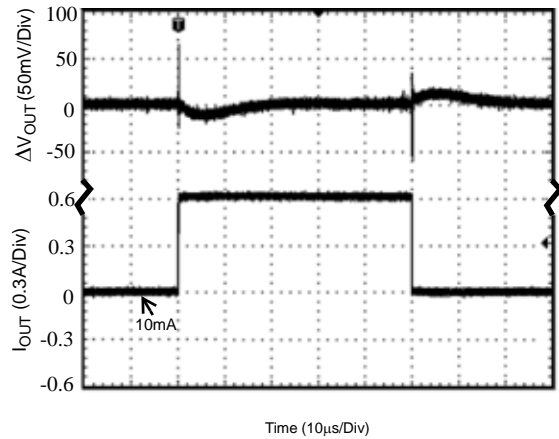

Figure 13. Load Transient Response

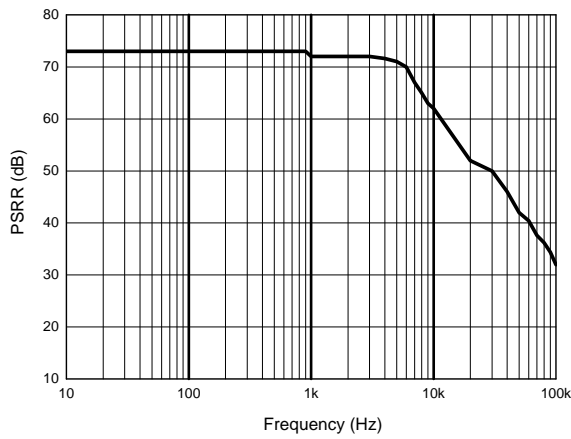

Figure 14. PSRR vs. Frequency

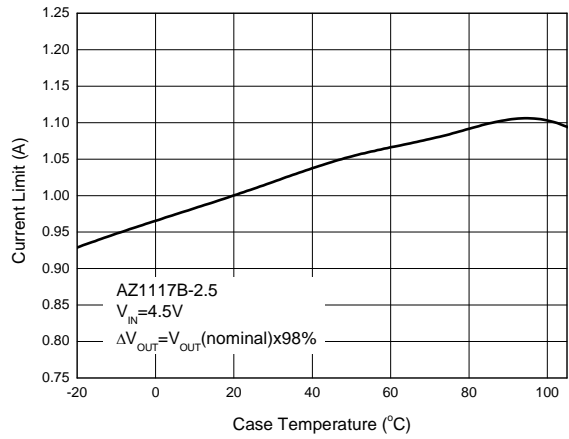

Figure 15. Current Limit vs. Case Temperature



800mA LOW DROPOUT LINEAR REGULATOR

AZ1117B

Typical Performance Characteristics (Continued)

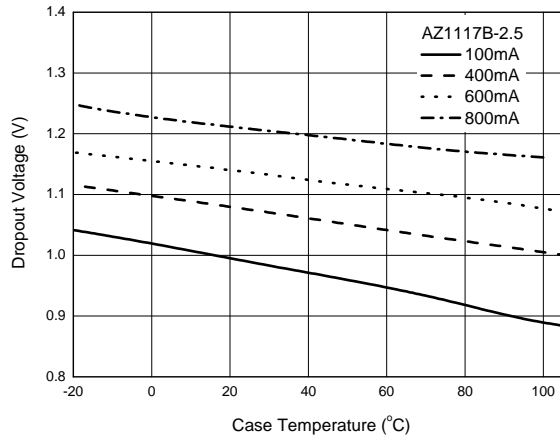

Figure 16. Dropout Voltage vs. Case Temperature

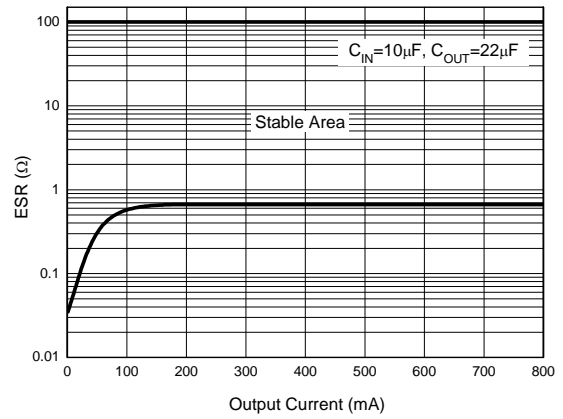

Figure 17. ESR vs. Output Current



800mA LOW DROPOUT LINEAR REGULATOR

AZ1117B

Typical Applications

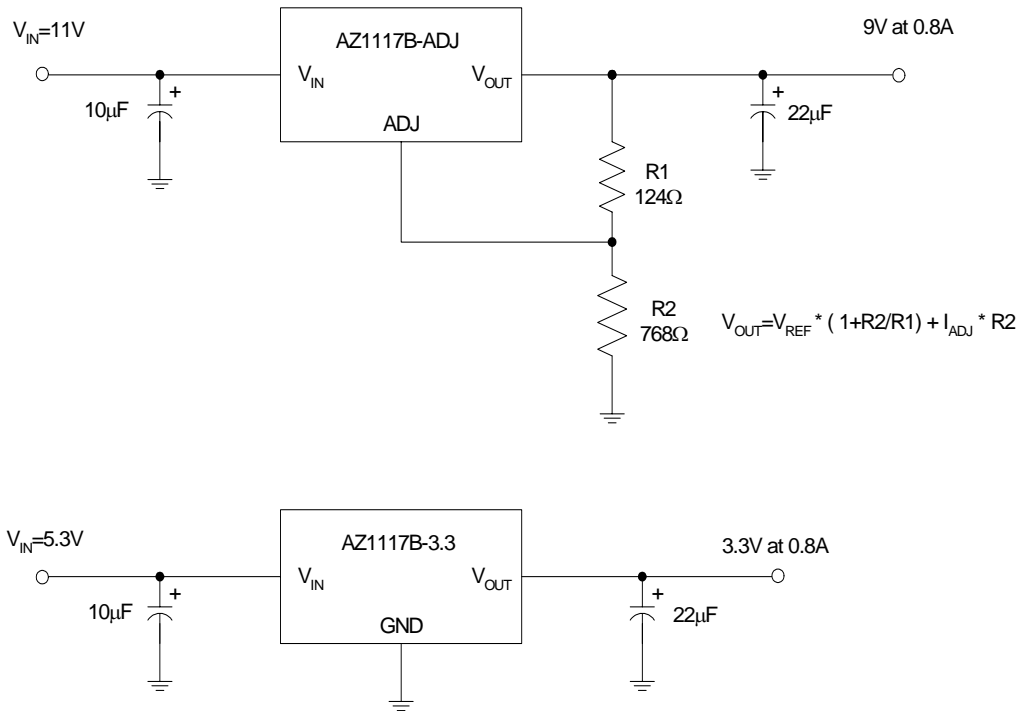

Figure 18. Typical Applications of AZ1117B



800mA LOW DROPOUT LINEAR REGULATOR

AZ1117B

Mechanical Dimensions

SOT-223

Unit: mm(inch)

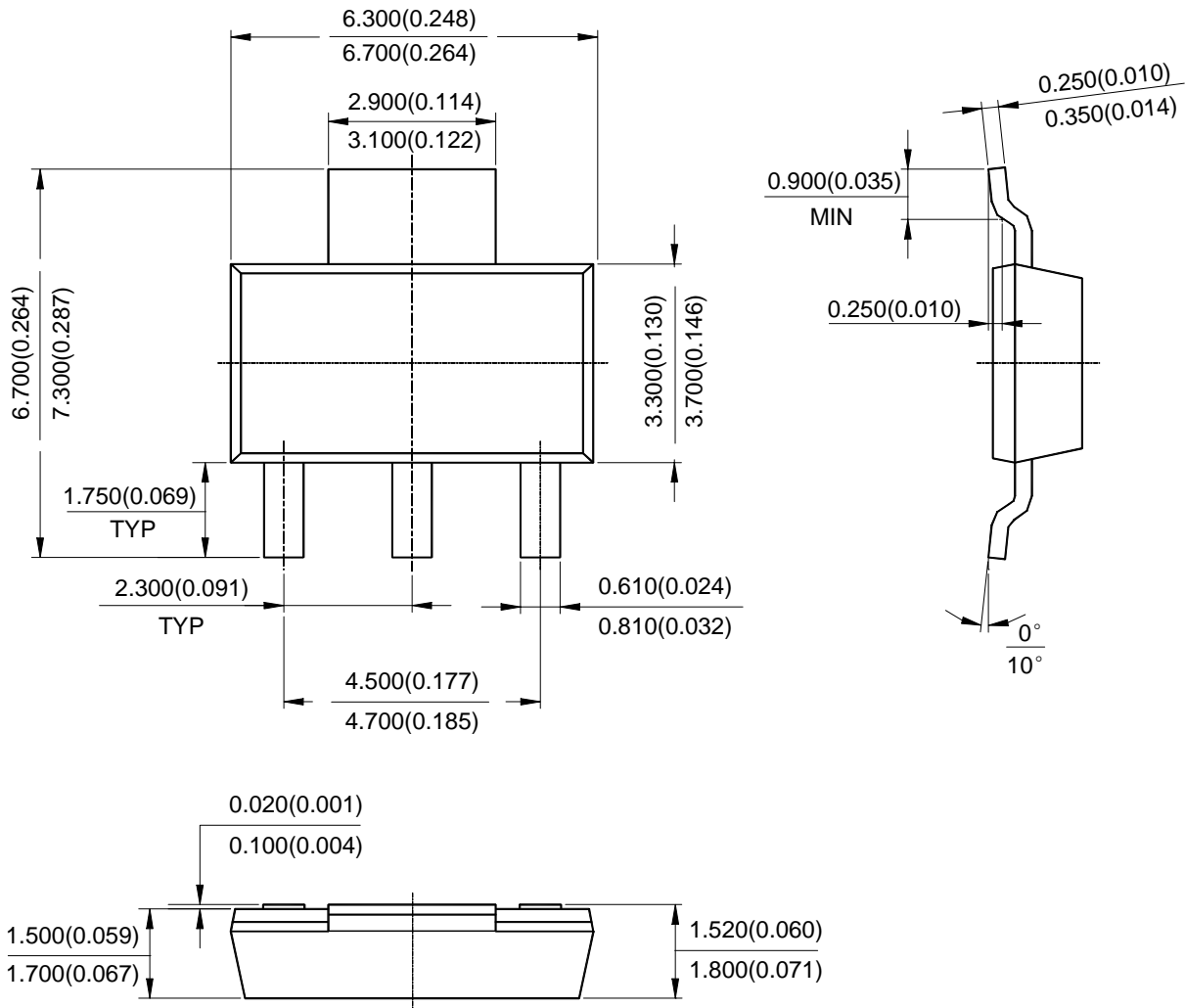



BCD Semiconductor Manufacturing Limited

<http://www.bcdsemi.com>

IMPORTANT NOTICE

BCD Semiconductor Manufacturing Limited reserves the right to make changes without further notice to any products or specifications herein. BCD Semiconductor Manufacturing Limited does not assume any responsibility for use of any its products for any particular purpose, nor does BCD Semiconductor Manufacturing Limited assume any liability arising out of the application or use of any its products or circuits. BCD Semiconductor Manufacturing Limited does not convey any license under its patent rights or other rights nor the rights of others.

MAIN SITE

BCD Semiconductor Manufacturing Limited
- Wafer Fab
Shanghai SIM-BCD Semiconductor Manufacturing Limited
800, Yi Shan Road, Shanghai 200233, China
Tel: +86-21-6485 1491, Fax: +86-21-5450 0008

BCD Semiconductor Manufacturing Limited
- IC Design Group
Advanced Analog Circuits (Shanghai) Corporation
8F, Zone B, 900, Yi Shan Road, Shanghai 200233, China
Tel: +86-21-6495 9539, Fax: +86-21-6485 9673

REGIONAL SALES OFFICE

Shenzhen Office
Shanghai SIM-BCD Semiconductor Manufacturing Co., Ltd. Shenzhen Office
Advanced Analog Circuits (Shanghai) Corporation Shenzhen Office
Room E, 5F, Noble Center, No.1006, 3rd Fuzhong Road, Futian District, Shenzhen 518026, China
Tel: +86-755-8826 7951
Fax: +86-755-8826 7865

Taiwan Office
BCD Semiconductor (Taiwan) Company Limited
4F, 298-1, Rui Guang Road, Nei-Hu District, Taipei,
Taiwan
Tel: +886-2-2656 2808
Fax: +886-2-2656 2806

USA Office
BCD Semiconductor Corporation
30920 Huntwood Ave. Hayward,
CA 94544, U.S.A
Tel : +1-510-324-2988
Fax: +1-510-324-2788