

# EQ-30 SERIES

Related Information

- General terms and conditions..... F-3
- Selection guide ..... P.231~
- Glossary of terms..... P.1549~
- General precautions ..... P.1552~



[panasonic.net/id/pidsx/global](http://panasonic.net/id/pidsx/global)

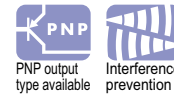

## Unaffected by color or material, 2 m (6.562 ft) distance adjustable range reflective sensing

### Hardly affected by object color or background Long sensing range 2 m 6.562 ft

As the EQ-30 series is incorporated with a 2-segment photodiode as the receiving element with a unique circuitry, it detects an object at the same distance regardless of its color or the background beyond the adjusted sensing range.

(However, when the background is specular, it may be necessary to change the angle of the sensor.)

The EQ-30 series can detect an object 2 m 6.562 ft away.

It is suitable for various applications, such as, sensing objects or positioning objects traveling on a wide assembly line, etc.

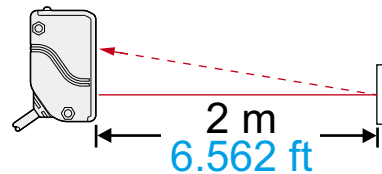

**EQ-34:** Correlation between material (200 × 200 mm 7.874 × 7.874 in) and sensing range (typical)

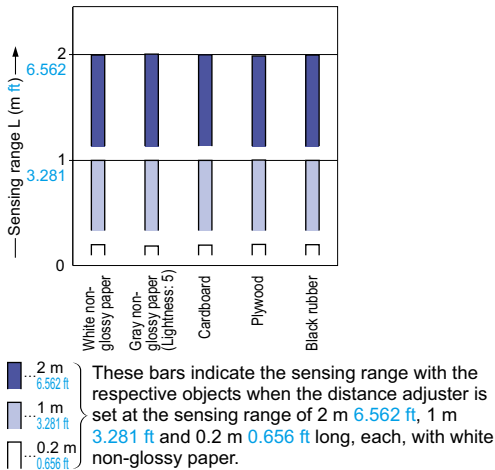

- Selection Guide
- Amplifier Built-in
- Power Supply Built-in
- Amplifier-separated
- EX-Z
- CX-400
- CY-100
- EX-10
- EX-20
- EX-30
- EX-40
- CX-440
- EQ-30**
- EQ-500
- MQ-W
- RX-LS200
- RX
- RT-610

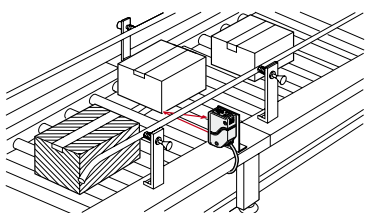
**APPLICATIONS****Detecting a passage of cardboard box****ENVIRONMENTAL RESISTANCE****Insusceptible to contamination on lens**

The fixed-focus sensing keeps the detectability better than diffuse reflective type sensors even if the lens is contaminated by dirt, dust, mist, or smoke under an unclean environment.

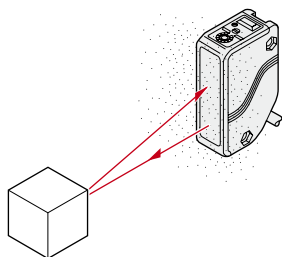
**Waterproof**

The sensors features an IP67 rating to allow their use in process lines where water is used or splashed.

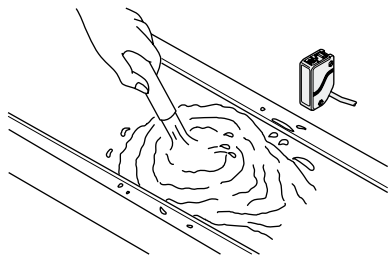

Note: If water splashes on the sensor during sensing operation, it may sense water as an object.

**Principle of adjustable range reflective sensing with 2-segment photodiode**

Normal reflective type sensors operate by sensing the variation in the amount of incident beam. However, the adjustable range reflective sensing type sensor incorporating the 2-segment photodiode operates by sensing the variation in the incident beam angle. Thus, the output is activated according to the distance of the object from the sensor. This system helps the **EQ-30** series in being unaffected by object color or a background, enabling stable sensing.

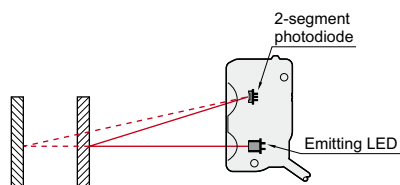

Sensing is based on the difference in the incident beam angle of the dotted line and the solid line in the above figure.

**OPERABILITY****Mechanical 2-turn adjuster with indicator**

It features a mechanical 2-turn distance adjuster with an indicator that shows the set distance at a glance.

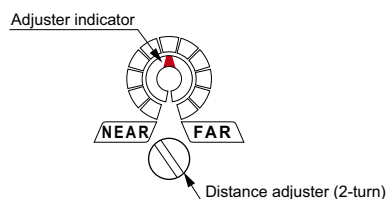
**MOUNTING / SIZE****Compact**

It saves space, since a miniaturized housing of  $W20 \times H68 \times D40$  mm  $W0.787 \times H2.677 \times D1.575$  in has been designed for the adjustable range reflective sensing sensor even though the adjustable sensing range is 2 m  $6.562$  ft long.

**VARIETIES****Plug-in connector type is available**

Plug-in connector type, which can be easily disconnected for replacement is available. In case a problem occurs, anyone can replace the sensor in a minute.

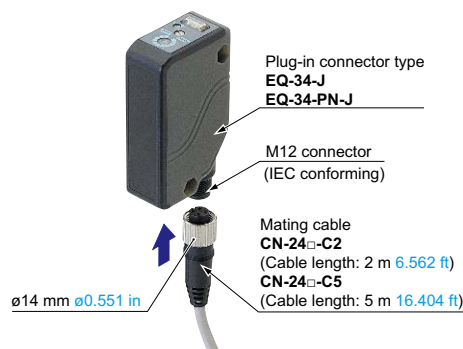

FIBER SENSORS

LASER SENSORS

PHOTOELECTRIC SENSORS

MICRO PHOTOELECTRIC SENSORS

AREA SENSORS

SAFETY LIGHT CURTAINS / SAFETY COMPONENTS

PRESSURE / FLOW SENSORS

INDUCTIVE PROXIMITY SENSORS

PARTICULAR USE SENSORS

SENSOR OPTIONS

SIMPLE WIRE-SAVING UNITS

WIRE-SAVING SYSTEMS

MEASUREMENT SENSORS

STATIC CONTROL DEVICES

LASER MARKERS

PLC

HUMAN MACHINE INTERFACES

ENERGY MANAGEMENT SOLUTIONS

FA COMPONENTS

MACHINE VISION SYSTEMS

UV CURING SYSTEMS

Selection Guide

Amplifier Built-in

Power Supply Built-in

Amplifier-separated

**EX-Z****CX-400****CY-100****EX-10****EX-20****EX-30****EX-40****CX-440****EQ-30****EQ-500****MQ-W****RX-LS200****RX****RT-610**

FIBER SENSORS  
LASER SENSORS  
PHOTO-ELECTRIC SENSORS  
MICRO PHOTO-ELECTRIC SENSORS  
AREA SENSORS  
SAFETY LIGHT CURTAINS / SAFETY COMPONENTS  
PRESSURE / FLOW SENSORS  
INDUCTIVE PROXIMITY SENSORS  
PARTICULAR USE SENSORS  
SENSOR OPTIONS  
SIMPLE WIRE-SAVING UNITS  
WIRE-SAVING SYSTEMS  
MEASUREMENT SENSORS  
STATIC CONTROL DEVICES  
LASER MARKERS  
PLC  
HUMAN MACHINE INTERFACES  
ENERGY MANAGEMENT SOLUTIONS  
FA COMPONENTS  
MACHINE VISION SYSTEMS  
UV CURING SYSTEMS  
Selection Guide  
Amplifier Built-in  
Power Supply Built-in  
Amplifier-separated

## ORDER GUIDE

Type	Appearance	Adjustable range (Note)	Model No.	Output
NPN output		0.2 to 2 m 0.656 to 6.562 ft	<b>EQ-34</b>	NPN open-collector transistor
PNP output			<b>EQ-34-PN</b>	PNP open-collector transistor

**NOTE:** Mounting bracket is not supplied with the sensor. Please select from the range of optional sensor mounting brackets (two types).

Note: The adjustable range stands for the maximum sensing range which can be set with the adjuster.  
The sensor can detect an object 0.1 m 0.328 ft, or more, away.

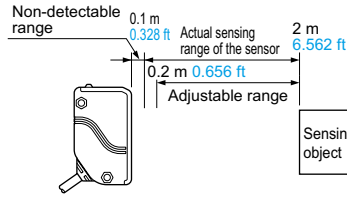

### Plug-in connector type

Plug-in connector type (standard: cable type) is also available.  
When ordering this type, suffix "-J" to the model No.  
Please order the suitable mating cable separately.  
Model No.: **EQ-34-J, EQ-34-PN-J**

#### • Mating cable

Type	Model No.	Length	Description
Straight	<b>CN-24-C2</b>	Length: 2 m 6.562 ft	0.34 mm <sup>2</sup> 4-core cabtyre cable with connector on one end Cable outer diameter: $\varnothing$ 5 mm $\varnothing$ 0.197 in
	<b>CN-24-C5</b>	Length: 5 m 16.404 ft	
Elbow	<b>CN-24L-C2</b>	Length: 2 m 6.562 ft	
	<b>CN-24L-C5</b>	Length: 5 m 16.404 ft	

#### • CN-24-C□

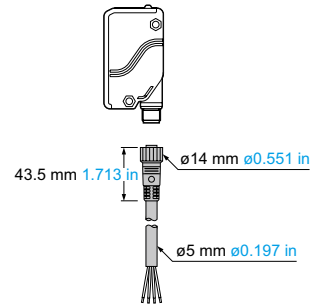

#### • CN-24L-C□

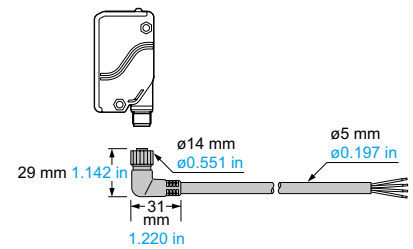

### 5 m 16.404 ft cable length type

5 m 16.404 ft cable length type (standard : 2 m 6.562 ft) is also available for NPN output type and two outputs type.  
When ordering this type, suffix "-C5" to the model No.  
Model No.: **EQ-34-C5**

## OPTIONS

Designation	Model No.	Description
Sensor mounting bracket	<b>MS-EQ3-1</b>	Back angled mounting bracket
	<b>MS-EQ3-2</b>	Foot angled mounting bracket

Note: The plug-in connector type does not allow use of some sensor mounting brackets because of the protrusion of the connector.

### Sensor mounting bracket

#### • MS-EQ3-1

Two M4 (length 25 mm 0.984 in) screws with washers and two M4 nuts are attached.

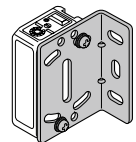

#### • MS-EQ3-2

Two M4 (length 25 mm 0.984 in) screws with washers and two M4 nuts are attached.

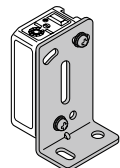

EX-Z  
CX-400  
CY-100  
EX-10  
EX-20  
EX-30  
EX-40  
CX-440  
EQ-30  
EQ-500  
MQ-W  
RX-LS200  
RX  
RT-610

**SPECIFICATIONS**

Type	NPN output	PNP output
Item	Model No.	Model No.
	EQ-34	EQ-34-PN
CE marking directive compliance	EMC Directive, RoHS Directive	
Adjustable range (Note 2)	0.2 to 2 m <b>0.656 to 6.562 ft</b>	
Sensing range (with white non-glossy paper at setting distance 2 m <b>6.562 ft</b> )	0.1 to 2 m <b>0.328 to 6.562 ft</b>	
Hysteresis	10 % or less of operation distance (With white non-glossy paper)	
Repeatability	Along sensing axis: 10 mm <b>0.394 in</b> or less, Perpendicular to sensing axis: 1 mm <b>0.039 in</b> or less (with white non-glossy paper)	
Supply voltage	10 to 30 V DC Ripple P-P 10 % or less	
Current consumption	50 mA or less	55 mA or less
Output	NPN open-collector transistor <ul style="list-style-type: none"> <li>• Maximum sink current: 100 mA</li> <li>• Applied voltage: 30 V DC or less (between output and 0 V)</li> <li>• Residual voltage: 1 V or less (at 100 mA sink current) 0.4 V or less (at 16 mA sink current)</li> </ul>	PNP open-collector transistor <ul style="list-style-type: none"> <li>• Maximum source current: 100 mA</li> <li>• Applied voltage: 30 V DC or less (between output and +V)</li> <li>• Residual voltage: 1 V or less (at 100 mA source current) 0.4 V or less (at 16 mA source current)</li> </ul>
Utilization category	DC-12 or DC-13	
Output operation	Switchable either Detection-ON or Detection-OFF	
Short-circuit protection	Incorporated	
Response time	2 ms or less	
Operation indicator	Red LED (lights up when the output is ON)	
Stability indicator	Green LED (lights up under stable light received condition or stable dark condition) (Note 3)	
Distance adjuster	2-turn mechanical adjuster with pointer	
Automatic interference prevention function	Incorporated (Note 4)	
Environmental resistance	Pollution degree	3 (Industrial environment)
	Protection	IP67 (IEC)
	Ambient temperature	-20 to +55 °C <b>-4 to +131 °F</b> (No dew condensation or icing allowed), Storage: -25 to +70 °C <b>-13 to +158 °F</b>
	Ambient humidity	35 to 85 % RH, Storage: 35 to 85 % RH
	Ambient illuminance	Incandescent light: 3,000 lx or less at the light-receiving face
	Voltage withstandability	1,000 V AC for one min. between all supply terminals connected together and enclosure
	Insulation resistance	20 MΩ, or more, with 250 V megger between all supply terminals connected together and enclosure
	Vibration resistance	10 to 55 Hz frequency, 1.5 mm <b>0.059 in</b> double amplitude (10 G max.) in X, Y and Z directions for two hours each
Shock resistance	500 m/s <sup>2</sup> acceleration (50 G approx.) in X, Y and Z directions three times each	
Emitting element	Infrared LED (Peak emission wavelength: 880 nm <b>0.035 mil</b> , modulated)	
Material	Enclosure: Polyallylate and Polyethylene terephthalate, Lens: Polyallylate	
Cable	0.3 mm <sup>2</sup> 3-core cabtyre cable, 2 m <b>6.562 ft</b> long	
Cable extension	Extension up to total 100 m <b>328.084 ft</b> is possible with 0.3 mm <sup>2</sup> , or more, cable.	
Weight	Net weight: 150 g approx., Gross weight: 200 g approx.	
Accessory	Adjusting screwdriver: 1 pc.	

Notes: 1) Where measurement conditions have not been specified precisely, the conditions used were an ambient temperature of +23 °C **+73.4 °F**.

- 2) The adjustable range stands for the maximum sensing range which can be set with the adjuster.  
The sensor can detect an object 0.1 m **0.328 ft**, or more, away.

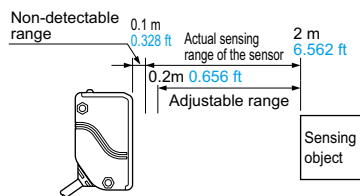

- 3) Refer to "**Stability indicator** (p.327)" of "**PRECAUTIONS FOR PROPER USE**" for details of the stability indicator.  
4) Detection may become unstable depending on the setting conditions or the sensing objects. After setting up this product, make sure to check operations using actual sensing objects.

FIBER  
SENSORSLASER  
SENSORSPHOTO-  
ELECTRIC  
SENSORSMICRO  
PHOTO-  
ELECTRIC  
SENSORSAREA  
SENSORSSAFETY LIGHT  
CURTAINS /  
SAFETY  
COMPONENTSPRESSURE /  
FLOW  
SENSORSINDUCTIVE  
PROXIMITY  
SENSORSPARTICULAR  
USE  
SENSORSSENSOR  
OPTIONSSIMPLE  
WIRE-SAVING  
UNITSWIRE-SAVING  
SYSTEMSMEASURE-  
MENT  
SENSORSSTATIC  
CONTROL  
DEVICESLASER  
MARKERS

PLC

HUMAN  
MACHINE  
INTERFACESENERGY  
MANAGEMENT  
SOLUTIONSFA  
COMPONENTSMACHINE  
VISION  
SYSTEMSUV  
CURING  
SYSTEMSSelection  
GuideAmplifier  
Built-inPower Supply  
Built-inAmplifier-  
separated**EX-Z****CX-400****CY-100****EX-10****EX-20****EX-30****EX-40****CX-440****EQ-30****EQ-500****MQ-W****RX-LS200****RX****RT-610**

FIBER SENSORS

LASER SENSORS

PHOTO-ELECTRIC SENSORS

MICRO PHOTO-ELECTRIC SENSORS

AREA SENSORS

SAFETY LIGHT CURTAINS / SAFETY COMPONENTS

PRESSURE / FLOW SENSORS

INDUCTIVE PROXIMITY SENSORS

PARTICULAR USE SENSORS

SENSOR OPTIONS

SIMPLE WIRE-SAVING UNITS

WIRE-SAVING SYSTEMS

MEASUREMENT SENSORS

STATIC CONTROL DEVICES

LASER MARKERS

PLC

HUMAN MACHINE INTERFACES

ENERGY MANAGEMENT SOLUTIONS

FA COMPONENTS

MACHINE VISION SYSTEMS

UV CURING SYSTEMS

Selection Guide

Amplifier Built-in

Power Supply Built-in

Amplifier-separated

**I/O CIRCUIT AND WIRING DIAGRAMS**

**EQ-34** NPN output type

**I/O circuit diagram**

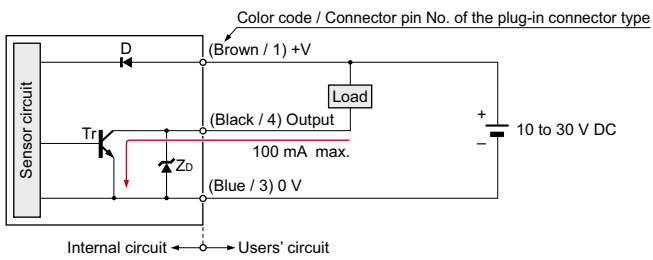

Symbols ... D : Reverse supply polarity protection diode  
 Zd: Surge absorption zener diode  
 Tr : NPN output transistor

**Wiring diagram**

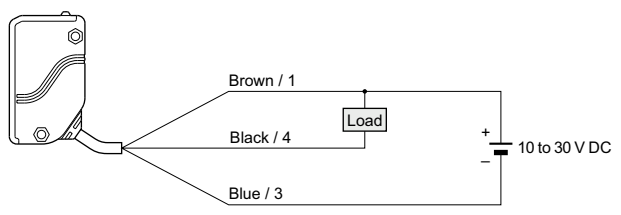

**Connector pin position (Plug-in connector type)**

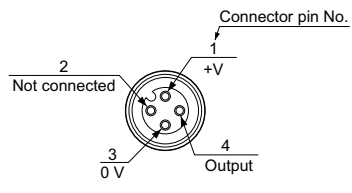

**EQ-34-PN** PNP output type

**I/O circuit diagram**

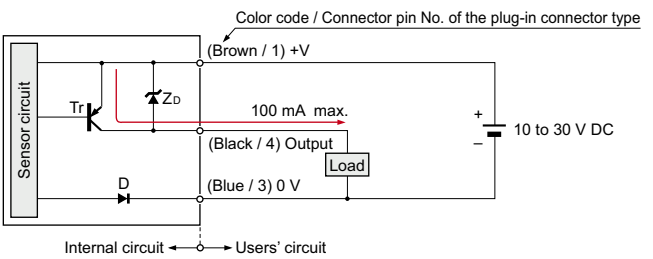

Symbols ... D : Reverse supply polarity protection diode  
 Zd: Surge absorption zener diode  
 Tr : PNP output transistor

**Wiring diagram**

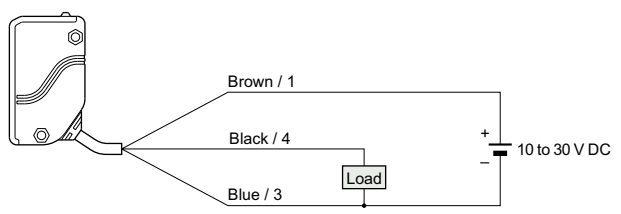

**Connector pin position (Plug-in connector type)**

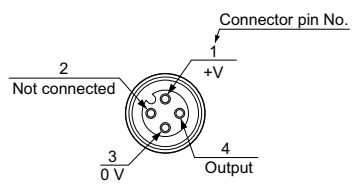

EX-Z

CX-400

CY-100

EX-10

EX-20

EX-30

EX-40

CX-440

**EQ-30**

EQ-500

MQ-W

RX-LS200

RX

RT-610

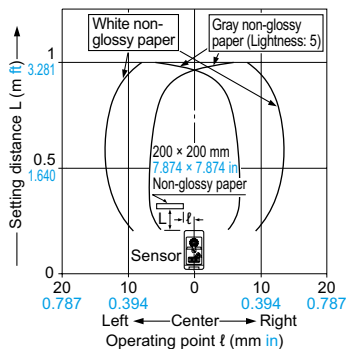
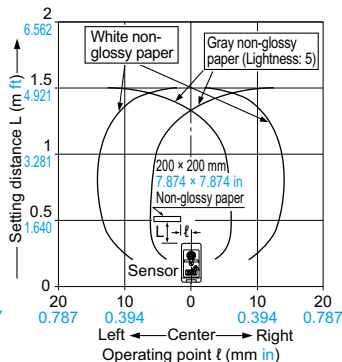
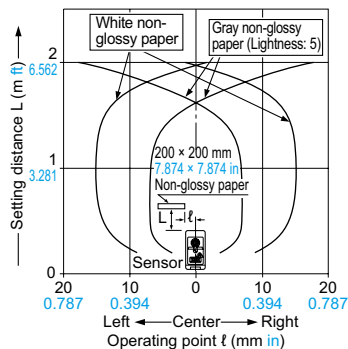
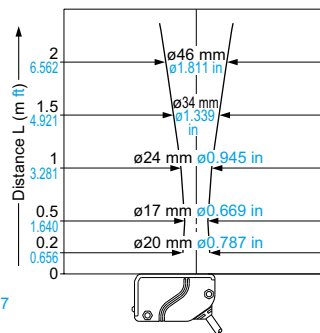
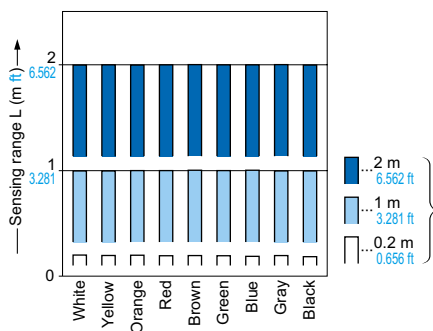
**SENSING CHARACTERISTICS (TYPICAL)****EQ-34 EQ-34-PN****Sensing fields**• Setting distance: 1 m **3.281 ft**• Setting distance: 1.5 m **4.921 ft**• Setting distance: 2 m **6.562 ft****Emitted beam****Correlation between color (200 x 200 mm 7.874 x 7.874 in non-glossy paper) and sensing range**

These bars indicate the sensing range with the respective colors when the distance adjuster is set at the sensing range of 2 m **6.562 ft**, 1 m **3.281 ft** and 0.2 m **0.656 ft** long, each, with white color. The sensing distance varies depending also on material.

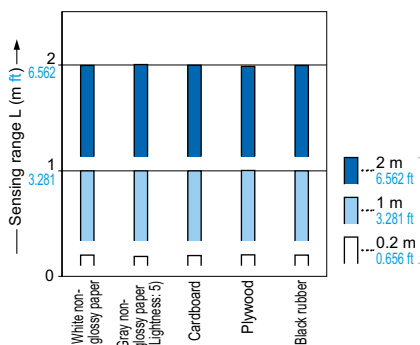
**Correlation between material (200 x 200 mm 7.874 x 7.874 in) and sensing range**

These bars indicate the sensing range with respective objects when the distance adjuster is set at the sensing range of 2 m **6.562 ft**, 1 m **3.281 ft** and 0.2 m **0.656 ft** long, each, with white non-glossy paper.

FIBER SENSORS

LASER SENSORS

PHOTO-ELECTRIC SENSORS

MICRO PHOTO-ELECTRIC SENSORS

AREA SENSORS

SAFETY LIGHT CURTAINS / SAFETY COMPONENTS

PRESSURE / FLOW SENSORS

INDUCTIVE PROXIMITY SENSORS

PARTICULAR USE SENSORS

SENSOR OPTIONS

SIMPLE WIRE-SAVING UNITS

WIRE-SAVING SYSTEMS

MEASUREMENT SENSORS

STATIC CONTROL DEVICES

LASER MARKERS

PLC

HUMAN MACHINE INTERFACES

ENERGY MANAGEMENT SOLUTIONS

FA COMPONENTS

MACHINE VISION SYSTEMS

UV CURING SYSTEMS

Selection Guide

Amplifier Built-in

Power Supply Built-in

Amplifier-separated

**EX-Z****CX-400****CY-100****EX-10****EX-20****EX-30****EX-40****CX-440****EQ-30****EQ-500****MQ-W****RX-LS200****RX****RT-610**



- FIBER SENSORS
- LASER SENSORS
- PHOTO-ELECTRIC SENSORS
- MICRO PHOTO-ELECTRIC SENSORS
- AREA SENSORS
- SAFETY LIGHT CURTAINS / SAFETY COMPONENTS
- PRESSURE / FLOW SENSORS
- INDUCTIVE PROXIMITY SENSORS
- PARTICULAR USE SENSORS
- SENSOR OPTIONS
- SIMPLE WIRE-SAVING UNITS
- WIRE-SAVING SYSTEMS
- MEASUREMENT SENSORS
- STATIC CONTROL DEVICES
- LASER MARKERS
- PLC
- HUMAN MACHINE INTERFACES
- ENERGY MANAGEMENT SOLUTIONS
- FA COMPONENTS
- MACHINE VISION SYSTEMS
- UV CURING SYSTEMS
- Selection Guide
- Amplifier Built-in
- Power Supply Built-in
- Amplifier-separated
- EX-Z**
- CX-400**
- CY-100**
- EX-10**
- EX-20**
- EX-30**
- EX-40**
- CX-440**
- EQ-30**
- EQ-500**
- MQ-W**
- RX-LS200**
- RX**
- RT-610**

## PRECAUTIONS FOR PROPER USE

Refer to p.1552~ for general precautions.



- Never use this product as a sensing device for personnel protection.
- In case of using sensing devices for personnel protection, use products which meet laws and standards, such as OSHA, ANSI or IEC etc., for personnel protection applicable in each region or country.

### Stability indicator

- Since the **EQ-30** series uses a 2-segment photodiode as its receiving element, and sensing is done based on the difference in the incident beam angle of the reflected beam from the sensing object, the output and the operation indicator operate according to the object distance. Further, the stability indicator shows the margin of the incident light intensity and not that of the object distance. Hence, the distance at which it lights up/off depends on the object reflectivity and is not at all related to the output operation. Do not use the sensor when the stability indicator is off (unstable light received condition), since the sensing will be unstable.

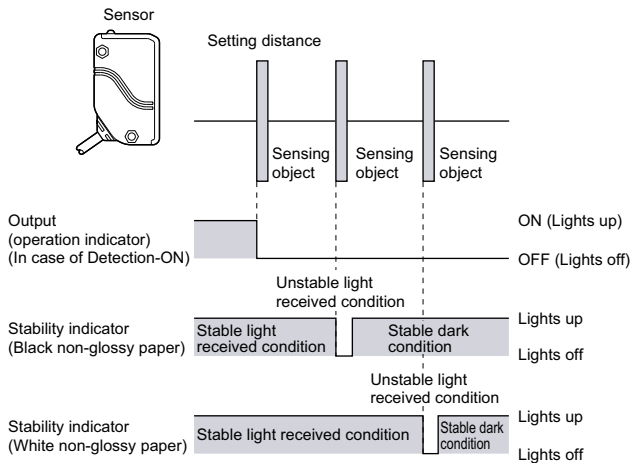

### Others

- Do not use during the initial transient time (50 ms) after the power supply is switched on.
- When connecting the mating cable to the plug-in connector type, the tightening torque should be 0.4 N·m or less.

### Mounting

- The tightening torque should be 0.8 N·m or less.

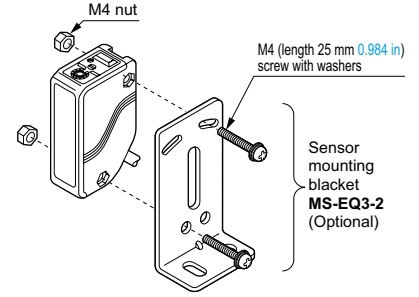

- Care must be taken regarding the sensor mounting direction with respect to the object's direction of movement.

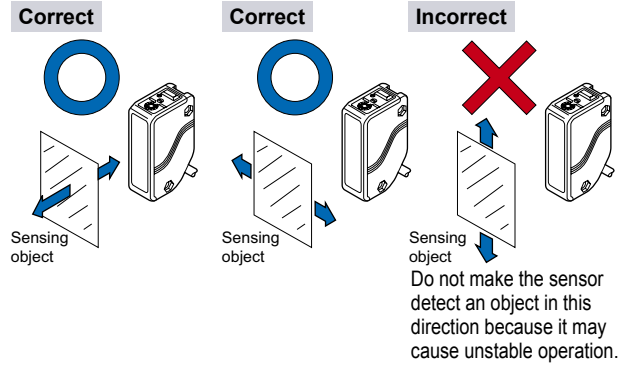

- When detecting a specular object (aluminum or copper foil) or an object having a glossy surface or coating, please take care that there are cases when the object may not be detected due to a small change in angle, wrinkles on the object surface, etc.
- When a specular body is present below the sensor, use the sensor by tilting it slightly upwards to avoid wrong operation.

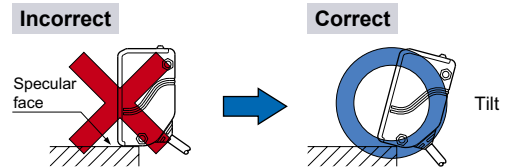

- If a specular body is present in the background, wrong operation may be caused due to a small change in the angle of the background body. In that case, install the sensor at an inclination and confirm the operation with the actual sensing object.
- Take care that some objects may produce a dead zone right (less than 0.1 m 0.328 ft) in front of the sensor.

