

3.5GHz High Power Amplifier for WiMAX applications

FEATURES:

- 3.5GHz WiMAX power amplifier
- 17dB gain
- 2.5% EVM with 30dBm transmit power
- 10% PAE with 30dBm transmit power
- 10W P_{sat}
- 20 lead air-cavity QFN with Cu lead frame

GENERAL DESCRIPTION:

FMA3016-QFN is a high power packaged MMIC amplifier for 3.5GHz WiMAX applications. This device exhibits 17dB of gain, has a P_{sat} of greater than 10W and 2.5% EVM with 10% PAE at 30dB transmit power with a 64 QAM OFDM signal. The part is packaged in a 20 lead air-cavity QFN (8x6x1.4mm) with a copper lead frame for enhanced thermal performance.

FMA3016-QFN EVALUATION BOARD:

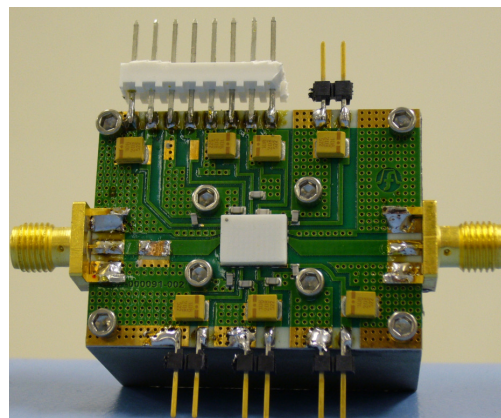

TYPICAL APPLICATIONS:

- WiMAX
- 802.16 Broadband wireless

ELECTRICAL SPECIFICATIONS:

PARAMETER	CONDITIONS	MIN	TYP	MAX	UNITS
Frequency Range		3.4		3.6	GHz
Gain			17		dB
Gain variation over temperature	-40 to +85 deg C Base Plate Temperature		± 1.5		dB
Input Return Loss			12		dB
Output Return Loss			10		dB
EVM @30dBm transmit power	OFDM signal			2.5	%
PAE @30dBm transmit power	OFDM signal	9	10		%
Output power at P_{1dB}	CW conditions		38		dBm
Output IP3	CW conditions		50		dBm
ACP @30dBm P_{out}	7MHz BW, Adjacent Channel Power measured in a 1MHz BW, offset by 7.5MHz from the centre frequency		-52		dBc
Noise Figure			10		dB
Stability	Unconditional across all frequencies with appropriate decoupling networks				
V_{D1}, V_{D2}		8		10	V
V_{G1}, V_{G2}	Class AB to obtain optimum linearity	-1.2		-0.5	V
I_{DS}			1.2		A

ABSOLUTE MAXIMUM RATINGS:

PARAMETER	SYMBOL	ABSOLUTE MAXIMUM
Max Input Power	P_{in}	+32dBm
Drain Bias Voltage		+15V
Storage Temp	T_{stor}	-55°C to +150°C

Note: Exceeding any one of these absolute maximum ratings may cause permanent damage to the device.

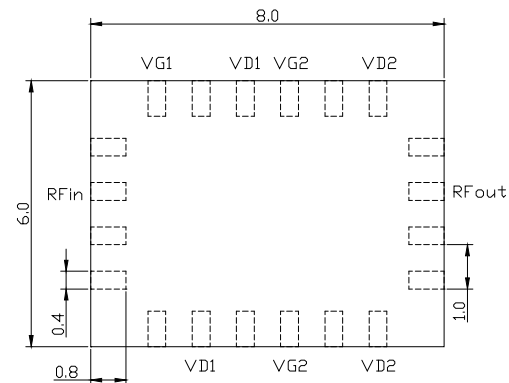
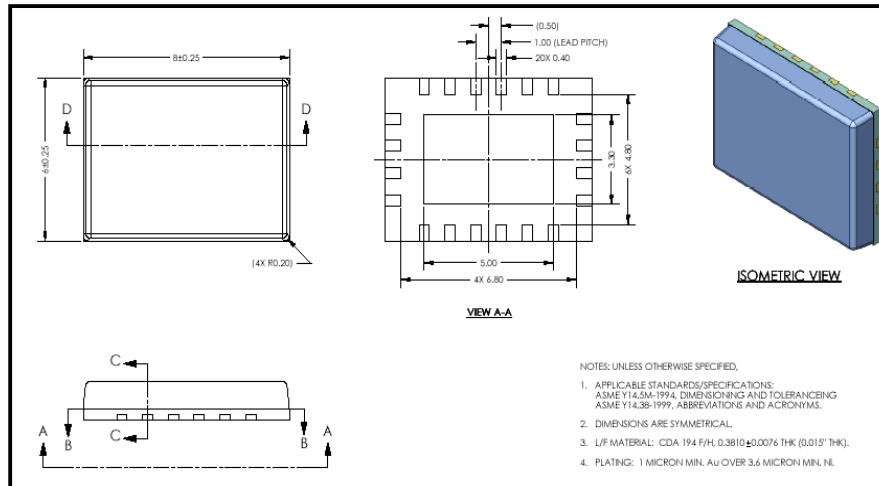
PACKAGE PIN OUT

PACKAGE LAYOUT:

THERMAL INFORMATION

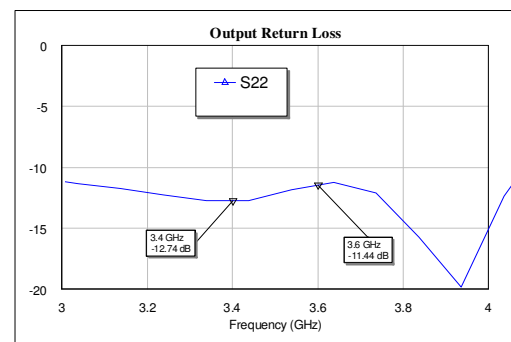
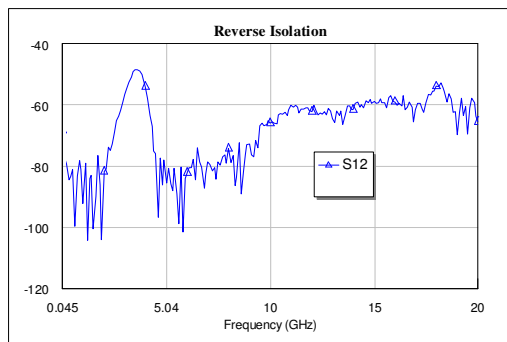
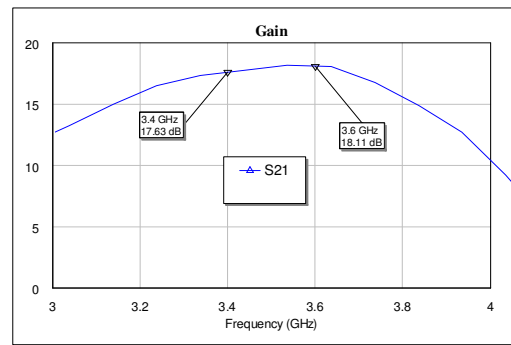
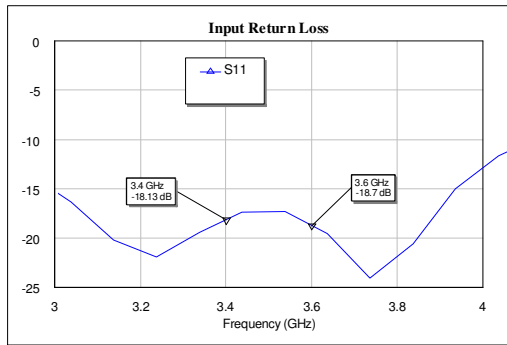
Parameter	Test Conditions	T_{ch} (°C)	$R_{\theta JC}$ (°C/W)
$R_{\theta JC}$ Thermal Resistance (Channel to backside of package)	$V_d = 8\text{ V}$ $I_D = 1.2\text{ A}$ $P_{diss} = 9.6\text{ W}$	140	6

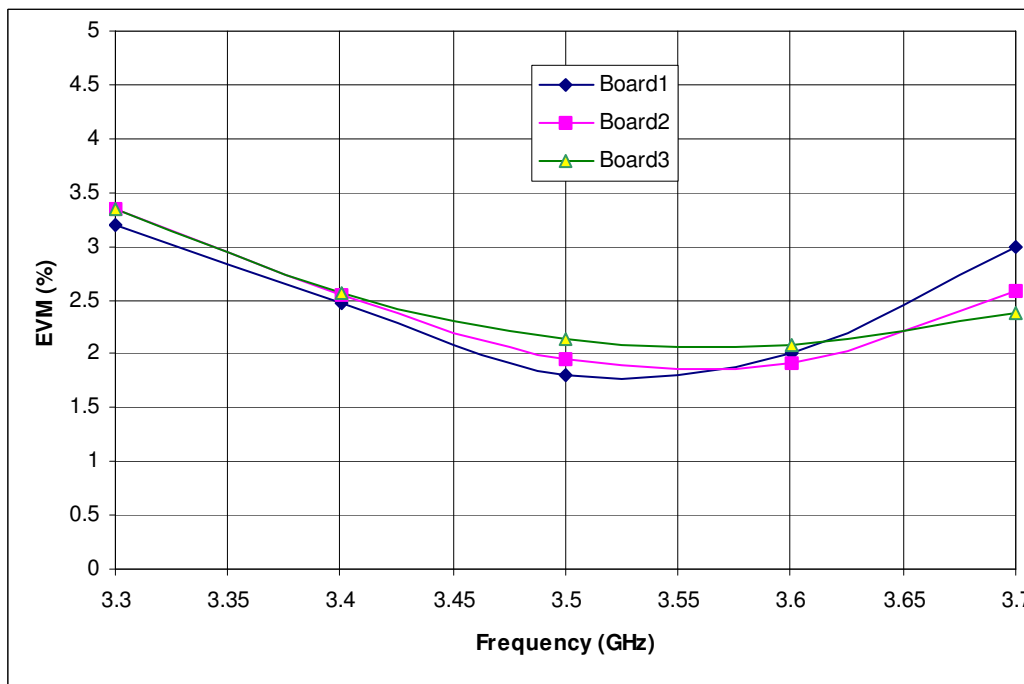
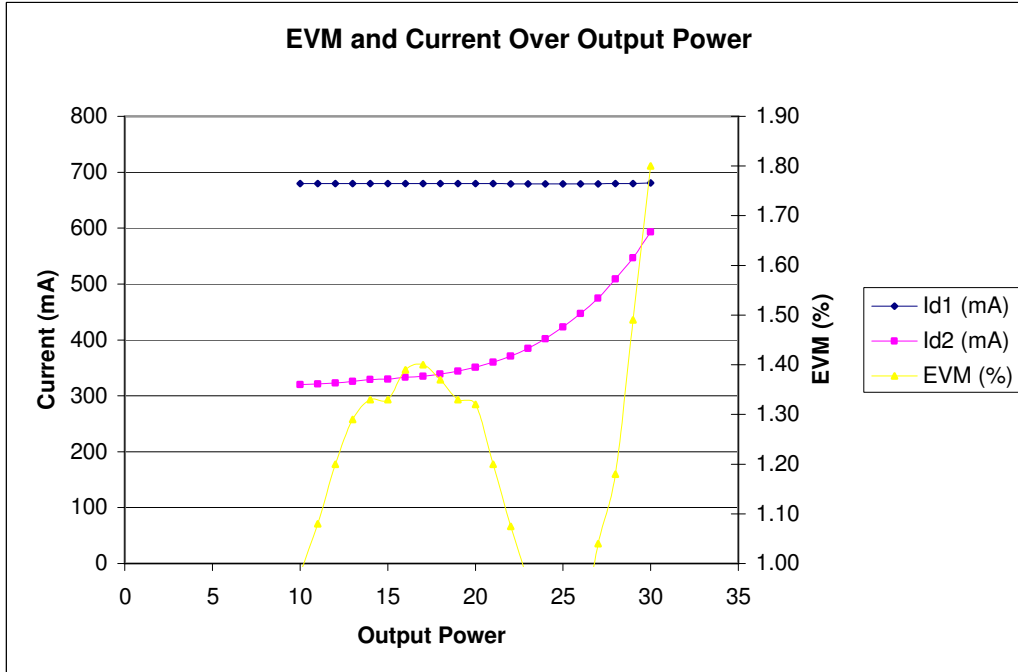
TYPICAL MEASURED PERFORMANCE ON-WAFER:

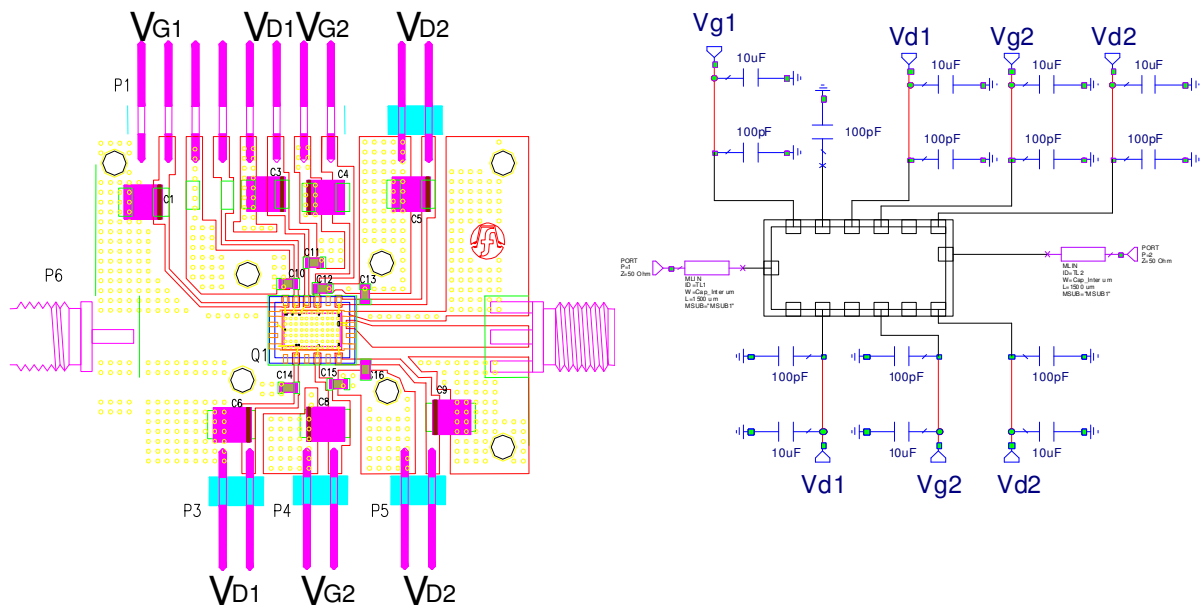
 Note: Measurement Conditions $V_{D1}, V_{D2} = 10V$ & $I_D = 700mA$, $T_{AMBIENT} = 25^\circ C$

TYPICAL MEASURED PERFORMANCE EVALUATION BOARD:
NOTE: MEASUREMENT CONDITIONS V_{D1} , $V_{D2}= 8V$, $T_{AMBIENT} = 25^{\circ}C$

EVALUATION BOARD COMPONENT LAYOUT:

BILL OF MATERIALS:

LABEL	COMPONENT
Board	Preferred evaluation board material is 30-mil thick ROGERS RT4350. All RF tracks should be 50-ohm characteristic material
P6, P7	SMA RF edge connector
P1, P2, P3, P4, P5	DC connector
C1, C2, C3, C4, C5, C6, C7, C8, C9,	Capacitor, 10uF, 0603
C10,C11, C12,C13, C14,C15, C16,C17, C18, C19	Capacitor, 100pF, 0603
Q1	FMA3016-QFN

PREFERRED ASSEMBLY INSTRUCTIONS:

Please contact Filtronic Compound Semiconductors for further details.

PART NUMBER	DESCRIPTION
FMA3016-QFN	Packaged MMIC

HANDLING PRECAUTIONS:

To avoid damage to the devices care should be exercised during handling. Proper Electrostatic Discharge (ESD) precautions should be observed at all stages of storage, handling, assembly, and testing. These devices should be treated as Class 1A (250-500 V) as defined in JEDEC Standard No. 22-A114. Further information on ESD control measures can be found in MIL-STD-1686 and MIL-HDBK-263.

DISCLAIMERS:

This product is not designed for use in any space based or life sustaining/supporting equipment.