



## PIN Connection TO-220F

$V_{DSS}$	650	V
$I_D$	10	A
$P_D(T_C=25^\circ\text{C})$	40	W
$R_{DS(ON)Typ}$	0.85	$\Omega$

## Features

- I Fast Switching
- I Low ON Resistance( $R_{dson} \leq 1.0\Omega$ )
- I Low Gate Charge (Typical Data:32nC)
- I Low Reverse transfer capacitances(Typical:7pF)
- I 100% Single Pulse avalanche energy Test

## Applications

Power switch circuit of adaptor and charger.

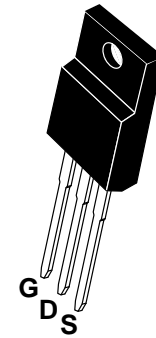

## Schematic diagram

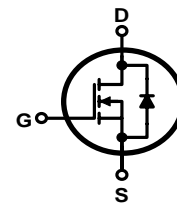

## Marking Diagram



Y = Year  
 A = Assembly Location  
 WW = Work Week  
 VT = Version & Thickness  
 FIR10N65F = Specific Device Code

## Absolute (Tc= 25°C unless otherwise specified):

Symbol	Parameter	Rating	Units
$V_{DSS}$	Drain-to-Source Voltage	650	V
$I_D$	Continuous Drain Current	10	A
	Continuous Drain Current $T_C = 100^\circ\text{C}$	6.3	A
$I_{DM}^{a1}$	Pulsed Drain Current	40	A
$V_{GS}$	Gate-to-Source Voltage	$\pm 30$	V
$E_{AS}^{a2}$	Single Pulse Avalanche Energy	540	mJ
$dv/dt^{a3}$	Peak Diode Recovery dv/dt	5.0	V/ns
$P_D$	Power Dissipation	40	W
	Derating Factor above 25°C	0.32	W/°C
$T_J, T_{stg}$	Operating Junction and Storage Temperature Range	150, -55 to 150	°C
$T_L$	Maximum Temperature for Soldering	300	°C



**Electrical Characteristics** (Tc= 25°C unless otherwise specified):

OFF Characteristics						
Symbol	Parameter	Test Conditions	Rating			Unit s
			Min.	Typ.	Max.	
V <sub>DSS</sub>	Drain to Source Breakdown Voltage	V <sub>GS</sub> =0V, I <sub>D</sub> =250μA	650	--	--	V
Δ BV <sub>DSS</sub> / Δ T <sub>J</sub>	Bvdss Temperature Coefficient	I <sub>D</sub> =250μA, Reference 25°C	--	0.7	--	V/°C
I <sub>DSS</sub>	Drain to Source Leakage Current	V <sub>DS</sub> =650V, V <sub>GS</sub> = 0V, T <sub>a</sub> = 25°C	--	--	1	μA
		V <sub>DS</sub> =520V, V <sub>GS</sub> = 0V, T <sub>a</sub> = 125°C	--	--	100	μA
I <sub>GSS(F)</sub>	Gate to Source Forward Leakage	V <sub>GS</sub> =+30V	--	--	100	nA
I <sub>GSS(R)</sub>	Gate to Source Reverse Leakage	V <sub>GS</sub> =-30V	--	--	-100	nA

ON Characteristics						
Symbol	Parameter	Test Conditions	Rating			Units
			Min.	Typ.	Max.	
R <sub>DS(ON)</sub>	Drain-to-Source On-Resistance	V <sub>GS</sub> =10V, I <sub>D</sub> =5A	--	0.85	1.0	Ω
V <sub>GS(TH)</sub>	Gate Threshold Voltage	V <sub>DS</sub> = V <sub>GS</sub> , I <sub>D</sub> = 250μA	2.0	--	4.0	V
Pulse width tp ≤ 300μs, δ ≤ 2%						

Dynamic Characteristics						
Symbol	Parameter	Test Conditions	Rating			Units
			Min.	Typ.	Max.	
g <sub>fs</sub>	Forward Transconductance	V <sub>DS</sub> =15V, I <sub>D</sub> =5A	--	9.5	--	S
C <sub>iss</sub>	Input Capacitance	V <sub>GS</sub> = 0V V <sub>DS</sub> = 25V f = 1.0MHz	--	1500	--	pF
C <sub>oss</sub>	Output Capacitance		--	120	--	
C <sub>rss</sub>	Reverse Transfer Capacitance		--	4	--	

Resistive Switching Characteristics						
Symbol	Parameter	Test Conditions	Rating			Units
			Min.	Typ.	Max.	
t <sub>d(ON)</sub>	Turn-on Delay Time	I <sub>D</sub> =10A V <sub>DD</sub> = 325V R <sub>G</sub> =10Ω	--	26	--	ns
t <sub>r</sub>	Rise Time		--	21	--	
t <sub>d(OFF)</sub>	Turn-Off Delay Time		--	50	--	
t <sub>f</sub>	Fall Time		--	24	--	
Q <sub>g</sub>	Total Gate Charge	I <sub>D</sub> =10A V <sub>DD</sub> =520V V <sub>GS</sub> = 10V	--	30	--	nC
Q <sub>gs</sub>	Gate to Source Charge		--	8	--	
Q <sub>gd</sub>	Gate to Drain ("Miller") Charge		--	12	--	



Source-Drain Diode Characteristics						
Symbol	Parameter	Test Conditions	Rating			Units
			Min.	Typ.	Max.	
$I_S$	Continuous Source Current (Body Diode)		--	--	10	A
$I_{SM}$	Maximum Pulsed Current (Body Diode)		--	--	40	A
$V_{SD}$	Diode Forward Voltage	$I_S=10A, V_{GS}=0V$	--	--	1.5	V
$t_{rr}$	Reverse Recovery Time	$I_S=10A, T_J = 25^\circ C$ $dI_F/dt=100A/us,$ $V_{GS}=0V$	--	528	--	ns
$Q_{rr}$	Reverse Recovery Charge		--	3220	--	nC
$I_{RRM}$	Reverse Recovery Current		--	12.2	--	A
Pulse width $t_p \leq 300\mu s, \delta \leq 2\%$						

Symbol	Parameter	Typ.	Units
$R_{\theta JC}$	Junction-to-Case	3.13	$^\circ C/W$
$R_{\theta JA}$	Junction-to-Ambient	120	$^\circ C/W$

<sup>a1</sup>: Repetitive rating; pulse width limited by maximum junction temperature

<sup>a2</sup>:  $L=30mH, I_{AS}=6.00A, V_{DD}=80V, R_G=25\Omega,$  starting  $T_J=25^\circ C$ ;

<sup>a3</sup>:  $I_{SD}=10A, di/dt \leq 100A/us, V_{DD} \leq BV_{DS},$  Start  $T_J=25^\circ C$



Characteristics Curve:

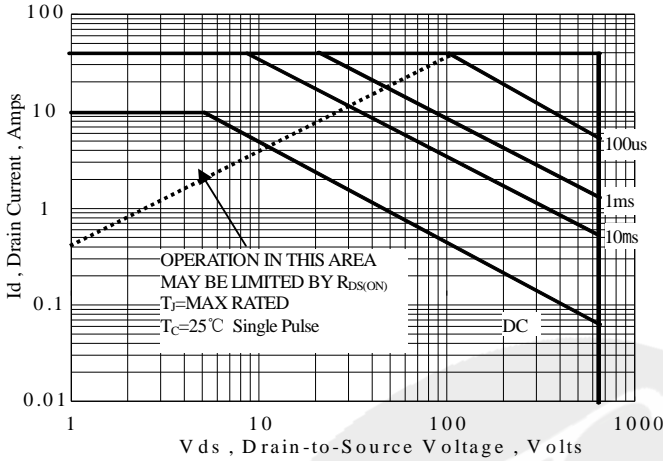

Figure 1 Maximum Forward Bias Safe Operating Area

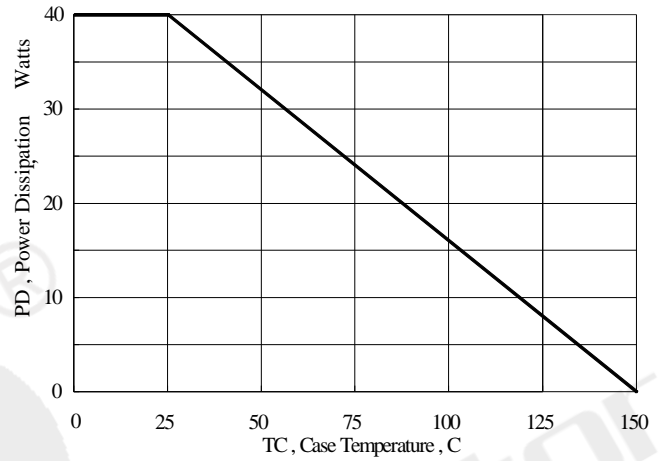

Figure 2 Maximum Power Dissipation vs Case Temperature

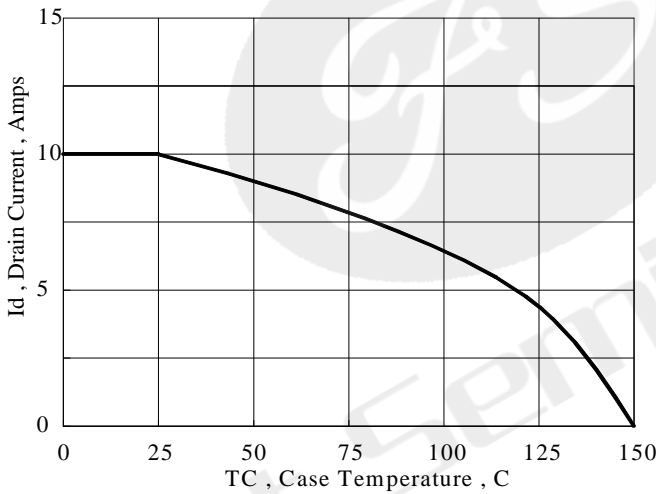

Figure 3 Maximum Continuous Drain Current vs Case Temperature

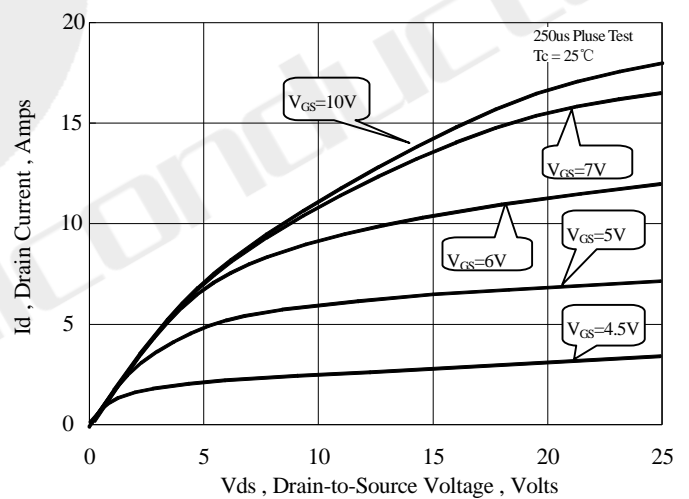

Figure 4 Typical Output Characteristics

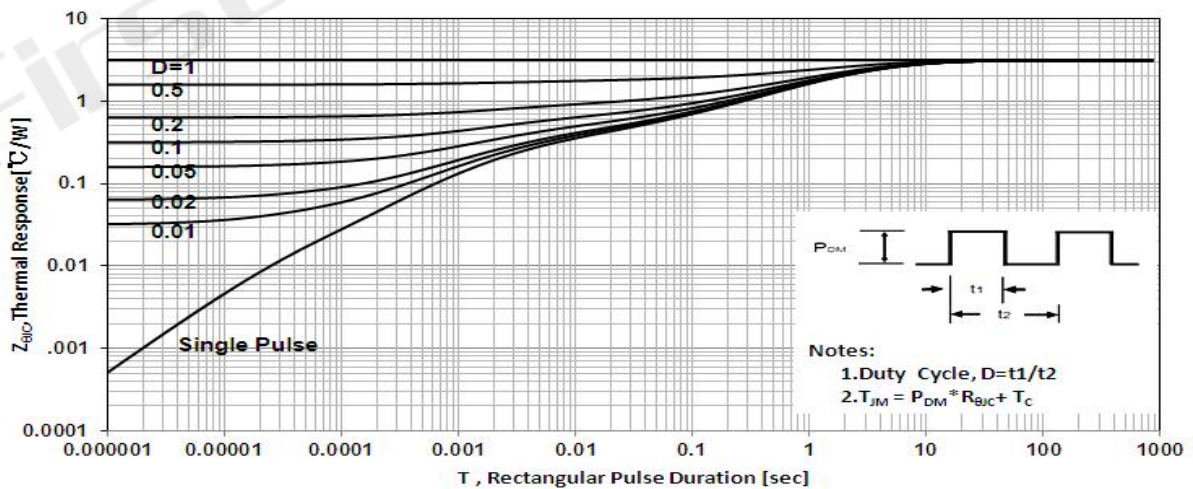

Figure 5 Maximum Effective Thermal Impedance, Junction to Case

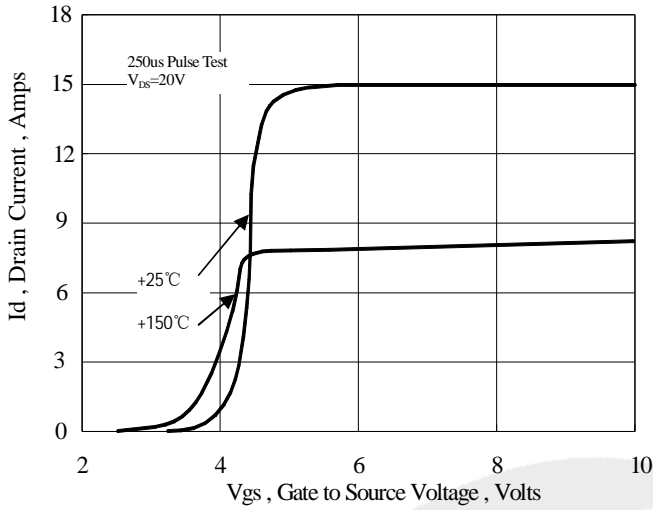

Figure 6 Typical Transfer Characteristics

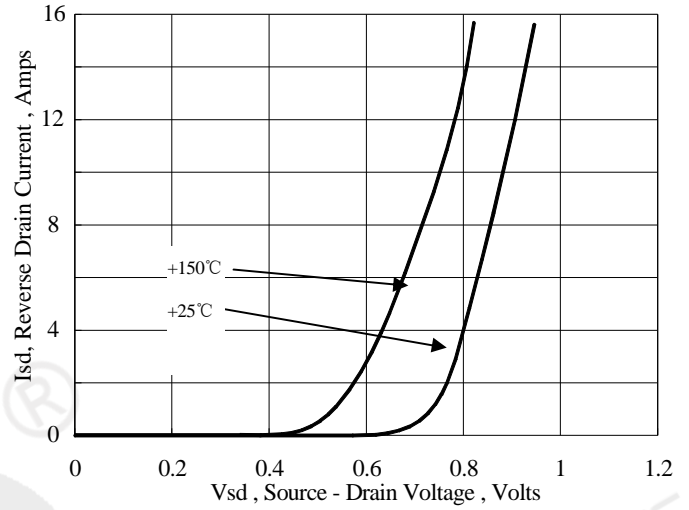

Figure 7 Typical Body Diode Transfer Characteristics

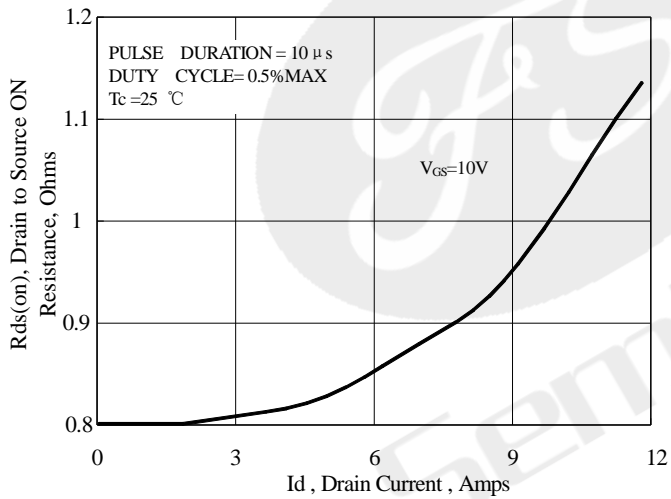

Figure 8 Typical Drain to Source ON Resistance vs Drain Current

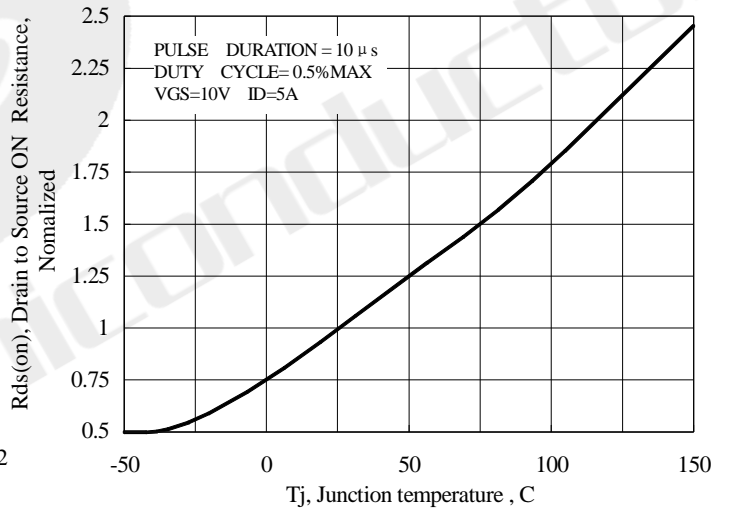

Figure 9 Typical Drain to Source on Resistance vs Junction Temperature

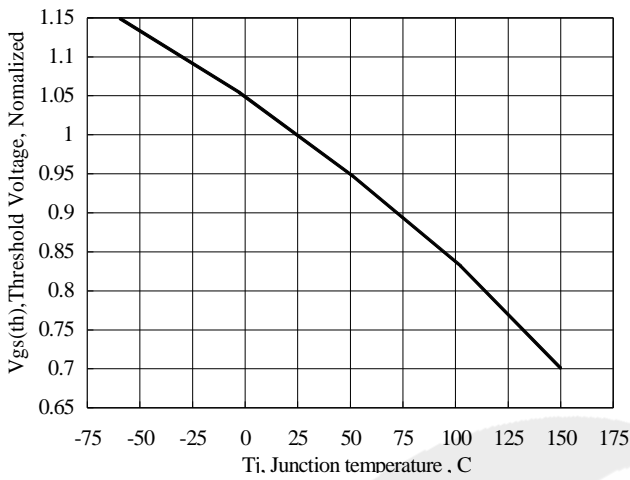

Figure 10 Typical Theshold Voltage vs Junction Temperature

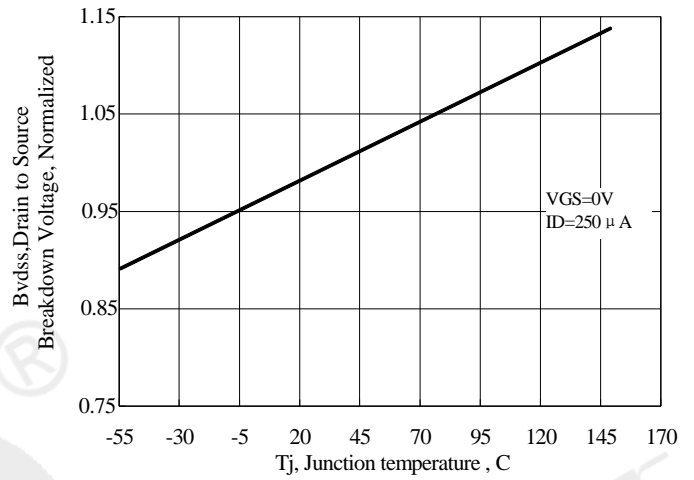

Figure 11 Typical Breakdown Voltage vs Junction Temperature

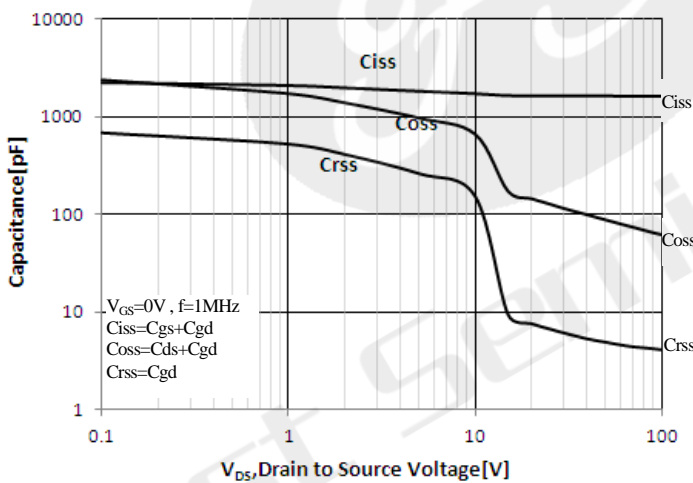

Figure 12 Typical Capacitance vs Drain to Source Voltage

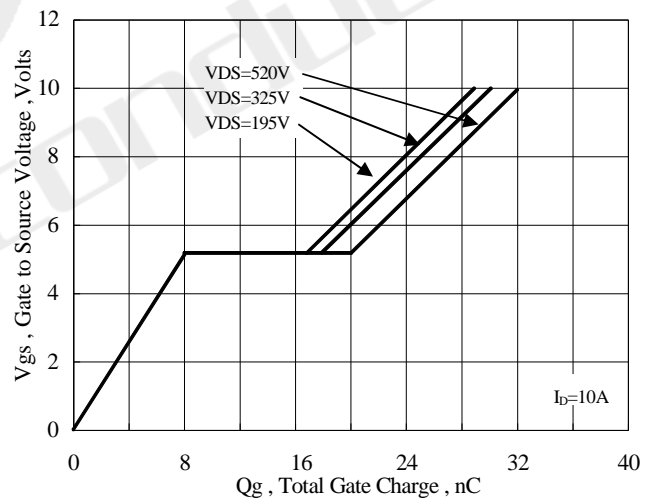

Figure 13 Typical Gate Charge vs Gate to Source Voltage

Test Circuit and Waveform

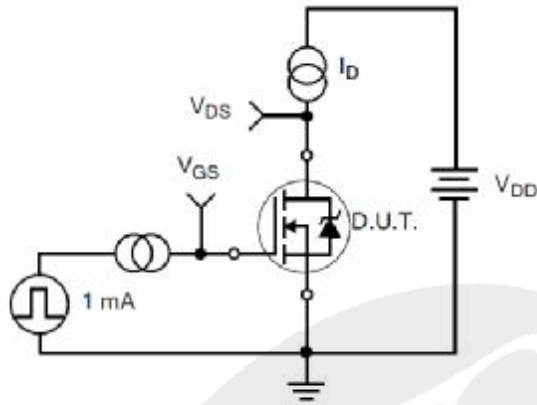

Figure 17. Gate Charge Test Circuit

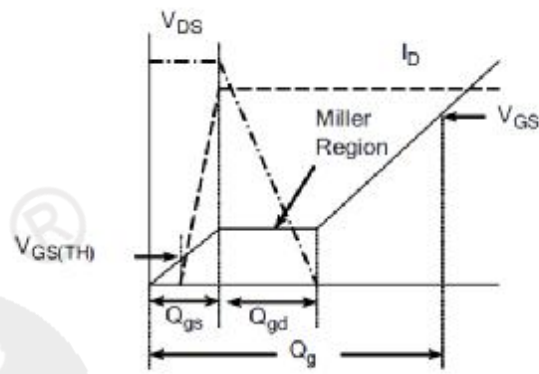

Figure 18. Gate Charge Waveform

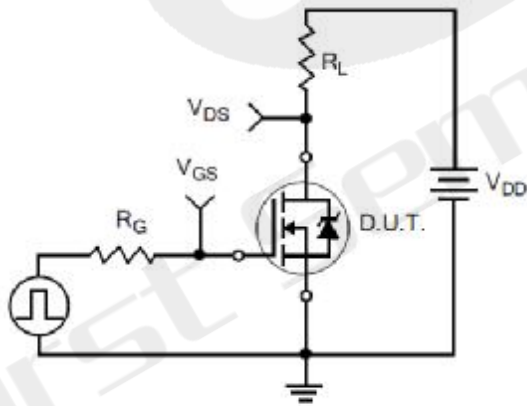

Figure 19. Resistive Switching Test Circuit

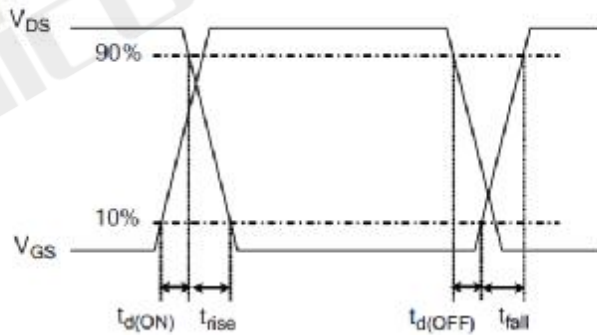

Figure 20. Resistive Switching Waveforms

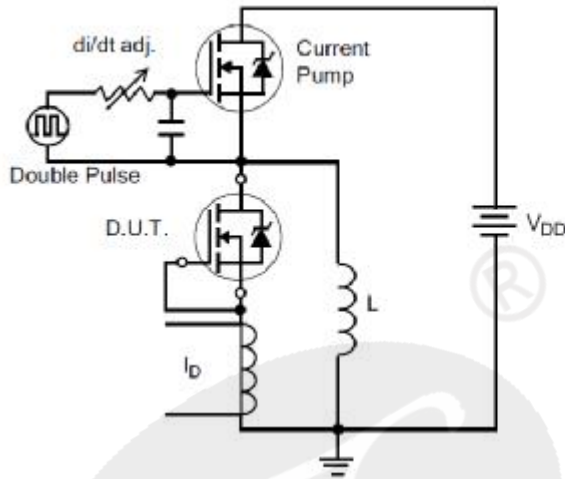

Figure 21. Diode Reverse Recovery Test Circuit

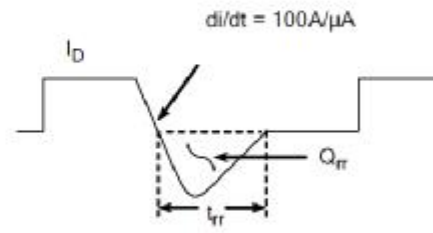

Figure 22. Diode Reverse Recovery Waveform

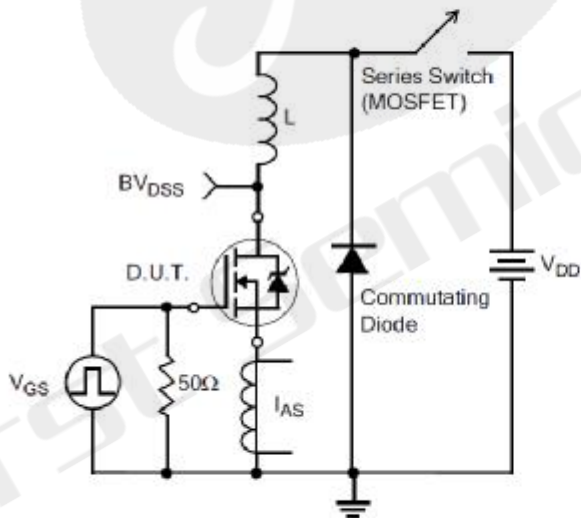

Figure 23. Unclamped Inductive Switching Test Circuit

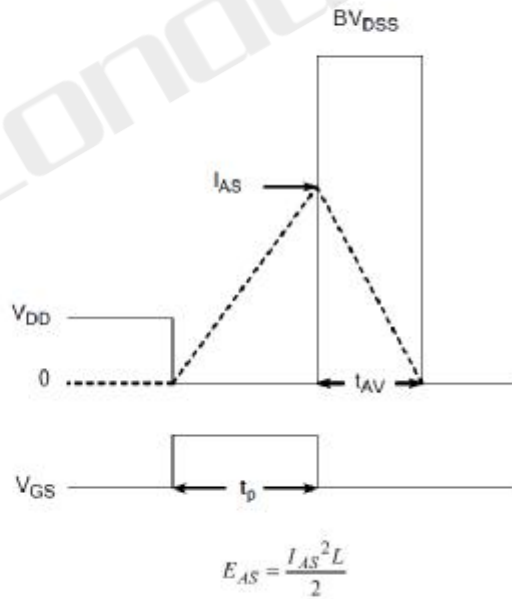
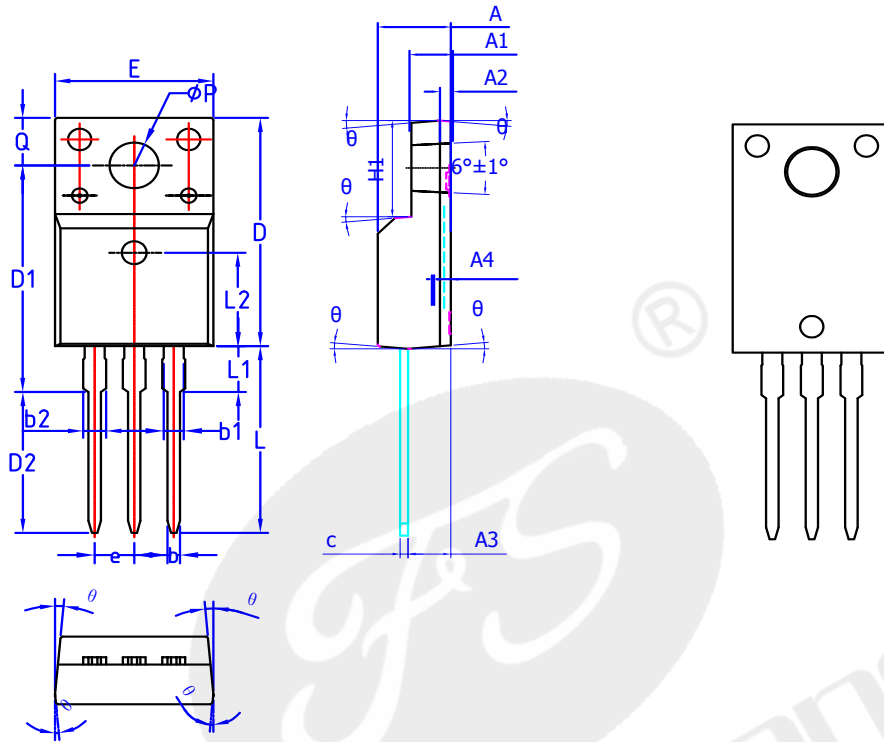

Figure 24. Unclamped Inductive Switching Waveforms



Package Information

TO-220F



Units: mm  
COMMON DIMENSIONS  
(UNITS OF MEASURE=MILLIMETER)

SYMBOL	MIN	NOM	MAX
A	4.50	4.70	4.90
A1	2.34	2.54	2.74
A2	0.70 REF		
A3	2.56	2.76	2.96
b	0.70	0.80	0.90
b1	1.17	1.2	1.25
b2	1.17	1.2	1.25
c	0.45	0.50	0.60
D	15.67	15.87	16.07
D1	15.55	15.75	15.95
D2	10.0	10.2	10.4
E	9.96	10.16	10.36
e	2.54BSC		
H1	6.48	6.68	6.88
L	12.68	12.98	13.28
L1	-	-	3.50
L2	6.50REF		
phi P	3.08	3.18	3.28
Q	3.20	3.30	3.40
theta 1	1°	3°	5°
A4	0.53	0.56	0.59



Declaration

- FIRST reserves the right to change the specifications, the same specifications of products due to different packaging line mold, the size of the appearance will be slightly different, shipped in kind, without notice! Customers should obtain the latest version information before ordering, and verify whether the relevant information is complete and up-to-date.
- Any semiconductor product under certain conditions has the possibility of failure or failure, The buyer has the responsibility to comply with safety standards and take safety measures when using FIRST products for system design and manufacturing, To avoid To avoid potential failure risks, which may cause personal injury or property damage!
- Product promotion endless, our company will wholeheartedly provide customers with better products!

**ATTACHMENT**

Revision History

Date	REV	Description	Page
2018.01.01	1.0	Initial release	