

Application Description

These Cutler-Hammer® ampere and horsepower rated devices from Eaton's electrical business are designed for service in applications such as Refrigeration, Air Conditioning and Resistance Heating and are manufactured to traditional Cutler-Hammer standards for quality and reliability. They are subjected to stringent quality assurance inspections and

testing procedures. The life expectancy, both electrical and mechanical, will meet or exceed industry performance requirements for Definite Purpose devices.

If more detailed technical information is required — specifications, ratings, etc. — contact your local Eaton distributor or sales office.

Catalog Number Selection

Table 1. Definite Purpose Control Catalog Numbering System

Model		Bulk Packaging	
C = Contactor	25 = Non-reversing Contactors & Starters	Blank = individual pkg.	-84 = 20 pc./pkg. (C25D_)
A = Three-Phase Starter	27 = Non-reversing Starters	-84 = 50 pc./pkg. (C25A_, C25B_, C25C_)	-86 = Rotate coil terminals 180° for 15A – 50A Contactors
B = Single-Phase Starter	29 = Non-reversing Starters		
	65 = Reversing Contactors		
Type		Fuse Blocks	
25 = Non-reversing Contactors & Starters		161 = Class M, 600V, 30A	
27 = Non-reversing Starters		237 = Class G, 300V, 15A	
29 = Non-reversing Starters		238 = Class G, 300V, 20A	
65 = Reversing Contactors		231 = Class G, 300V, 30A	
		232 = Class G, 300V, 60A	
		361 = Class J, 600V, 30A	
		362 = Class J, 600V, 60A	
		431 = Class T, 300V, 30A	
		432 = Class T, 300V, 60A	
		461 = Class T, 600V, 30A	
		462 = Class T, 600V, 60A	
		521 = Class H, 250V, 30A	
		522 = Class H, 250V, 60A	
		621 = Class R, 250V, 30A	
		622 = Class R, 250V, 60A	
Contactor Frame Size		Auxiliary Contacts (Side Mount)	
A = Compact 1-Pole		A = 1NO Pressure Plate	
B = Compact 2-Pole		B = 1NC Pressure Plate	
C = Compact 1-Pole W/Shunt		C = 1NO-1NC Pressure Plate	
D = 15 – 50A, 2- and 3-Pole		D = 2NO Pressure Plate	
E = 25 – 40A, 4-Pole		E = 2NC Pressure Plate	
F = 60 – 75A, 2- and 3-Pole		F = 1NO Pressure Plate and QC	
G = 90A, 2- and 3-Pole		G = 1NC Pressure Plate and QC	
H = 120A, 2- and 3-Pole		H = 1NO-1NC Pressure Plate and QC	
K = 200 and 300A, 3-Pole		J = 2NO Pressure Plate and QC	
L = 360A, 3-Pole		K = 2NC Pressure Plate and QC	
For Starters Only		L = 1NO-1NC Snap Switch QC Only	
C = Common Control Wiring		M = 2NO-2NC Snap Switch QC Only	
S = Separate Control Wiring			
Enclosure Type		Coil Selection	
N = Open with Metal Mounting Plate		A = 110 – 120V AC, 50/60 Hz	
R = Open with DIN Rail Mounting Adapter (2- and 3-Pole, 15 – 50A Contactors Only)		B = 208 – 240V AC, 50/60 Hz	
G = NEMA Type 1 Enclosed		C = 440 – 480V AC, 50/60 Hz	
		D = 550 – 600V AC, 50/50 Hz	
		H = 277V AC, 60 Hz	
		J = 220 – 240 V AC, 50/60 Hz	
		L = 380 – 415V AC, 50 Hz	
		R = 12V AC, 50/60 Hz	
		T = 24V AC, 50/60 Hz	
		1R = 12V DC	
		1T = 24V DC	
		1W = 48V DC	
		1A = 120V DC	
Power Terminals		Current Rating	
A = Binding Head Screw		15 = 15A	
B = Binding Head Screw and Quick Connect Terminals (side by side)		25 = 25A	
C = Screw/Pressure Plate ①		30 = 30A	
D = Screw/Pressure Plate and Quick Connect Terminals (side by side) ①		40 = 40A	
E = Box Lugs (Posidrive Setscrew)		50 = 50A	
F = Box Lugs (Posidrive Setscrew) and Quick Connect Terminals (side by side)		60 = 60A	
G = Binding Head Screw and Quick Connect Terminals (vertical in-line)		75 = 75A	
H = Screw/Pressure Plate and Quick Connect Terminals (vertical in-line) ①		90 = 90A	
J = Box Lugs (Posidrive Setscrew) and Quick Connect Terminals (vertical in-line)		120 = 120A	
K = Box Lugs (Hex Socket Allen Head Setscrew)		200 = 200A	
L = Box Lugs (Hex Socket Allen Head Setscrew) and Quick Connect Terminals (side by side)		300 = 300A	
M = Box Lugs (Hex Socket Allen Head Setscrew) and Quick Connect Terminals (vertical in-line)		360 = 360A	
① Not available on 50A devices.			
No. of Poles			
1 = 1-Pole			
2 = 2-Pole			
3 = 3-Pole			
4 = 4-Pole			

Contents

Description	Page
Compact 1- and 2-Pole Contactors 20 – 40A	
Product Description	3
Standards and Certifications	3
Technical Data — Specifications	3
Options	3
Dimensions	4
Product Selection	4



Compact 2-Pole

Product Description

Cutler-Hammer® 20 – 40A, single- and double-pole, Type C25 contactors from Eaton’s electrical business feature a compact, efficient design with a low VA coil and straight-through wiring. New contactor housing design effectively limits dust and other contaminants from magnet structure — reduces or eliminates noise. These economically priced, UL recognized/CSA certified, ampere rated devices are well suited for use in heating/air conditioning, refrigeration, data processing and food service applications.

Standards and Certifications

- UL Recognized Components: UL File Number E1491, Guides NLDX2 and NLDX8
- CSA Certified Components: CSA C22.2 No. 14-05, File Number 238083 Class 3211 84
- IEC 60947-4-1
- EN 60947-4-1
- ARI 780/790 Standard
- RoHS Compliance



Technical Data — Specifications

- Insulation Voltage: 690V
- Current Rated and hp/kW Rated
- Contacts: Double Break
- Magnet Coil: Class F, 155°C
- Contact Arc Covers are standard on all Contactors
- Standard Power Terminals —
 - 5/16" Hex Washer Head Screws
 - Quad (4) Quick Connect Terminals on all Line and Load Terminals
 - Box Lugs available as option
- Contactors are marked with Line and Load Terminal Designations
- Operating Temperature Range: -13 to 158°F (-25 to 70°C)
- Terminal Wire Range —
 - Hex Washer Head Screws: 16 – 10 AWG, 30 lb-in torque rating
 - Box Lugs: 16 – 10 AWG, 35 lb-in torque rating; 8 AWG, 40 lb-in torque rating; 6 – 4 AWG, 45 lb-in torque rating
- Mounting Position: Vertical, Horizontal or Tabletop

Table 2. Coil Characteristics

AC Coil Voltage 50/60 Hz	Max. Inrush VA	Max. Sealed VA	Max. Sealed Watts
One-Pole			
24	33	6	2
120	33	6	2
208/240	33	6	2
277	33	6	2
Two-Pole			
24	41	6.5	3
120	41	6.5	3
208/240	41	6.5	3
277	41	6.5	3
480	41	6.5	3

Options

Table 3. Compact Options — Factory Installed

Description	Adder U.S. \$
Box lugs with quick connects for 20 – 40A contactors:	
1-Pole	8.
1-Pole with shunt	8.
2-Pole	8.
To order replace letter in the 6th position of Catalog Number with letter F. EXAMPLE: C25BNF240A	

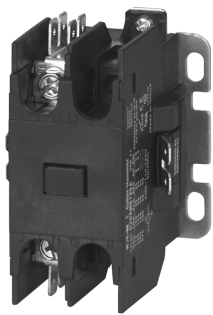

Compact 1-Pole

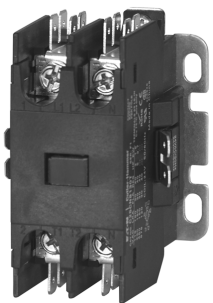

Compact 1-Pole with Shunt

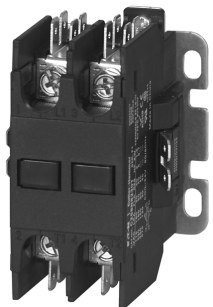

Compact 2-Pole

Product Selection

When Ordering Specify

- Catalog Number plus Magnet Coil Suffix.
- Modify Catalog Number for any options required — see factory installed Options **Page 3**.

Table 4. Catalog Numbering System

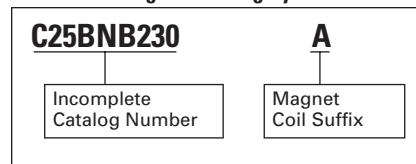

Table 5. Compact Contactors Product Selection— Open Type

Ampere Ratings ①					Max. Motor Horsepower	Max. Motor Kilowatts	Catalog Number ②③	Price U.S. \$		
Inductive Full Load	Resistive	Locked Rotor								
		240 – 277V	480V	600V	115V	230V	115V	230V		
Single-Pole										
25	30	150	50	40	2	3	1.5	2.2	C25ANB125_	51.00
30	40	150	75	50	2	5	1.5	3.7	C25ANB130_	60.50
40	50	240	200	160	3	7-1/2	2.2	5.5	C25ANB140_	74.50
Single-Pole with Shunt										
25	30	150	50	40	2	3	1.5	2.2	C25CNB125_	54.50
30	40	150	75	50	2	5	1.5	3.7	C25CNB130_	63.00
40	50	240	200	160	3	7-1/2	2.2	5.5	C25CNB140_	77.00
Double-Pole										
20	30	120	100	80	1-1/2	3	1.1	2.2	C25BNB220_	57.00
25	35	150	125	100	2	3	1.5	2.2	C25BNB225_	65.00
30	40	150	125	100	2	5	1.5	3.7	C25BNB230_	74.50
40	50	240	200	160	3	7-1/2	2.2	5.5	C25BNB240_	91.50

- ① Rating per pole.
- ② Incomplete Catalog Number. Replace underscore (_) in Catalog Number with Coil Suffix letter from **Table 6**.
- ③ Bulk pack quantities are available in quantities of 50, contact local sales office.

Table 6. Magnet Coil Selection

AC Coil Voltage 50/60 Hz	Coil Suffix
24	T
110 – 120	A
208 – 240	B
277	H
380 – 415 (50 Hz); 440 – 480 (60 Hz)	C

Dimensions

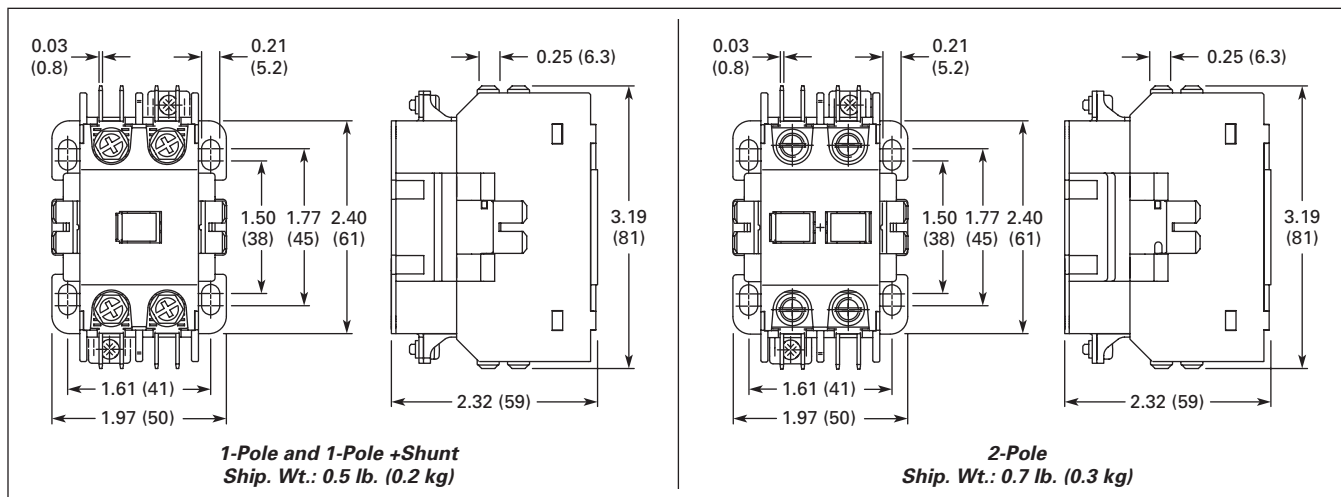
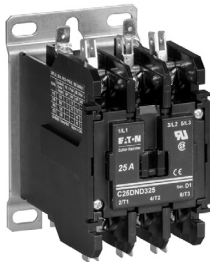

Figure 1. Compact Approximate Dimensions in Inches (mm) and Shipping Weights

Technical Data **Page 3**
 Options..... **Page 3**
 Discount Symbol **1CD-5C**



50 mm DP Contactor

Product Description

Cutler-Hammer® Type C25 Definite Purpose Contactors 15A through 360A, from Eaton's electrical business incorporate most competitive contactor mounting dimensions into a single baseplate. Contactors are dual-rated with inductive and resistive ratings as well as horsepower and kilowatt ratings. C25 contactors are furnished with pressure plates and quick connect terminals as standard on 15, 25 and 30A devices and with box lugs and quick-connect terminals on 40, 50, 60 and 75A. Other terminal configurations are available, see **Table 14**. Contactors will accept add-on auxiliary contacts — order factory assembled or as kits for field installation.

The separately available snap-on mechanical interlock permits interlocking two contactors for reversing or two-speed applications.

Contactors rated 15 – 50A only are available with DIN rail mount as a factory installed option.

Standards and Certifications

- UL Recognized Components
UL File #E-1491, Guide NLDX2
- CSA Certified Components
File #LR353, Class 3211 04, 481301 & 122201
- IEC 60947-4-1
- EN 60947-4-1



- RoHS Compliance (15A to 50A Only)



Technical Data and Specifications

- Magnet coil:
 - Class B (C25E, F, G, H and K), 130°C
 - Class F (C25D and L), 155°C
 - Class H (C25D), 180°C (Available as factory installed option)

- Contacts: Double break
- Coil terminals: 10 – 14 AWG
- Ambient temperature: 150°F (65°C) maximum
- UL recognized, CSA certified and conform to ARI 780
- CE mark
- Terminal wire range:
 - #8–32 binding head screw: 14 – 12 AWG (one conductor-solid)
 - #8–32 screw/pressure plate:
 - 14 – 8 AWG (one conductor)
 - 14 – 8 AWG (two conductors)
 - Box lugs — 15 – 50A:
 - # 2 posidrive screw or 5/32 hex socket screw
 - Upper Level: 14 – 4 AWG (one conductor)
 - Lower Level: 14 – 6 AWG (one conductor)

- Box lugs — 60 – 75A
 - Upper Level: 14 – 2 AWG
 - Lower Level: 14 – 6 AWG
- Note:** The box lugs on the 15 – 75A device can accept two conductors per pole.
- Box lugs — 90A: 1/0 – 14 AWG
- Box lugs — 120A: 3/0 – 8 AWG
- Box lugs — 200 – 300A: 350 MCM – 6 AWG
- Box lugs — 360A: 750 MCM – 2 AWG

Table 7. Lighting Duty Ratings (25A to 50A Only)

C25D_ Inductive Rating	Tungsten & Ballast (480V)
25A	30A
30A	40A
40A	50A
50A	60A

Table 8. IEC/CE Ratings (IEC 60947-4-1, EN 60947-4-1) for 15A through 50A C25D_ Contactors

C25D_ Inductive Rating	AC-1 (Ic)		AC-3 (Ie)		AC-4 (Ie)		AC-8a	
	480V	600V	480V	600V	480V	600V	480V	600V
15A	20A	20A	15A	15A	15A	—	15A	15A
25A	30A	30A	25A	25A	25A	—	25A	25A
30A	40A	40A	30A	30A	30A	—	30A	30A
40A	50A	—	40A	—	40A	—	40A	—
50A	65A	65A	50A	50A	50A	—	50A	50A

Table 9. DC Ratings (15A to 50A Only)

Voltage	2-Pole, 15 – 30A Inductive			2-Pole, 40A Inductive			3-Pole, 15 – 30A Inductive			3-Pole, 40A Inductive		
	UL/CSA		DC-3/DC-5	UL/CSA		DC-3/DC-5	UL/CSA		DC-3/DC-5	UL/CSA		DC-3/DC-5
	FLA	hp	I _e	FLA	hp	I _e	FLA	hp	I _e	FLA	hp	I _e
240V DC 3 Poles in Series	—	—	—	—	—	—	4	3/4	4	5	1	5
120V DC 3 Poles in Series	—	—	—	—	—	—	8	3/4	8	10	1	10
120V DC 2 Poles in Series	5.5	1/2	5.5	8	3/4	8	5.5	1/2	5.5	8	3/4	8
120V DC per Pole	2	1/10	2	3.5	1/4	3.5	2	1/10	2	3.5	1/4	3.5
24V DC per Pole	15	—	15	20	—	20	15	—	15	20	—	20

Table 10. Contactor Torque Ratings

Contactor Size	Terminal	Wire Range	Tightening Torque
15 – 50A ①	8–32 Binding Head Screw	12 – 14 AWG	22 lb-in
	Screw/Pressure Plate	8 – 14 AWG	15 lb-in
	Box Lug	12 – 14 AWG 10 AWG 8 AWG 4 – 6 AWG	15 lb-in 25 lb-in 40 lb-in 45 lb-in
60 – 75A ②	Box Lug	10 – 14 AWG 8 AWG 3 – 6 AWG	40 lb-in 45 lb-in 50 lb-in
90A	Box Lug	1/0 – 14 AWG	60 lb-in
120A	Box Lug	8 AWG 4 – 6 AWG 3 – 1/0 AWG	40 lb-in 45 lb-in 50 lb-in
200 – 300A	Box Lug	6 – 350 MCM	200 lb-in
360A	Box Lug	2 – 750 MCM	550 lb-in

① The box lugs on the 15 – 50A device can accept 2 conductors per pole, the upper section will accept 4 – 14 AWG and the lower section will accept 6 – 14 AWG.

② The box lugs on the 60 – 75A device can accept 2 conductors per pole, the upper section will accept 3 – 14 AWG and the lower section will accept 6 – 14 AWG.

Product Selection

When Ordering Specify

- Catalog Number plus Magnet Coil Suffix, below.

- Modify Catalog Number for any options required — see Options, **Page 7**.
- Catalog Numbers of accessory kits required, **Page 7**.

Table 11. Catalog Numbering System

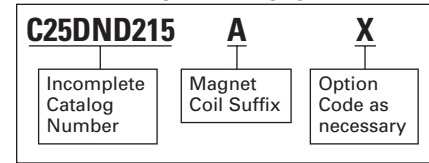

Table 12. C25 Contactors Product Selection— Open Type

Rating, Amperes				Maximum Motor Horsepower		Maximum Motor Kilowatts		Number of Poles	Open Type with Metal Mounting Plate		Open Type with DIN Rail Adapter					
Inductive Full Load	Resistive per Pole	Line Voltage	Locked Rotor	1-Phase	3-Phase	1-Phase	3-Phase		Catalog Number ①②	Price U.S. \$	Catalog Number ①②	Price U.S. \$				
15	20	115	90	3/4	—	0.40	—	2	C25DND215_	68.00	C25DRD215_	65.00				
		230	90	2	3	1.5	2.2						C25DND315_	77.00	C25DRD315_	73.00
		460	75	—	5	—	3.7									
		575	60	—	5	—	3.7									
25	35	115	150	2	—	1.5	—	2	C25DND225_	77.00	C25DRD225_	73.00				
		230	150	3	7-1/2	2.2	5.5						C25DND325_	85.00	C25DRD325_	81.00
		460	125	—	10	—	7.5									
		575	100	—	10	—	7.5									
30	40	115	180	2	—	1.5	—	2	C25DND230_	85.00	C25DRD230_	81.00				
		230	180	5	10	3.7	7.5						C25DND330_	92.50	C25DRD330_	88.00
		460	150	—	15	—	11									
		575	120	—	15	—	11									
40	50	115	240	3	—	2.2	—	2	C25DNF240_	101.00	C25DRF240_	96.00				
		230	240	7-1/2	10	5.5	7.5						C25DNF340_	112.00	C25DRF340_	106.00
		460	200	—	20	—	15									
		575	160	—	20	—	15									
50	65	115	300	3	—	2.2	—	2	C25DNJ250_	180.00	C25DRJ250_	171.00				
		230	300	10	15	7.5	11						C25DNJ350_	197.00	C25DRJ350_	187.00
		460	250	—	30	—	22									
		575	200	—	30	—	22									
60	75	115	360	5	—	3.7	—	2	C25FNF260_	215.00	NA	—				
		230	360	10	20	7.5	15						C25FNF360_	235.00	NA	—
		460	300	—	40	—	30									
		575	240	—	40	—	30									
75	90	115	450	5	—	3.7	—	2	C25FNF275_	291.00	NA	—				
		230	450	15	20	11	18.5						C25FNF375_	312.00	NA	—
		460	375	—	50	—	37									
		575	300	—	50	—	37									
90	120	115	540	7-1/2	—	5.7	—	2	C25GNF290_	362.00	NA	—				
		230	540	20	30	15.1	22						C25GNF390_	387.00	NA	—
		460	450	—	50	—	37									
		575	360	—	50	—	37									
120	140	230	720	—	—	—	—	3	C25HNE3120_	476.00	NA	—				
		460	720	—	—	—	—									
		575	570	—	—	—	—									
200	200	240	1200	—	—	—	—	3	C25KNE3200_	1,180.00	NA	—				
		480	1200	—	—	—	—									
		600	1000	—	—	—	—									
300	300	240	1800	—	—	—	—	3	C25KNE3300_	2,025.00	NA	—				
		480	1800	—	—	—	—									
		600	1500	—	—	—	—									
360	360	240	2320	—	—	—	—	3	C25LNE3360_	2,550.00	NA	—				
		480	2320	—	—	—	—									
		600	1900	—	—	—	—									

- ① Incomplete Catalog Number. Replace underscore (_) in Catalog Number with Magnet Coil Suffix from table below.
- ② Carton quantities including 20 individually packaged units are available for 2- and 3-pole units through 60A inductive.
- ③ Contactors with DC coils (only available up to 75A) include an early break NC auxiliary contact, C320KGD1. See **Page 34** for more details.
- ④ Available only for 15A through 75A contactors and 4-pole contactors.
- ⑤ Available through 75A.
- ⑥ Available through 120A.
- ⑦ Available 120 – 360A.
- ⑧ Available 15 – 90A, others 240V.
- ⑨ Available through 50A.

Table 13. Magnet Coil Selection

Voltage		Coil Suffix	
60 Hertz	50 Hertz		
AC ⑩			
12 ⑤	12	R T A E B J H L C D	
24 ⑥	24		
110 – 120 ⑦	110 – 120 ⑦		
208 ⑦	—		
208 – 240 ⑧	208 – 240		
240 ⑨	220		
277	—		
—	380 – 415		
440 – 480	440 – 480		
550 – 600	550 – 600		
DC ⑪			
12	—		1R 1T 1W 1A ⑫
24	—		
48	—		
120	—		

- ⑩ 104 – 120V 50/60 Hz for 60A, 75A and all 4-Pole Contactors (25A – 40A).
- ⑪ Class H AC Coils available as option for 15A – 50A Contactor. Add 2 before AC Coil Suffix letter.

Technical Data **Pages 5, 35**
 Options **Page 7**
 Accessories **Page 7**
 Dimensions **Page 31**
 Discount Symbol **1CD-5C**