

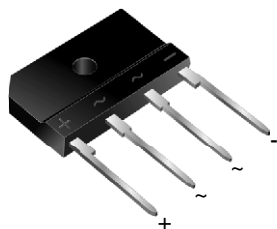

## Single-Phase Single In-Line Bridge Rectifier

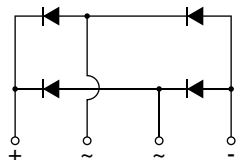

Case Style GSIB-3S



### FEATURES

- UL recognition file number E312394 (QQX2)
- Ideal for printed circuit boards
- High surge current capability
- High case dielectric strength of 1500 V<sub>RMS</sub>
- Solder dip 260 °C, 40 s
- Compliant to RoHS directive 2002/95/EC and in accordance to WEEE 2002/96/EC

RoHS  
COMPLIANT

### TYPICAL APPLICATIONS

General purpose use in ac-to-dc bridge full wave rectification for monitor, TV, printer, switching mode power supply, adapter, audio equipment, and home appliances applications.

### MECHANICAL DATA

**Case:** GSIB-3S

Epoxy meets UL 94 V-0 flammability rating

**Terminals:** Matte tin plated leads, solderable per J-STD-002 and JESD 22-B102

E3 suffix for consumer grade, meets JESD 201 class 1A whisker test

**Mounting Torque:** 10 cm-kg (8.8 inches-lbs) max.

**Recommended Torque:** 5.7 cm-kg (5 inches-lbs)

### PRIMARY CHARACTERISTICS

$I_{F(AV)}$	4.0 A
$V_{RRM}$	200 V to 800 V
$I_{FSM}$	80 A
$I_R$	5 $\mu$ A
$V_F$	1.0 V
$T_J$ max.	150 °C

### MAXIMUM RATINGS ( $T_A = 25$ °C unless otherwise noted)

PARAMETER	SYMBOL	VSIB4A20	VSIB4A40	VSIB4A60	VSIB4A80	UNIT
Maximum repetitive peak reverse voltage	$V_{RRM}$	200	400	600	800	V
Maximum RMS voltage	$V_{RMS}$	140	280	420	560	V
Maximum DC blocking voltage	$V_{DC}$	200	400	600	800	V
Maximum average forward rectified output current at $T_C = 100$ °C $T_A = 25$ °C	$I_{F(AV)}$	4.0 <sup>(1)</sup> 2.3 <sup>(2)</sup>				A
Peak forward surge current single sine-wave superimposed on rated load	$I_{FSM}$	80				A
Rating for fusing ( $t < 8.3$ ms)	$I^2t$	32				A <sup>2</sup> s
Operating junction and storage temperature range	$T_J, T_{STG}$	- 55 to + 150				°C

#### Notes

(1) Unit case mounted on aluminum plate heatsink

(2) Units mounted on P.C.B. with 0.5" x 0.5" (12 mm x 12 mm) copper pads and 0.375" (9.5 mm) lead length

# VSIB4A20 thru VSIB4A80

Vishay General Semiconductor



ELECTRICAL CHARACTERISTICS (T <sub>A</sub> = 25 °C unless otherwise noted)								
PARAMETER	TEST CONDITIONS		SYMBOL	VSIB4A20	VSIB4A40	VSIB4A60	VSIB4A80	UNIT
Maximum instantaneous forward drop per diode <sup>(1)</sup>	I <sub>F</sub> = 2.0 A	T <sub>A</sub> = 25 °C	V <sub>F</sub>			1.0		V
Maximum reverse current per diode <sup>(2)</sup>	Rated V <sub>R</sub>	T <sub>A</sub> = 25 °C T <sub>A</sub> = 125 °C	I <sub>R</sub>			5.0 200		μA

**Notes**

- (1) Pulse test: 300 μs pulse width, 1 % duty cycle
- (2) Pulse test: Pulse width ≤ 40 ms

THERMAL CHARACTERISTICS (T <sub>A</sub> = 25 °C unless otherwise noted)						
PARAMETER	SYMBOL	VSIB4A20	VSIB4A40	VSIB4A60	VSIB4A80	UNIT
Maximum thermal resistance	R <sub>θJA</sub> R <sub>θJC</sub>			26 <sup>(2)</sup> 5 <sup>(1)</sup>		°C/W

**Notes**

- (1) Unit case mounted on aluminum plate heatsink
- (2) Units mounted on P.C.B. with 0.5" x 0.5" (12 mm x 12 mm) copper pads and 0.375" (9.5 mm) lead length
- (3) Recommended mounting position is to bolt down on heatsink with silicone thermal compound for maximum heat transfer with #6 screw

ORDERING INFORMATION (Example)				
PREFERRED P/N	UNIT WEIGHT (g)	PREFERRED PACKAGE CODE	BASE QUANTITY	DELIVERY MODE
VSIB4A60-E3/45	4.0	45	20	Tube

## RATINGS AND CHARACTERISTICS CURVES

(T<sub>A</sub> = 25 °C unless otherwise noted)

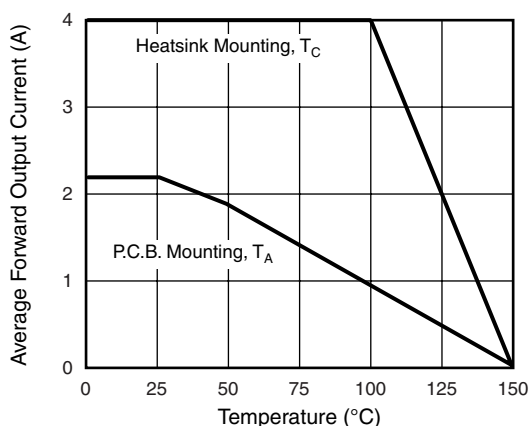

Figure 1. Derating Curve Output Rectified Current

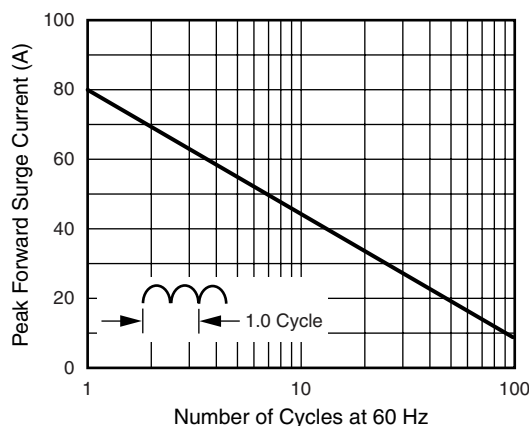

Figure 2. Maximum Non-Repetitive Peak Forward Surge Current Per Diode



# VSIB4A20 thru VSIB4A80

Vishay General Semiconductor

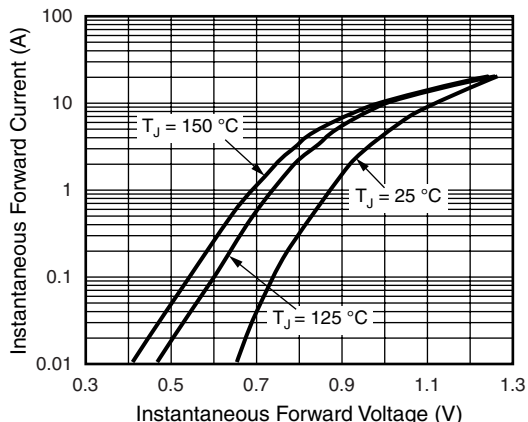

Figure 3. Typical Forward Characteristics Per Diode

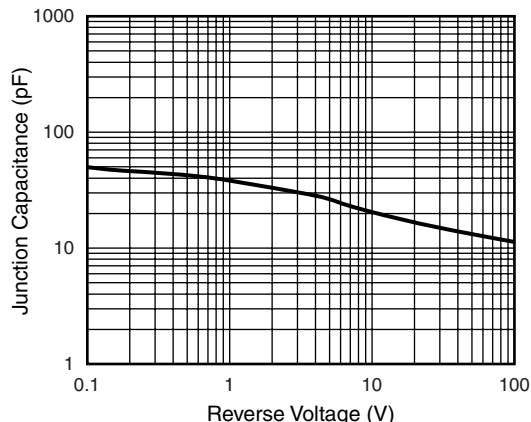

Figure 5. Typical Junction Capacitance Per Diode

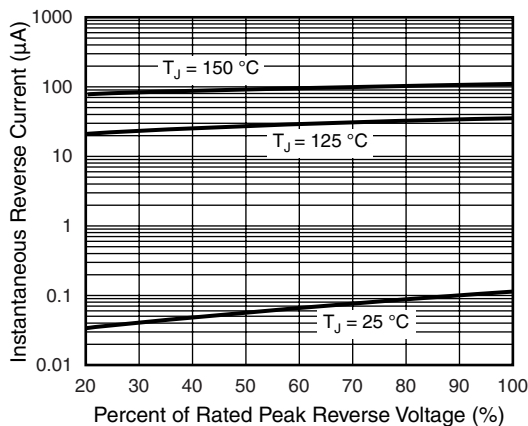

Figure 4. Typical Reverse Characteristics Per Diode

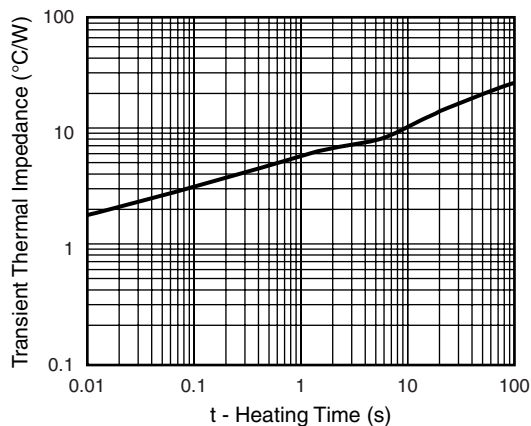
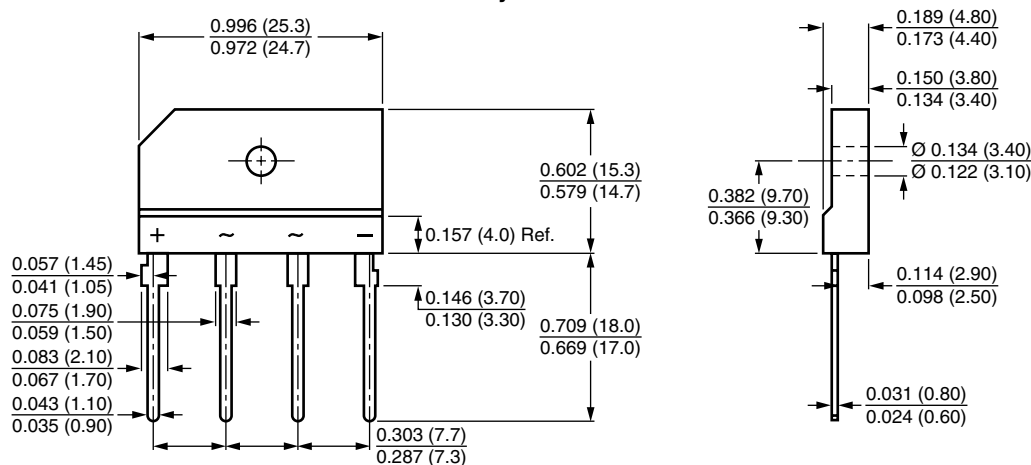

Figure 6. Typical Transient Thermal Impedance Per Diode

## PACKAGE OUTLINE DIMENSIONS in inches (millimeters)

### Case Style GSIB-3S





## Disclaimer

ALL PRODUCT, PRODUCT SPECIFICATIONS AND DATA ARE SUBJECT TO CHANGE WITHOUT NOTICE TO IMPROVE RELIABILITY, FUNCTION OR DESIGN OR OTHERWISE.

Vishay Intertechnology, Inc., its affiliates, agents, and employees, and all persons acting on its or their behalf (collectively, "Vishay"), disclaim any and all liability for any errors, inaccuracies or incompleteness contained in any datasheet or in any other disclosure relating to any product.

Vishay makes no warranty, representation or guarantee regarding the suitability of the products for any particular purpose or the continuing production of any product. To the maximum extent permitted by applicable law, Vishay disclaims (i) any and all liability arising out of the application or use of any product, (ii) any and all liability, including without limitation special, consequential or incidental damages, and (iii) any and all implied warranties, including warranties of fitness for particular purpose, non-infringement and merchantability.

Statements regarding the suitability of products for certain types of applications are based on Vishay's knowledge of typical requirements that are often placed on Vishay products in generic applications. Such statements are not binding statements about the suitability of products for a particular application. It is the customer's responsibility to validate that a particular product with the properties described in the product specification is suitable for use in a particular application. Parameters provided in datasheets and/or specifications may vary in different applications and performance may vary over time. All operating parameters, including typical parameters, must be validated for each customer application by the customer's technical experts. Product specifications do not expand or otherwise modify Vishay's terms and conditions of purchase, including but not limited to the warranty expressed therein.

Except as expressly indicated in writing, Vishay products are not designed for use in medical, life-saving, or life-sustaining applications or for any other application in which the failure of the Vishay product could result in personal injury or death. Customers using or selling Vishay products not expressly indicated for use in such applications do so at their own risk and agree to fully indemnify and hold Vishay and its distributors harmless from and against any and all claims, liabilities, expenses and damages arising or resulting in connection with such use or sale, including attorneys fees, even if such claim alleges that Vishay or its distributor was negligent regarding the design or manufacture of the part. Please contact authorized Vishay personnel to obtain written terms and conditions regarding products designed for such applications.

No license, express or implied, by estoppel or otherwise, to any intellectual property rights is granted by this document or by any conduct of Vishay. Product names and markings noted herein may be trademarks of their respective owners.