

BriLux 1W Light Source

BTP-183XXCQ-XX-XX



[Note 1]

Package Dimension

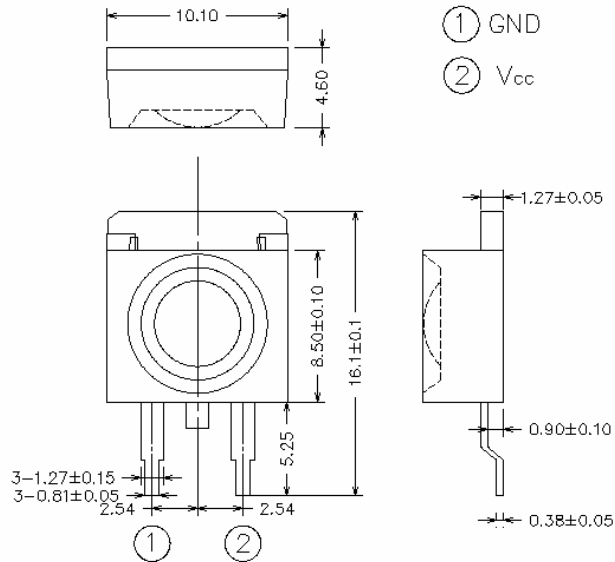

Tolerance: ± see spec Unit: mm

Features

- Highest Lumen Per Watt
- Long Operational Life
- More Energy Efficient
- IC Compatible
- Low DC Voltage
- Superior ESD Protection
- Smallest Footprint

Applications

- Accent Lighting
- Automotive Exterior/Interior Light
- High Power Back Light
- Reading Light
- Marine/Miner's Lighting
- Portable Lighting

Optical Characteristics at $T_a=25^\circ\text{C}$, $I_F=300\text{mA}$

PART NUMBER	LED CHIP	Lens Color	Wavelength/CCT Range (nm/K)		Drive Voltage	Luminous Flux @300mA(lm)	VIEW ANGLE $2\theta_{1/2}$ (deg)
	MATERIAL		Min/Max	Typ.	Typ.		
BTP-183BLCQ-XX-08	AllnGaN	Water Clear	460~475		3.40V	8 lm	60
BTP-183GBCQ-XX-08	AllnGaN	Water Clear	475~485		3.40V	8 lm	60
BTP-183WHCQ-XX-20	AllnGaN	Water Clear	5000K	8000K	3.40V	20 lm	60

Note:

1) Picture for illustration purpose only. Please refer to outline dimension for actual package size.



BriLux 1W Light Source

BTP-183XXCQ-XX-XX

Absolute Maximum Ratings at $T_a=25^{\circ}\text{C}$

Parameter	White/Blue
DC Forward Current (mA) ^[1]	300
Peak Pulsed Forward Current (mA)	500
Average Forward Current (mA)	300
Reverse Voltage (V)	5
LED Junction Temperature ($^{\circ}\text{C}$) ^[3]	120
Thermal Resistance without heatsink ($^{\circ}\text{C}/\text{W}$)	80
Storage Temperature ($^{\circ}\text{C}$)	-20 to +80
Operating Temperature ($^{\circ}\text{C}$)	-10 to +70

Application Notes:

1. Proper forward current must be observed to maintain the junction temperature below maximum rating
2. Although all products listed are class one ESD protection (+/- 1KV by HBM mode), care must be fully taken when handling products
3. Specification is subjected to change without notice.



WARNING

This range of LEDs is produced with die having a high radiant flux. Care must be taken when viewing the product at close range as the light may be intense enough to cause damage to the human eye.

Note: Industry standard procedures regarding static must be observed when handling this product.



BriLux 1W Light Source

BTP-183XXCQ-XX-XX

Typical Electro-Optical Characteristics Curves at $T_a=25^\circ\text{C}$

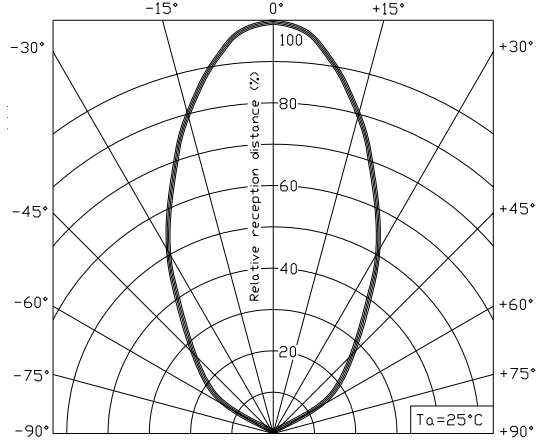
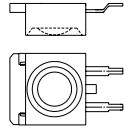
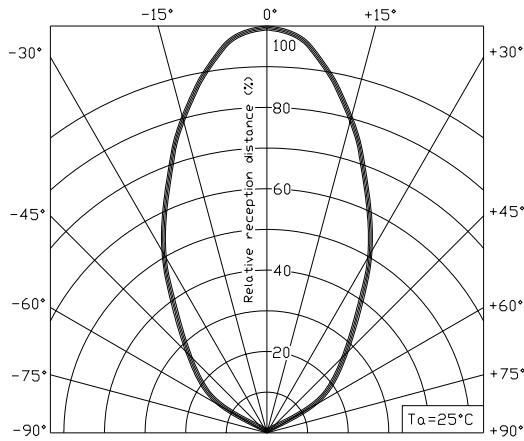
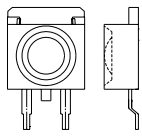

Forward Voltage vs. Forward Current

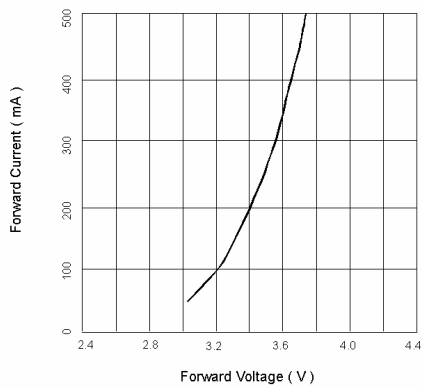

Iv (lm) Iv-If Characteristics

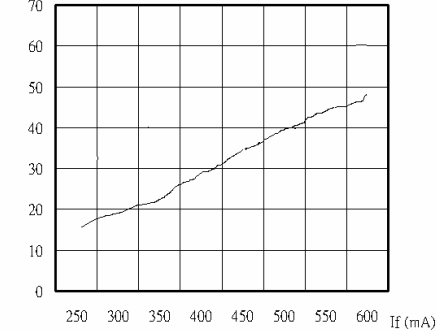

Temp-Iv

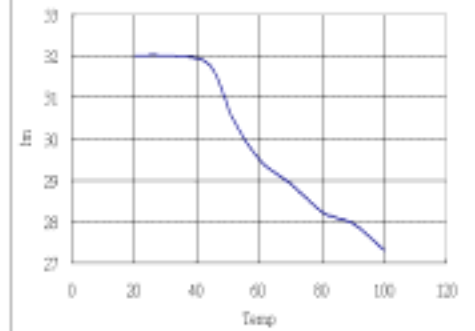

SMT Reflow Soldering Instruction

Number of reflow process shall be less than 2times and cooling process to normal temperature is required between first and second soldering process.

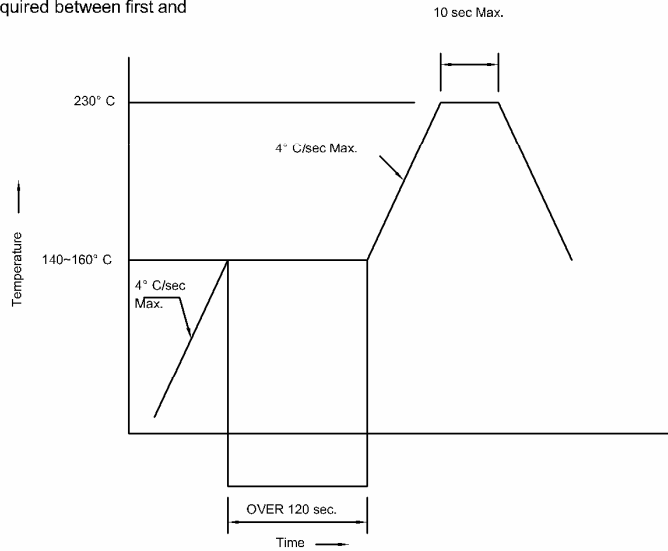

Note: The recommended maximum reflow temperature is less than 220°C

Recommended Soldering Pattern

