

■ FEATURES

- High Efficiency: Up to 92%
- 1.2MHz Constant Switching Frequency
- 3.3V Output Voltage at $I_{OUT}=100mA$ from a Single AA Cell; 3.3V Output Voltage at $I_{OUT}=400mA$ from two AA cells
- Low Start-up Voltage: 0.85V
- Integrated main switch and synchronous rectifier. No Schottky Diode Required
- 2.5V to 5V Output Voltage Range
- Automatic Pulse Skipping Mode Operation
- Tiny External Components
- $<1 \mu A$ Shutdown Current
- Antiringing Control Reduces EMI
- Space Saving 6-Pin Thin SOT23 Package

■ APPLICATIONS

- Cellular and Smart Phones
- Microprocessors and DSP Core Supplies
- Wireless and DSL Modems
- MP3 Player
- Digital Still and Video Cameras
- Portable Instruments

■ PIN CONFIGURATION

(Top View)

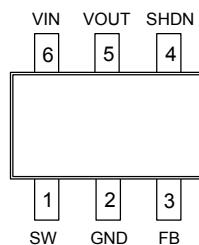

Pin Number	Pin Name	Pin Function
1	SW	Power Switch Pin. It is the switch node connection to Inductor.
2	GND	Ground Pin
3	FB	Feedback Input Pin. Connect FB to the center point of the external resistor divider. The feedback threshold voltage is 1.23V.
4	SHDN	Chip Shutdown Signal Input. Logic high is normal operation mode, Logic Low is Shutdown. Typically, this pin is connected to V_{IN} through a 1 M Ω resistor.
5	VOUT	Power Output Pin. V_{OUT} is held 0.6V below than V_{IN} in shutdown.
6	VIN	Power Supply Input. Must be closely decoupled to GND, Pin 2, with a 4.7 μF or greater ceramic capacitor.

■ GENERAL DESCRIPTION

The FSP3603 is a 1.2MHz constant frequency, current mode PWM step-up converter. It can supply 3.3V output voltage at 100mA from a single AA Cell. The device integrates a main switch and a synchronous rectifier for high efficiency without an external Schottky diode. A switching frequency of 1.2MHz allows the use of tiny, low profile inductors and ceramic capacitors. The current mode PWM operation with internal compensation provides excellent line and load transient characteristics. The FSP3603 features Pulse Skipping Mode operation at light loads to avoid unacceptable ripple voltage. The FSP3603 is offered in a low profile (1mm) small 6-Pin SOT23 Package

■ ABSOLUTE MAXIMUM RATINGS(NOTE 1)

Parameter	Rating	Unit
V_{IN}	- 0.3 ~ +6	V
V_{OUT}	- 0.3 ~ +6	V
V_{SW}	- 0.3 ~ +6	A
FB SHDN Voltages	- 0.3 ~ +6	°C
Operating Temperature Range (Note 2)	- 40 ~ +85	°C
Lead Temperature (Soldering 10 sec.)	+ 300	°C
Thermal Resistance(Note 3)	250(θ_{JA})	°C/W
	110(θ_{JC})	
Storage Temperature Range	- 65 ~ +150	°C

Note 1: Absolute Maximum Ratings are those values beyond which the life of a device may be impaired.

Note 2: T_J is calculated from the ambient temperature T_A and power dissipation P_D according to the following formula:

$$T_J = T_A + (P_D) \times (250^\circ\text{C/W})$$

Note 3: Thermal Resistance is specified with approximately 1 square of 1 oz copper.

■ ELECTRICAL CHARACTERISTICS (NOTE 4)

(V_{IN} = 1.2V, V_{OUT} = 3.3V, T_A =25°C, Unless otherwise noted)

Parameter	Condition	Min.	Typ.	Max.	Unit
Output Voltage Range		2.5		5	V
Minimum Start-Up Voltage	$I_{LOAD} = 1\text{mA}$		0.85	1.0	V
Minimum Operating Voltage	$V_{SHDN} = V_{IN}$		0.5	0.65	V
Switching Frequency		0.95	1.2	1.5	
	- 40°C ~ +85°C	0.85	1.2	1.5	MHz
Max Duty Cycle	$V_{FB} = 1.15\text{V} - 40^\circ\text{C} \sim +85^\circ\text{C}$	80	85		%
Current Limit Delay to Output	Guaranteed by design		40		ns
Feedback Voltage	- 40°C ~ +85°C	1.192	1.230	1.268	V
NMOS Switch Leakage	$V_{SW} = 5\text{V}$		0.1	5	μA
PMOS Switch Leakage	$V_{SW} = 0\text{V}$		0.1	5	μA
NMOS Switch On Resistance	$V_{OUT} = 3.3\text{V}$		0.40		Ω
	$V_{OUT} = 5\text{V}$		0.35		
PMOS Switch On Resistance	$V_{OUT} = 3.3\text{V}$		0.70		Ω
	$V_{OUT} = 5\text{V}$		0.60		
NMOS Current Limit		600	850		mA
Quiescent Current (Active)	Measured on V_{OUT}		300	500	μA
Shutdown Current	$V_{SHDN} = 0\text{V}$		0.01	1	μA
Line Regulation	$V_{IN} = 0.8\text{V to } 3.0\text{V}, I_{OUT} = 10\text{mA}$		1		%/V
Load Regulation	$I_{OUT} = 1\text{mA to } 100\text{mA}$		0.02		%/mA
SHDN Input Threshold		0.35	0.60	1.50	V
SHDN Input Current	$V_{SHDN} = 5.5\text{V}$		0.01	1	μA

Note 4: 100% production test at +25°C. Specifications over the temperature range are guaranteed by design and characterization.

FUNCTIONAL BLOCK DIAGRAM

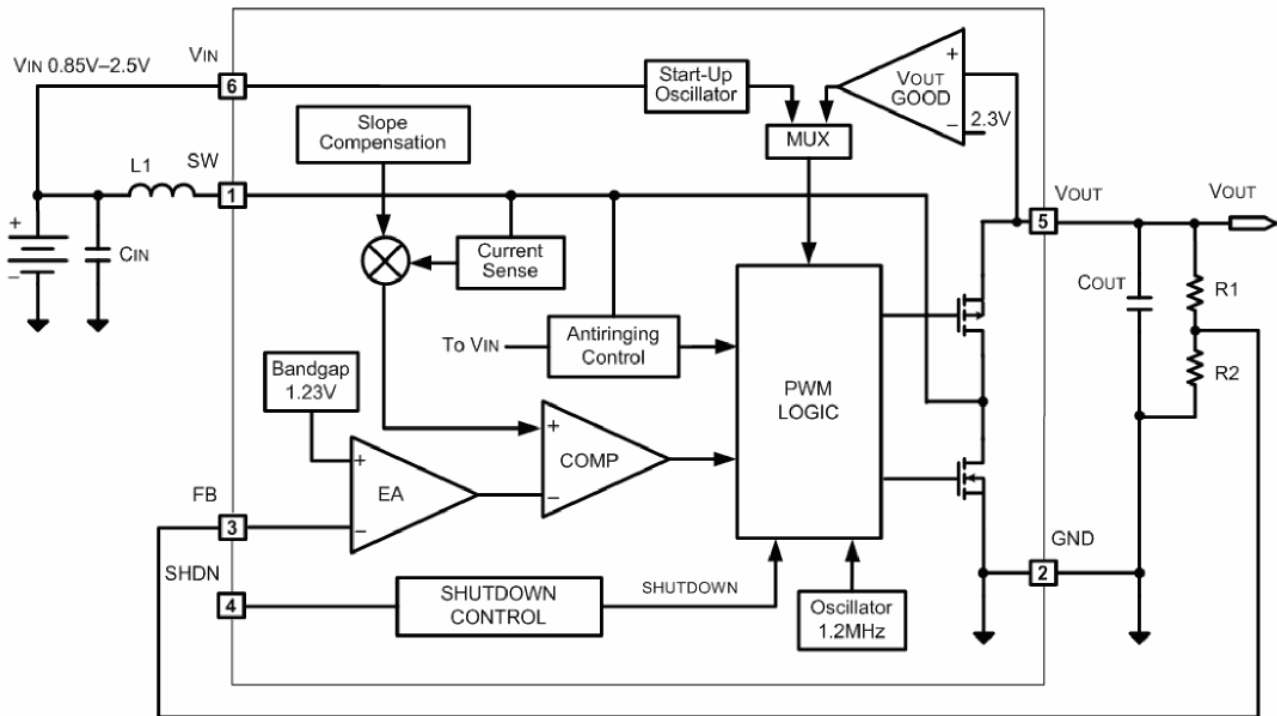

FUNCTION DESCRIPTION

Operation

The FSP3603 is a synchronous step-up DC-DC converter. It utilizes internal MOSFETs to achieve high efficiency over the full load current range. It operates at a fixed switching frequency of 1.2MHz, and uses the slope compensated current mode architecture. The device can operate with input voltage even below 1 V and the typical start-up voltage is 0.85V.

Synchronous Rectification

The FSP3603 integrates a synchronous rectifier to improve efficiency as well as to eliminate the external Schottky diode. The synchronous rectifier is used to reduce the conduction loss contributed by the forward voltage of Schottky diode. The synchronous rectifier is realized by a P-CH MOSFET with gate control circuitry that incorporates relatively complicated timing concerns.

Low Voltage Start-Up

The FSP3603 can start up at supply voltage down to 0.85V. During start-up, the internal low voltage start-up circuitry controls the NMOS switch to maximum peak inductor current. The device leaves the start-up mode once the V_{OUT} exceeds 2.3V. A Comparator (V_{OUT} GOOD Comp) monitors the output voltage and allows the chip into normal operation once the V_{OUT} exceeds 2.3V. The device is biased by V_{IN} during start-up while biased by V_{OUT} once V_{OUT} exceeds V_{IN} then the operation will be independent of V_{IN} .

Current Mode PWM Control

The FSP3603 is based on a slope compensated current mode control topology. It operates at a fixed frequency of 1.2MHz. At the beginning of each clock cycle, the main switch (NMOS) is turned on and the inductor current starts to ramp. After the maximum duty cycle or the sense current signal equals to the error amplifier(EA) output, the main switch is turned off and the synchronous switch (PMOS) is turn on. This control topology features cycle by cycle current limiting which can prevent the main switch from overstress and prevent external inductor from saturation.

Pulse Skipping Mode

At very light load, the FSP3603 automatically switches into Pulse Skipping Mode to improve efficiency. During this mode, the PWM control will skip some pulses to maintain regulation. If the load increases and the output voltage drops, the device will automatically switch back to normal PWM mode and maintain regulation.

Antiringing Control

An antiringing circuitry is included to remove the high frequency ringing that appears on the SW pin when the inductor current goes to zero. In this case, a ringing on the SW pin is induced due to remaining energy stored in parasitic components of switch and inductor. The antiringing circuitry clamps the voltage internally to battery voltage

and therefore dampens this ringing.

Device Shutdown

When SHDN is set logic high, the FSP3603 is put into operation. If SHDN is set logic low, the device is put into shutdown mode and consumes lower than 1 μA current. After start-up timing, the internal circuitry is supplied by V_{OUT} , however, if shutdown mode is enabled, the internal circuitry will be supplied by battery again.

TYPICAL CHARACTERISTICS

Efficiency vs. Output Current

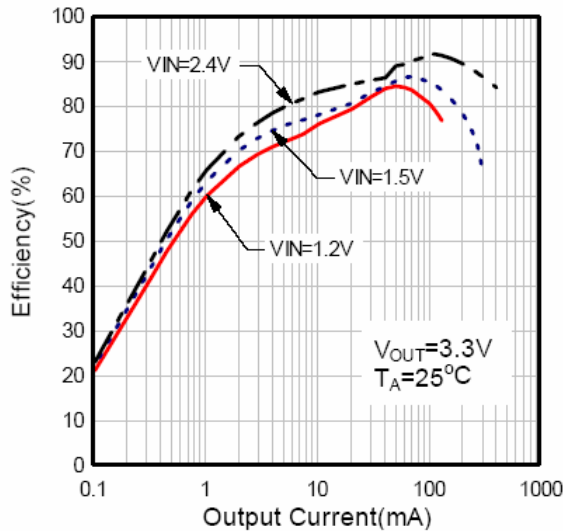

Efficiency vs. Output Current

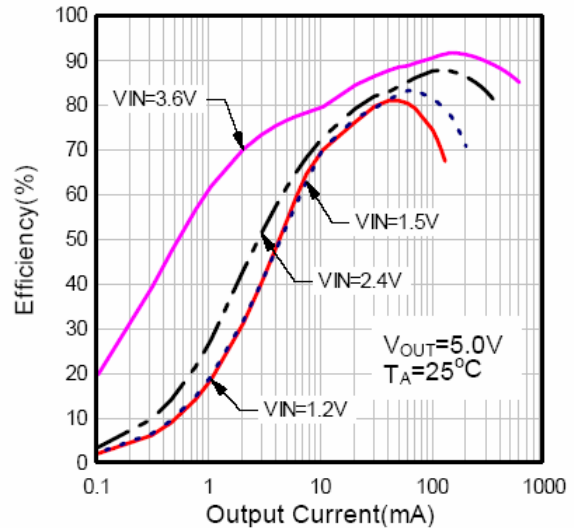

Output Voltage vs. Output Current

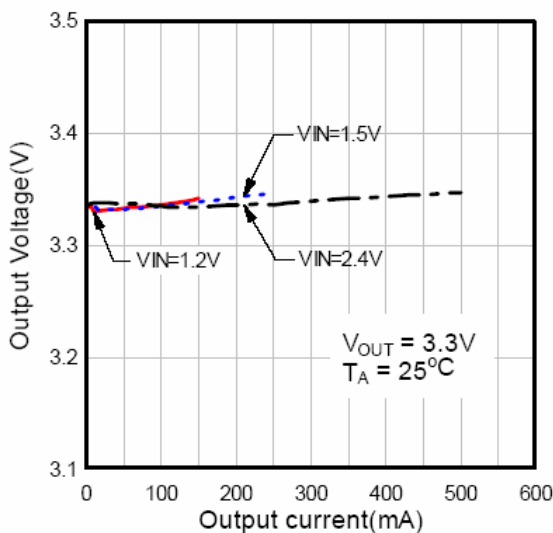

Output Voltage vs. Output Current

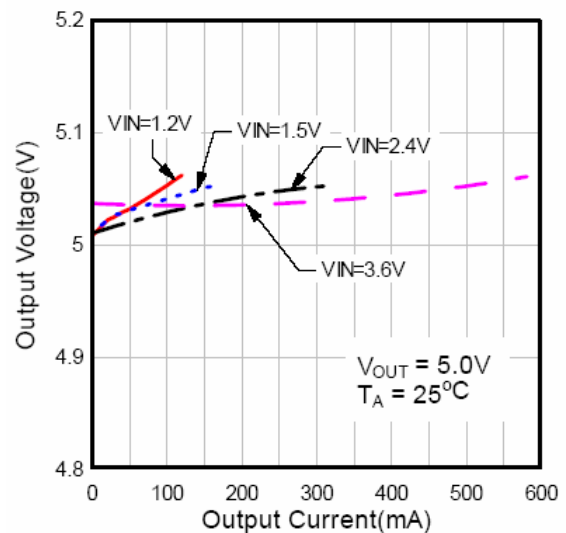

TYPICAL CHARACTERISTICS (CONTINUED)

Minimum Start-Up Voltage vs. Output Current

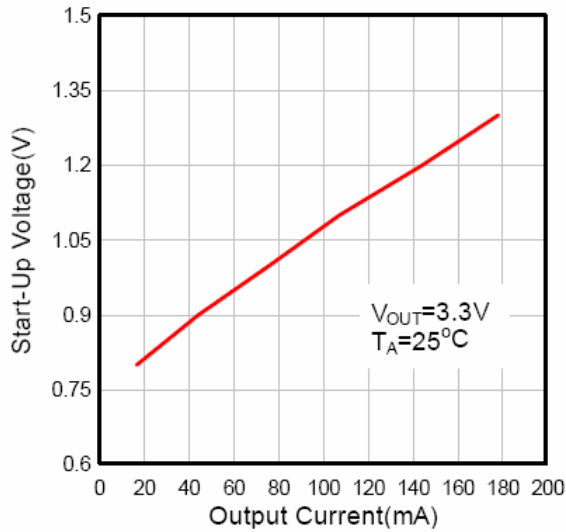

Maximum Output Current vs. Input Voltage

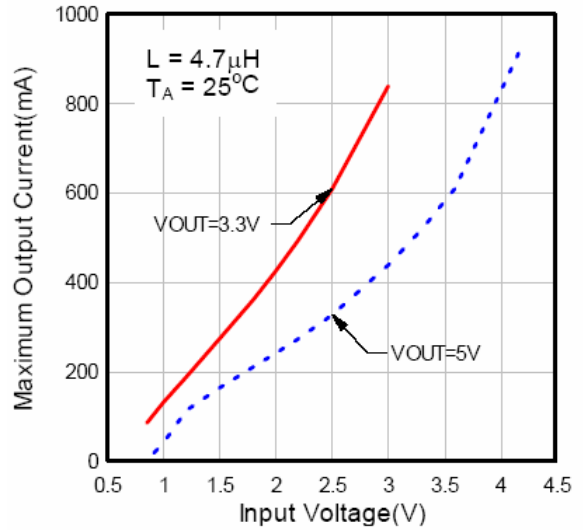

No Load Input Current vs. Input Voltage

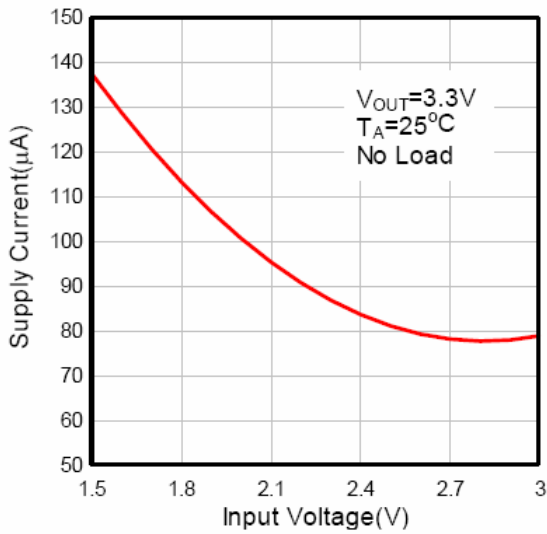

V_{OUT} vs. Temperature

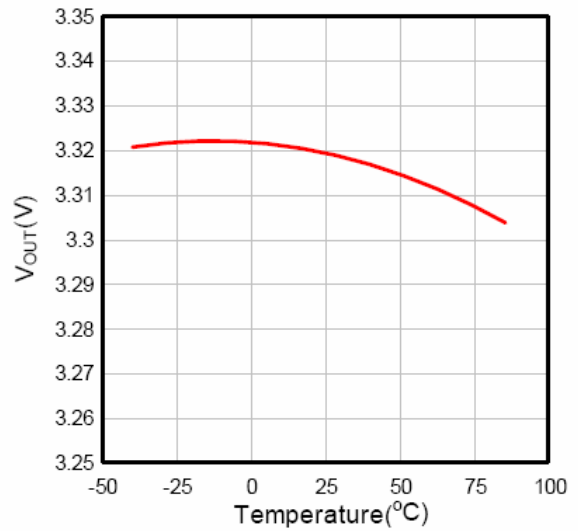

Pulse Skipping Mode Operation

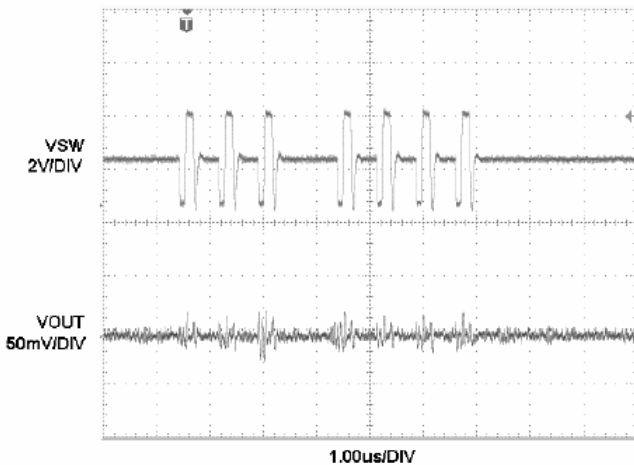

Antiringing Operation at SW

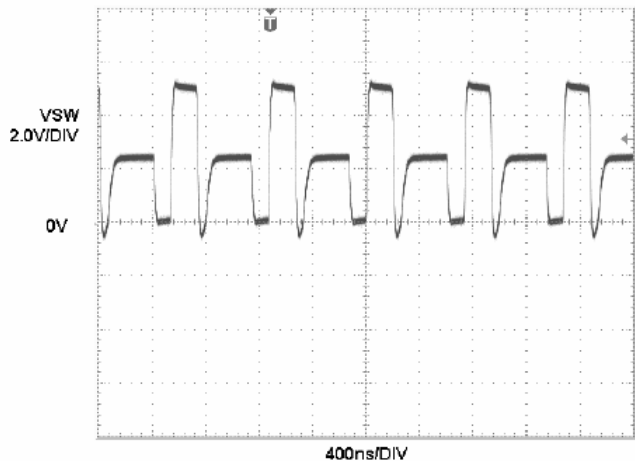

■ TYPICAL CHARACTERISTICS (CONTINUED)

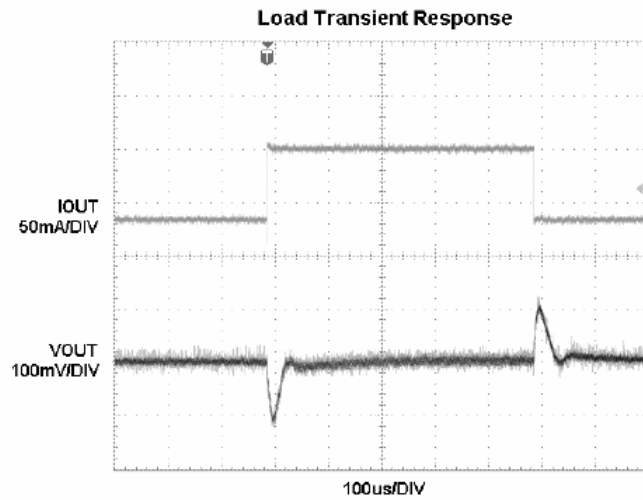

■ TYPICAL APPLICATION CIRCUIT

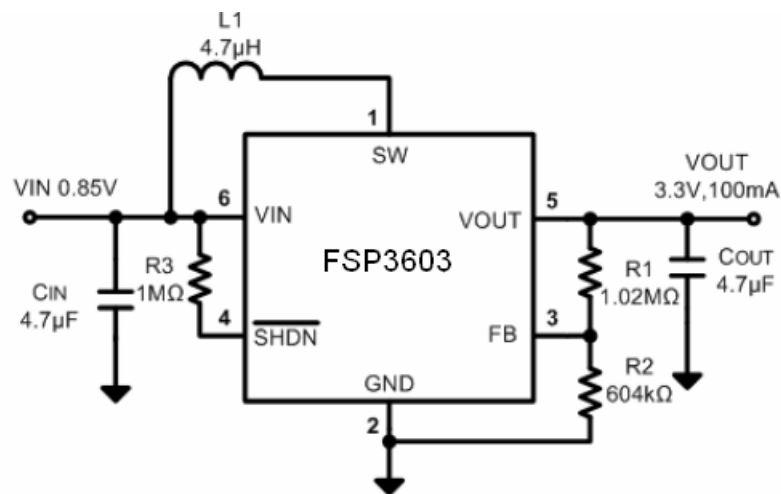

■ APPLICATION INFORMATION

Setting the Output Voltage

An external resistor divider is used to set the output voltage. The output voltage of the switching regulator (V_{OUT}) is determined by the following equation:

$$V_{OUT} = 1.23V \times \left(1 + \frac{R1}{R2} \right)$$

Table 1 list the resistor selection for output voltage setting.

V_{OUT}	R1(Ω)	R2(Ω)
3.3V	1.02M	604k
5.0V	1.02M	332k

Inductor Selection

The high switching frequency of 1.2MHz allows for small surface mount inductors. For most designs, the FSP3603 operates with inductors of 4.7μH to 10μH. The equation below can help to select the inductor, the

maximum output current can be get by this equation; where η is the efficiency, I_{PEAK} is the peak current limit, f is the switching frequency, L is the inductance value and D is the duty cycle.

$$I_{OUT} = \eta \times \left(I_{peak} - \frac{VIN \times D}{2 \times f \times L} \right) \times (1 - D)$$

Larger inductors mean less inductor current ripple and usually less output voltage ripple. Larger inductors also mean more load power can be delivered. But large inductors are also with large profile and costly. The inductor ripple current is typically set for 20% to 40% of the maximum inductor current. When selecting an inductor, the DC current rating must be high enough to avoid saturation at peak current. For optimum load transient and efficiency, the low DCR should be selected. Table 2 lists some typical surface mount inductors that meet target applications for the FSP3603:

Part Number	L (μH)	Max DCR (mΩ)	Rated D.C. Current (A)	Size WxLxH (mm)
Sumida CR43	4.7	108.7	1.15	4.3x4.8x3.5
	10	182	1.04	
Sumida CDRH4D 28	4.7	72	1.32	5.0x5.0x3.0
	5.6	101	1.17	
	6.8	109	1.12	
	10	128	1.00	
Toko D53LC	4.7	45	1.87	5.0x5.0x3.0
	6.8	68	1.51	
	10	90	1.33	

Output Capacitor Selection

The output capacitor is required to keep the output voltage ripple small and to ensure regulation loop stability. A 2.2μF to 10μF output capacitor is sufficient for most applications. If output capacitor is larger than 10μF, a phase lead capacitor must be included to maintain enough phase margin. The output capacitor must have low impedance at the switching frequency. Ceramic capacitors with X5R or X7R dielectrics are recommended due to their low ESR and high ripple current ratings.

Input Capacitor Selection

The input capacitor reduces the surge current drawn from the input and switching noise from the device. A minimum 4.7μF input capacitor is needed for most applications. The input capacitor impedance at the switching frequency should be less than input source impedance to prevent high frequency switching current passing to the input. A low ESR input capacitor sized for maximum RMS current must be used. Ceramic capacitors with X5R or X7R dielectrics are highly recommended because of their low ESR and small temperature coefficients.

Output Diode Selection

An Schottky diode should be included when the output voltage is above 4.5V. The Schottky diode is optional for the output voltage not more than 4.5V, but can improve efficiency by about 2% to 3%.

■ ORDERING INFORMATION

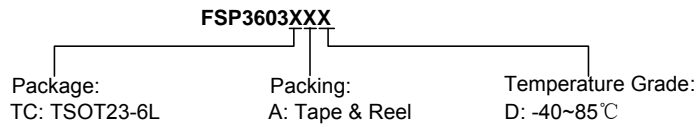

■ MARKING INFORMATION

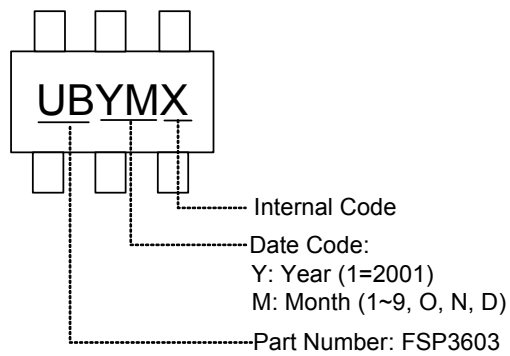

■ PACKAGE INFORMATION

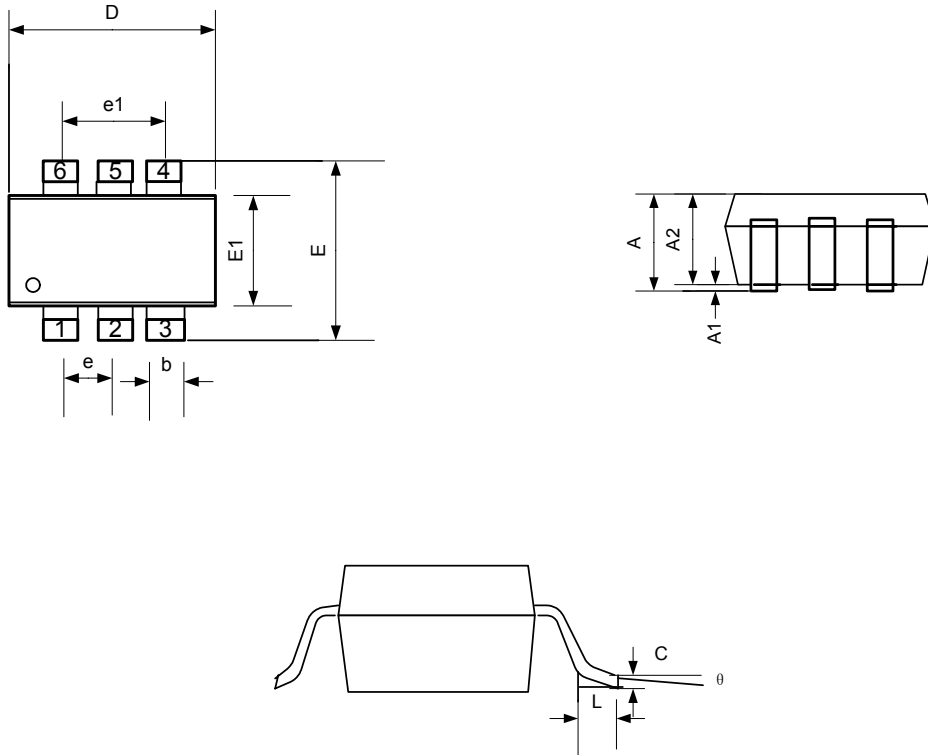

Symbol	Dimensions In Millimeters		Dimensions In Inches	
	Min.	Max.	Min.	Max.
A	0.900	1.100	0.036	0.044
A1	0.000	0.100	0.000	0.004
A2	0.900	1.000	0.036	0.040
b	0.300	0.500	0.012	0.020
C	0.100	0.200	0.004	0.008
D	2.800	3.100	0.112	0.124
E	2.50	3.100	0.100	0.124
E1	1.500	1.700	0.060	0.068
L	0.200	0.550	0.002	0.022
e	0.95 Bsc.		0.038 Bsc.	
e1	1.90 Bsc.		0.076 Bsc.	
θ	0°	10°	0°	10°