

SMD Power Inductor CDRH6D38/T125



Halogen Free



Description

- Ferrite drum core construction.
- Magnetically shielded.
- L × W × H: 7.0 × 7.0 × 4.0 mm Max.
- Product weight: 0.6g (Ref.)
- Moisture Sensitivity Level: 1
- RoHS compliance.
- Halogen Free available.
- Qualification to AEC-Q200.

Environmental Data

- Operating temperature range: -40°C ~ +125°C (including coil's self temperature rise)
- Storage temperature range: -40°C ~ +125°C
- Solder reflow temperature: 260 °C peak.

Packaging

- Carrier tape and reel packaging
- 13.0" diameter reel
- 1000 pcs per reel

Applications

- Automotive and other high temperature, high reliability application.

Dimension - [mm]

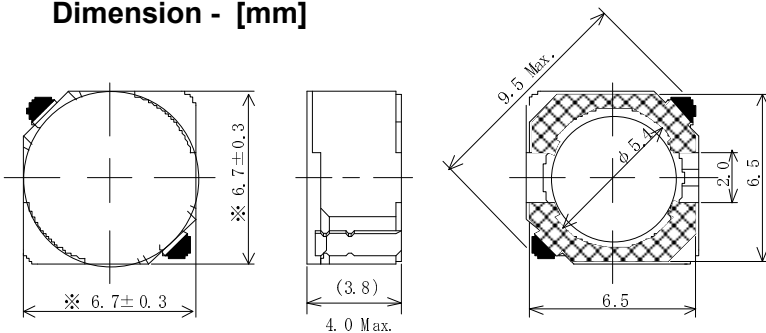

Land pattern and Schematics - [mm]

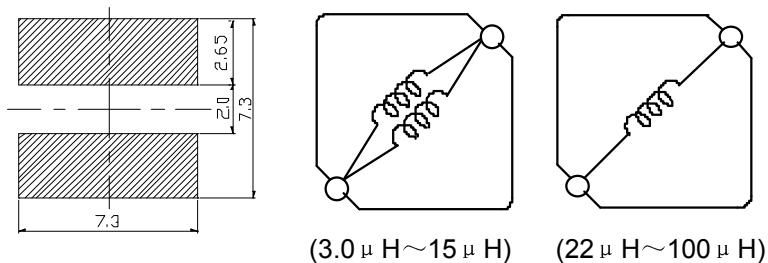

SMD Power Inductor CDRH6D38/T125



Electrical Characteristics

Part Name	Stamp	Inductance (μ H) 100kHz	D.C.R.(m Ω) [Max.] (at 20°C)	Saturation Current (A) ※1		Temperature Rise Current (A) ※2
				(at20°C)	(at125°C) (Typ.)	
CDRH6D38T125NP-3R0NC	3R0	3.0 \pm 30%	22.0(17.5)	3.90	3.00	4.50
CDRH6D38T125NP-3R9NC	3R9	3.9 \pm 30%	24.5(19.6)	3.30	2.50	4.00
CDRH6D38T125NP-4R7NC	4R7	4.7 \pm 30%	27.5(22.0)	3.10	2.40	3.80
CDRH6D38T125NP-5R6NC	5R6	5.6 \pm 30%	30.5(24.4)	2.85	2.10	3.50
CDRH6D38T125NP-6R8NC	6R8	6.8 \pm 30%	33.0(26.4)	2.65	2.00	3.30
CDRH6D38T125NP-10 \emptyset PC	100	10 \pm 25%	43.5(34.8)	2.20	1.70	3.00
CDRH6D38T125NP-15 \emptyset PC	150	15 \pm 25%	59.8(47.8)	1.80	1.50	2.20
CDRH6D38T125NP-22 \emptyset PC	220	22 \pm 25%	103.4(82.7)	1.50	1.00	1.65
CDRH6D38T125NP-33 \emptyset PC	330	33 \pm 25%	145(116)	1.25	0.95	1.45
CDRH6D38T125NP-47 \emptyset PC	470	47 \pm 25%	181(145)	1.00	0.80	1.20
CDRH6D38T125NP-68 \emptyset PC	680	68 \pm 25%	250(200)	0.85	0.65	1.00
CDRH6D38T125NP-101PC	101	100 \pm 25%	372(298)	0.68	0.55	0.85

※1. Saturation current: The value of D.C. current when the inductance decreases to 65% of its nominal value.

※2. Temperature rise current: The value of D.C. current when the temperature rise is $\Delta t=40^{\circ}\text{C}$ ($T_a=20^{\circ}\text{C}$).

SMD Power Inductor CDRH6D38/T125



Saturation Current & Temperature Rise Graph

— L (20°C) — L (125°C) — ΔT

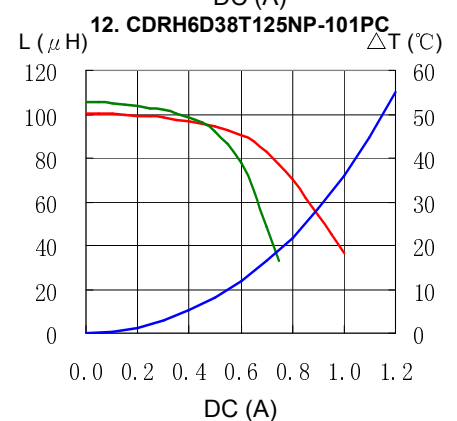
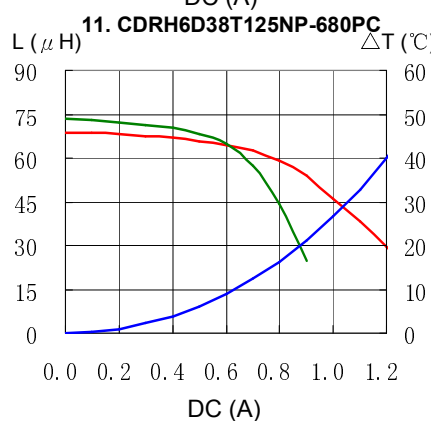
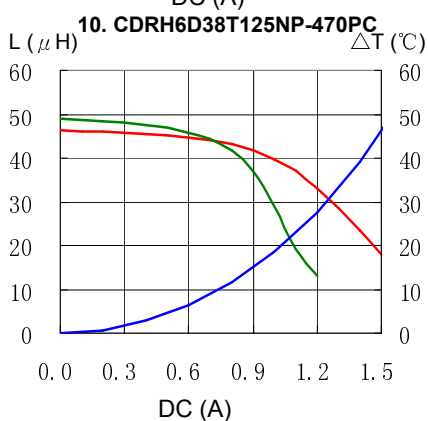
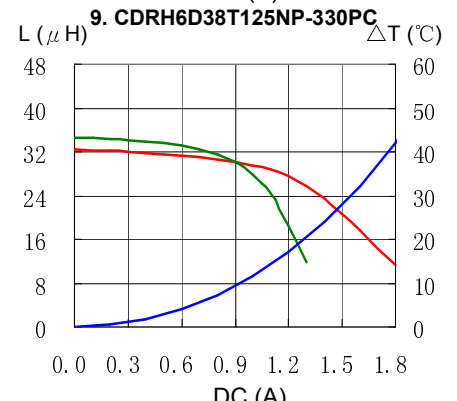
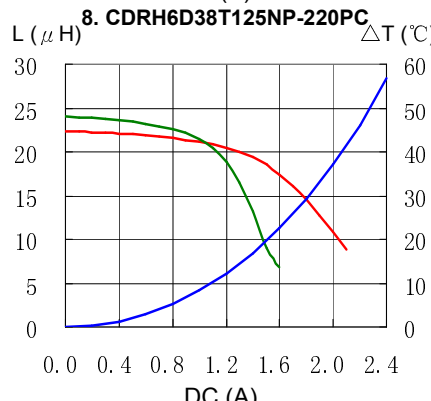
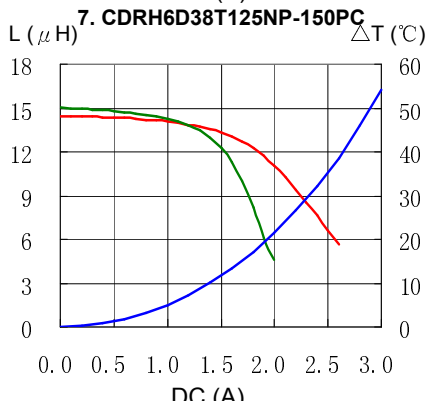
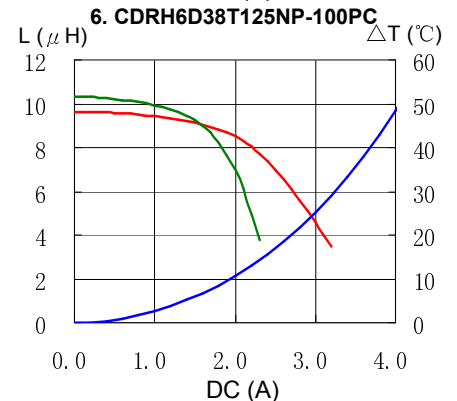
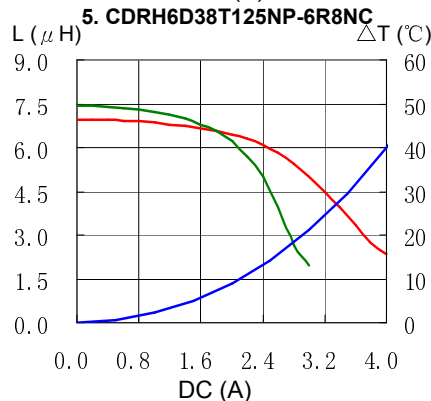
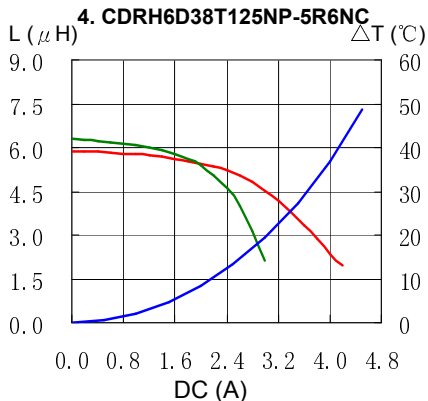
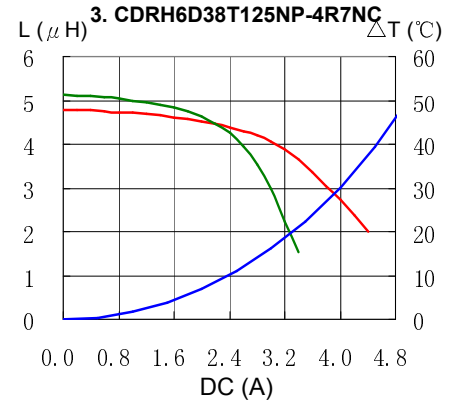
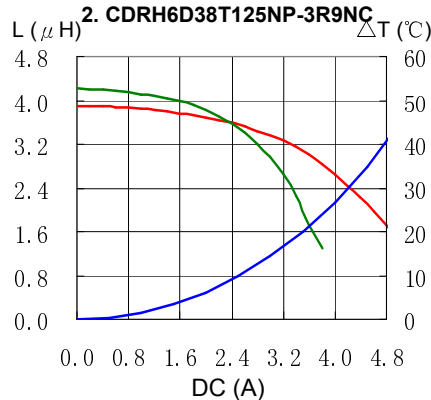
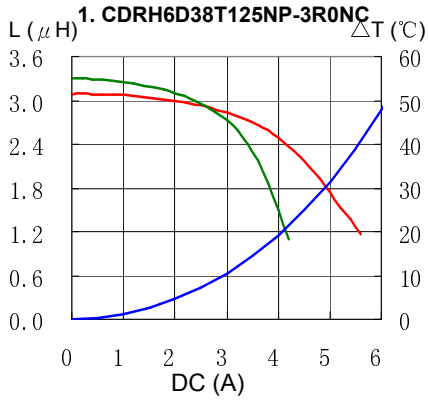

SMD Power Inductor CDRH6D38/T125



Solder Reflow Condition

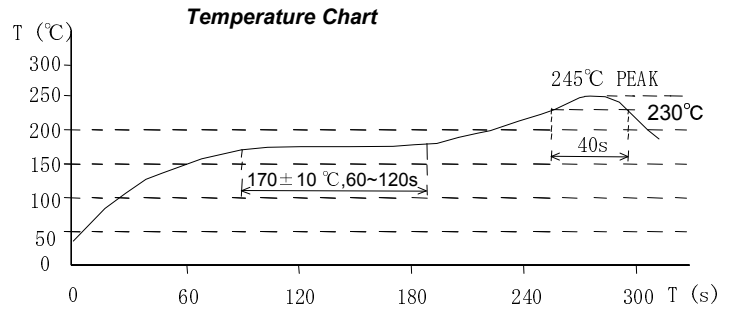

Please refer to the sales offices on our website - <http://www.sumida.com>

Hong Kong

Tel.+852-2880-6781
FAX.+852-2565-9600
sales@hk.sumida.com

Saitama(Japan)

Tel.+81-48-691-7300
FAX.+81-48-691-7340
sales@jp.sumida.com

Chicago

Tel.+1-847-545-6700
FAX. +1-847-545-6720
sales@us.sumida.com

Shanghai

Tel.+86-21-5836-3299
FAX.+86-21-5836-3266
shanghai.sales@cn.sumida.com

Seoul

Tel.+82-2-6237-0777
FAX.+82-2-6237-0778
sales@kr.sumida.com

Oberzell

Tel.+49-8591-937-0
FAX. +49-8591-937-103
contact@eu.sumida.com

Shenzhen

Tel.+86-755-8291-0228
FAX.+86-755-8291-0338
shenzhen.sales@cn.sumida.com

Singapore

Tel.+65-6296-3388
FAX.+65-6841-4426
sales@sg.sumida.com

Neumarkt

Tel.+49-9181-4509-110
FAX. +49-9181-4509-310
infocomp@eu.sumida.com

Taipei

Tel.+886-2-8751-2737
FAX.+886-2-8751-2738
sales@tw.sumida.com

San Jose

Tel.+1-408-321-9660
FAX.+1-408-321-9308
sales@us.sumida.com