









Frame size		9A	12A	18A	22A				
3-pole Contactors		 <p>includes AU-1 auxiliary switch, (1 N.O. / 1 N.C.)</p>							
Types	AC coil DC coil					GMC-9 GMD-9	GMC-12 GMD-12	GMC-18 GMD-18	GMC-22 GMD-22
Ratings / IEC60947-4		kW	A	kW	A	kW	A	kW	A
AC1		25		25		40		40	
AC3	200/240V	2.5	11	3.5	13	4.5	18	5.5	22
	380/440V	4	9	5.5	12	7.5	18	11	22
	500/550V	4	7	7.5	12	7.5	13	15	22
	690V	4	5	7.5	9	7.5	9	15	18
Ratings / UL508		hp	A	hp	A	hp	A	hp	A
continuous current		20		25		30		32	
single phase	115V	0.5		0.5		1		2	
	230V	1		2		3		3	
three phase	200V	2		3		5		7	
	230V	2		3		5		7.5	
	460V	5		7.5		10		10	
	575V	7.5		10		15		15	
NEMA size		00		00		0		0	



4-pole Contactors									
Types	AC coil DC coil					GMC-9/4 GMD-9/4	GMC-12/4 GMD-12/4	GMC-18/4 GMD-18/4	GMC-22/4 GMD-22/4
AC1(A)		20		20		25		32	



Available coil voltages	AC: 24, 42, 48, 110, 120, 208, 220, 240, 277, 380, 440, 480, 600V DC: 12, 20, 24, 48, 60, 80, 100, 110, 125, 200, 220, 250V <i>Ordering Example: GMC-9-AC120V (see also page 6)</i>
--------------------------------	---

Additional Auxiliary Contacts		 AU-2 2-pole Front mount		 AU-4 4-pole Front mount		 AU-1 2-pole Side mount	
Configuration	Part No.	Configuration	Part No.	Configuration	Part No.	Configuration	Part No.
2 N.O.	AU-2-20	4 N.O.	AU-4-40	1 N.O. / 1 N.C.	AU-1		
2 N.C.	AU-2-02	3 N.O. / 1 N.C.	AU-4-31				
1 N.O. / 1 N.C.	AU-2-11	2 N.O. / 2 N.C.	AU-4-22				
		1 N.O. / 3 N.C.	AU-4-13				
		4 N.C.	AU-4-04				



Overload Relays		 GT-22		Setting ranges (A) <table border="0"> <tr><td>0.1 - 0.16</td><td>4 - 6</td></tr> <tr><td>0.16 - 0.25</td><td>5 - 8</td></tr> <tr><td>0.25 - 0.4</td><td>6 - 9</td></tr> <tr><td>0.4 - 0.63</td><td>7 - 10</td></tr> <tr><td>0.63 - 1</td><td>9 - 13</td></tr> <tr><td>1 - 1.6</td><td>12 - 16</td></tr> <tr><td>1.6 - 2.5</td><td>16 - 22</td></tr> <tr><td>2.5 - 4</td><td></td></tr> </table>	0.1 - 0.16	4 - 6	0.16 - 0.25	5 - 8	0.25 - 0.4	6 - 9	0.4 - 0.63	7 - 10	0.63 - 1	9 - 13	1 - 1.6	12 - 16	1.6 - 2.5	16 - 22	2.5 - 4		 AZ-22H Base for separate mounting
0.1 - 0.16	4 - 6																				
0.16 - 0.25	5 - 8																				
0.25 - 0.4	6 - 9																				
0.4 - 0.63	7 - 10																				
0.63 - 1	9 - 13																				
1 - 1.6	12 - 16																				
1.6 - 2.5	16 - 22																				
2.5 - 4																					
Class 10A	Differential	GTK-22																			
	Non-differential (3-heater)	GTH-22/3																			
	Non-differential (2-heater)	GTH-22																			
Class 20	Differential	GTK-22/L																			





Contactors (9 to 85A)



32A		40A		50A		65A		75A		85A	
		<i>includes 2 AU-1 auxiliary switches, (2 N.O. / 2 N.C.)</i>						<i>includes 2 AU-1 auxiliary switches, (2 N.O. / 2 N.C.)</i>			
GMC-32		GMC-40		GMC-50		GMC-65		GMC-75		GMC-85	
GMD-32		GMD-40		GMD-50		GMD-65		GMD-75		GMD-85	
kW	A	kW	A	kW	A	kW	A	kW	A	kW	A
	50		60		80		100		110		135
7.5	32	11	40	15	55	18.5	65	22	75	25	85
15	32	18.5	40	22	50	30	65	37	75	45	85
18.5	28	22	32	30	43	33	60	37	64	45	75
18.5	20	22	23	30	28	33	35	37	42	45	45
hp	A	hp	A	hp	A	hp	A	hp	A	hp	A
	45		50		70		80		90		100
2		3		3		5		5		7.5	
5		5		7.5		10		15		15	
7.5		10		10		15		20		25	
10		10		15		20		25		30	
20		25		30		40		50		50	
20		25		30		40		50		50	
1		1		2		2		2		3	

											
GMC-32/4		GMC-40/4		GMC-50/4		GMC-65/4		GMC-75/4		GMC-85/4	
GMD-32/4		GMD-40/4		GMD-50/4		GMD-65/4		GMD-75/4		GMD-85/4	
50		60		80		100		110		135	

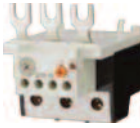
AC: 24, 48, 110, 120, 208, 220, 240, 277, 380, 440, 480, 600V
 DC: 12, 20, 24, 48, 60, 80, 100, 110, 125, 200, 220, 250V
Ordering Example: GMC-32-AC120V (see also page 6)

 AU-2 2-pole Front mount		 AU-4 4-pole Front mount		 AU-1 2-pole Side mount	
Configuration	Part No.	Configuration	Part No.	Configuration	Part No.
2 N.O.	AU-2-20	4 N.O.	AU-4-40	1 N.O. / 1 N.C.	AU-1
2 N.C.	AU-2-02	3 N.O. / 1 N.C.	AU-4-31		
1 N.O. / 1 N.C.	AU-2-11	2 N.O. / 2 N.C.	AU-4-22		
		1 N.O. / 3 N.C.	AU-4-13		
		4 N.C.	AU-4-04		

 GT-40 Setting ranges (A) 4 - 6 12 - 18 5 - 8 16 - 22 6 - 9 18 - 26 7 - 10 24 - 36 9 - 13 28 - 40		 AZ-40H Base for separate mounting		 GT-85 Setting ranges (A) 7 - 10 28 - 40 9 - 13 34 - 50 12 - 18 45 - 65 16 - 22 54 - 75 18 - 26 63 - 85 24 - 36		 AZ-85H Base for separate mounting	
GTK-40				GTK-85			
GTH-40/3				GTH-85/3			
GTH-40				GTH-85			
GTK-40/L				GTK-85/L			

Frame size		100A		125A		150A	
3-pole Contactors <i>For further technical information see pages 10-11.</i>				<i>includes 2 AU-100 auxiliary switches, (2 N.O. / 2 N.C.)</i>			
		<i>includes 2 AU-100 auxiliary switches, (2 N.O. / 2 N.C.)</i>					
Types	AC/DC common coil	GMC-100		GMC-125		GMC-150	
Ratings / IEC60947-4		kW	A	kW	A	kW	A
AC1		150		150		200	
AC3		200/240V	30	105	37	125	45
		380/440V	55	105	60	120	75
		500/550V	55	85	60	90	140
		690V	55	65	60	70	100
Ratings / UL508		hp	A	hp	A	hp	A
continuous current		160		160		210	
single phase		115V	7.5	10	15	25	
		230V	15	20	25	40	
three phase		200V	30	40	40	50	
		230V	30	40	40	50	
		460V	60	75	100	100	
		575V	60	75	75	100	
NEMA size		3		3		4	

4-pole Contactors <i>For further technical information visit altechcorp.com.</i>				
Types	AC/DC common coil	GMC-100/4	GMC-125/4	GMC-150/4
AC1(A)		150	155	200
Available nominal coil voltages (AC 50/60Hz); (DC)		AC: 24 (24-25), 48 (48-50), 100/200 (100-240), 300 (265-347), 400 (380-450), 500V (440-575) DC: 24, 48, 100/200V (100-220) <i>Ordering Example: GMC-100-AC100/200V (see also page 6)</i>		

Additional Auxiliary Contacts		AU-100 1NO+1NC, Side mount
--------------------------------------	---	--------------------------------------

Overload Relays

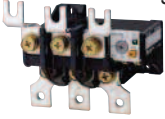
Bimetallic style Type GT		Setting ranges (A)	Setting ranges (A)
			
		34 - 50 39 - 57 43 - 65 54 - 80 65 - 100 85 - 125	34 - 50 39 - 57 43 - 65 54 - 80 65 - 100 85 - 125 100 - 150
		GT- 100	GT- 150
Class 10A	Differential	GTK-100	GTK-150
	Non-differential (3-heater)	GTH-100/3	GTH-150/3
	Non-differential (2-heater)	GTH-100	GTH-150
Class 20	Differential	GTK-100/L	GTK-150/L

Contactors (100 to 800A)

180A		220A		300A		400A		600A		800A	
		<i>includes 2 AU-100 auxiliary switches, (2 N.O. / 2 N.C.)</i>				<i>includes 2 AU-100 auxiliary switches, (2 N.O. / 2 N.C.)</i>				<i>includes 2 AU-100 auxiliary switches, (2 N.O. / 2 N.C.)</i>	
GMC-180		GMC-220		GMC-300		GMC-400		GMC-600		GMC-800	
kW	A	kW	A	kW	A	kW	A	kW	A	kW	A
230		260		350		420		660		900	
55	180	75	250	90	300	125	400	190	630	220	800
90	180	132	250	160	300	220	400	330	630	440	800
110	180	132	200	160	250	225	350	330	500	550	720
110	120	132	150	200	220	250	300	330	420	500	630
hp	A	hp	A	hp	A	hp	A	hp	A	hp	A
230		275		350		450		660		900	
15		15									
30		40									
60		60		100		125		150		250	
60		75		100		150		200		300	
125		150		200		300		400		600	
125		150		200		300		400		600	
4		4		5		5		6		7	
											
GMC-180/4		GMC-220/4		GMC-300/4		GMC-400/4		GMC-600/4		GMC-800/4	
230		260		350		420		660		800	
AC: 100/200 (100-240), 300 (265-347), 400 (380-450), 500V (440-575) DC: 100/200V (100-220) <i>Ordering Example: GMC-180-AC100/200V (see also page 6)</i>								AC: 100 (100-127), 200 (200-240), 300 (265-347), 400 (380-450), 500V (440-575) DC: 100 (100-110), 200V (200-220)			
											
				AU-100		<i>1NO+1NC, Side mount</i>					
		Setting ranges (A) 65 - 100 85 - 125 100 - 150 120 - 180 160 - 240				Setting ranges (A) 85 - 125 100 - 150 120 - 180 160 - 240 220 - 300 260 - 400				Setting ranges (A) 220 - 300 260 - 400 400 - 600 520 - 800	
GT- 220				GT- 400				GT- 800			
GTK-220				GTK-400				GTK-600			
GTH-220/3				GTH-400/3				GTH-600/3			
GTH-220				GTH-400				GTH-600			
GTK-220/L				GTK-400/L				GTK-600/L			

3NO main contacts
1 auxiliary contact*

For further technical
information see page 13.

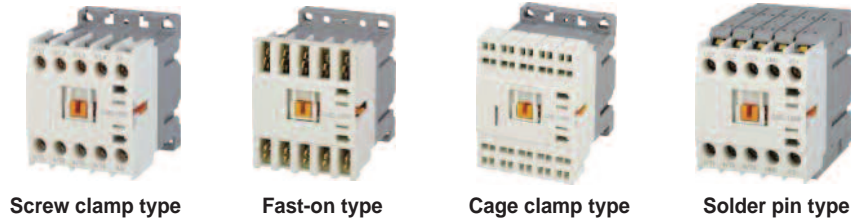

Frame size		6A	9A	12A	16A
STANDARD	Screw clamp type	AC coil GMC-6M	GMC-9M	GMC-12M	GMC-16M
		DC coil GMD-6M	GMD-9M	GMD-12M	GMD-16M
OPTIONAL	Fast-on type	AC coil GMC-6MF	GMC-9MF	GMC-12MF	GMC-16MF
		DC coil GMD-6MF	GMD-9MF	GMD-12MF	GMD-16MF
Cage clamp type	AC coil	GMC-6MC	GMC-9MC	GMC-12MC	GMC-16MC
	DC coil	GMD-6MC	GMD-9MC	GMD-12MC	GMD-16MC
Solder pin type	AC coil	GMC-6MP	GMC-9MP	GMC-12MP	GMC-16MP
	DC coil	GMD-6MP	GMD-9MP	GMD-12MP	GMD-16MP

Ratings / IEC60947-4		kW	A	kW	A	kW	A	kW	A
AC1			20		20		20		20
AC3	200/240V	1.5	7	2.2	9	3	12	4	15
	380/440V	2.2	6	4	9	5.5	12	7.5	16
	500/550V	3	5	3.7	6	4	7	5.5	9
	690V	3	4	4	5	4	5	4	5
Ratings / UL508		hp	A	hp	A	hp	A	hp	A
continuous current			20		25		30		32
single phase	115V	0.5		0.5		1		2	
	230V	1		2		3		3	
three phase	200V	2		3		5		7	
	230V	2		3		5		7.5	
	460V	5		7.5		10		10	
	575V	7.5		10		15		15	
NEMA size		00		00		00		0	

Available coil voltages
 AC 50/60Hz: 24, 36, 42, 48, 110, 115, 120, 127, 200/208, 220, 220/230, 230/240, 256, 277, 380/400, 400, 440, 480, 500, 550, 600V (60Hz)
 DC: 12, 20, 24, 36, 42, 48, 60, 72, 110, 120, 125, 220, 240, 250V
Ordering Example: GMC-6M-10-AC120V (see also page 6)

Additional Auxiliary Contacts

	Screw clamp type	Fast-on type	Cage clamp type	Solder pin type
2-pole, Front mount	AU-2M	AU-2MF	AU-2MC	
4-pole, Front mount	AU-4M	AU-4MF	AU-4MC	
2-pole, Side mount	AU-1M	AU-1MF	AU-1MC	

Overload Relays

Bimetallic style Type GT Class 10A	 GT-12M	Setting ranges (A) 0.1 - 0.16 0.16 - 0.25 0.25 - 0.4 0.4 - 0.63 0.63 - 1 1 - 1.6 1.6 - 2.5 2.5 - 4	4 - 6 5 - 8 6 - 9 7 - 10 9 - 13 12 - 16	 AZ-12H <i>Base for separate mounting</i>
	Differential	GTK-12M		
	Non-differential (3-heater)	GTH-12M/3		
	Non-differential (2-heater)	GTH-12M		

* See page 6 for how to specify the type of auxiliary switch (N.O. or N.C.).

Contactors Numbering System

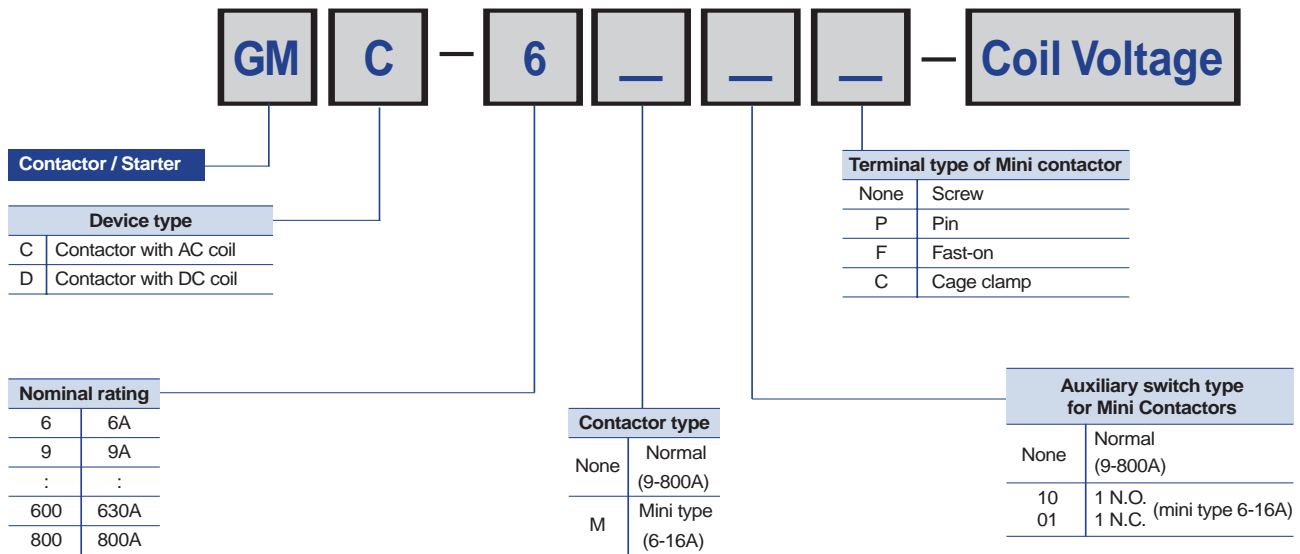

Thermal Overload Relay

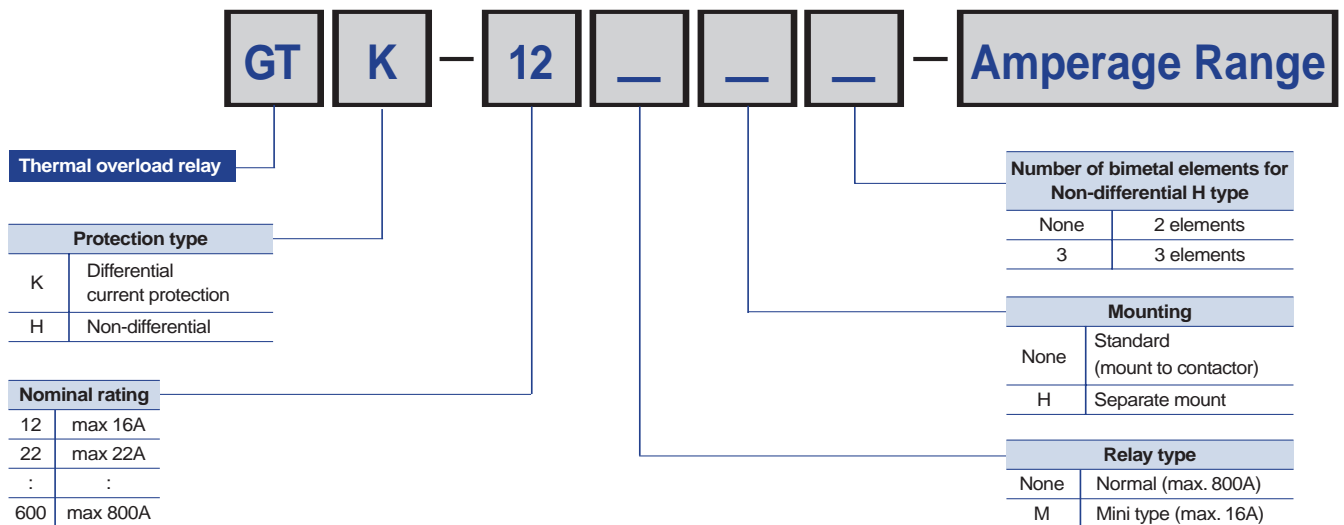

Other devices / accessories are available.
Consult Altech Corp.[®] for more information.

2-pole AC Contactors, Definite Purpose

For further technical information see page 14.

Description

- Two normally open main contacts
- Screw clamp or fast-on connections
- Small and light design suitable for use in air conditioners, heaters, refrigerators, etc.
- Screw mountable
- N.O. auxiliary contact
- AC control voltage



Selection

Type	AC3 ratings			AC4 ratings			AC1 I _{th}	Making current	Breaking current
	220~ 240V	380~ 440V	500~ 550V	220~ 240V	380~ 440V	500~ 550V			
SMC-20P2	20A	17A	14A	18A	13A	10A	30A	120A	20A
SMC-25P2	25A	21A	17A	20A	14A	12A	35A	150A	25A
SMC-30P2	30A	23A	21A	22A	20A	14A	40A	180A	30A

Connection style

Terminal code	Main terminal	Coil terminal	Remarks
TSBS	Screw clamp	Screw clamp	
TSBQ		Fast-on	
TQBS	Fast-on(Quick connect)	Screw clamp	not available for SMC-30P2
TQBQ		Fast-on(Quick connect)	

Endurance

Mechanical lifetime		2 mil. Operations
Electrical lifetime	at AC3	0.2 mil. Operations (1200 operations/h)
	at AC4	0.015 mil. Operations (600 operations/h)

Contactor coil voltage, AC 50/60Hz

24, 48-50, 110/110-120, 208-220/208-240V

Ordering information

Specify type, terminal code and coil voltage

Example : SMC-25P2, TSBQ, AC110V 50Hz



3-pole Contactors / AC Coil

(Dimensions shown in mm, to convert to inches multiply by 0.03937)

- GMC-9
- GMC-12
- GMC-18
- GMC-22

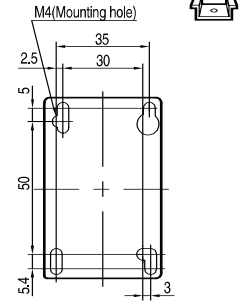
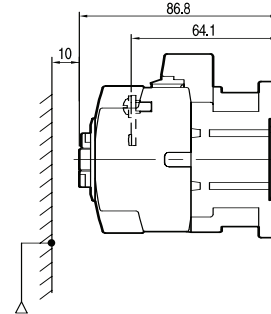
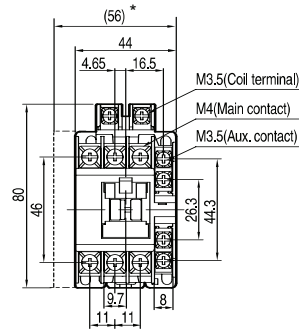

*Optional auxiliary contact unit (side mount type)

Weight: GMC-9 & 12: 0.33kg (0.73 lbs.)
GMC-18 & 22: 0.37kg (0.82 lbs.)

- GMC-32
- GMC-40

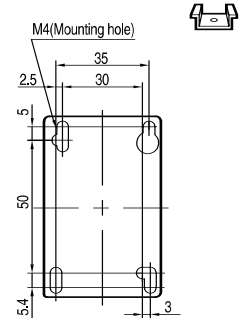
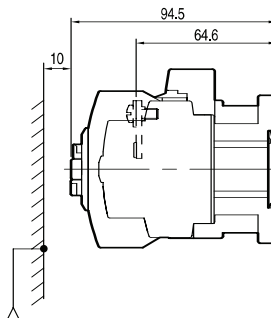
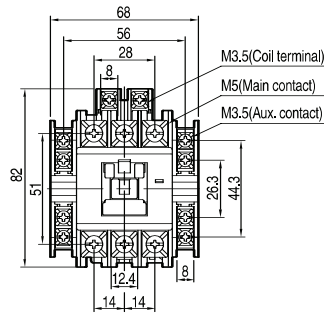

Weight GMC-32 & 40: 0.45kg (0.99 lbs.)

- GMC-50
- GMC-65
- GMC-75
- GMC-85

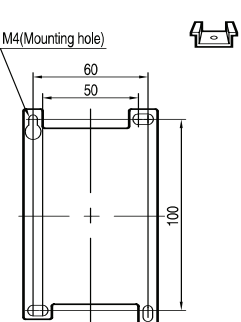
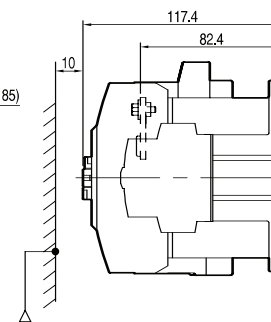
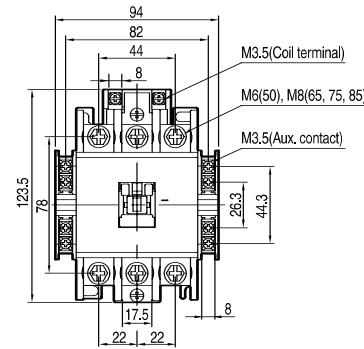

Weight: GMC-50 to 85: 1kg (2.21 lbs.)

GMC-9~22

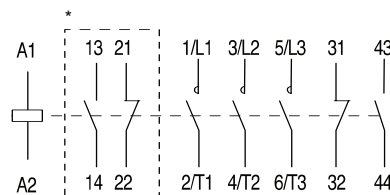

GMC-32~85

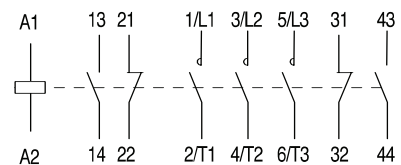

*Optional auxiliary contact unit

3-pole Contactors / DC Coil

(Dimensions shown in mm, to convert to inches multiply by 0.03937)

- GMD-9
- GMD-12
- GMD-18
- GMD-22

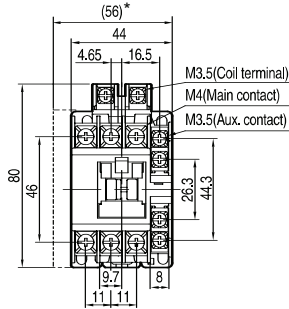

*Optional auxiliary contact unit (side mount type)

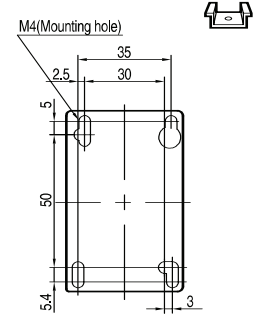
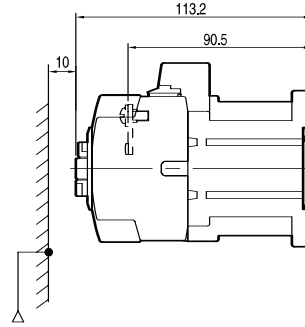

Weight: GMD-9 & 12: 0.55kg (1.21 lbs.)
GMD-18 & 22: 0.59kg (1.30 lbs.)

- GMD-32
- GMD-40

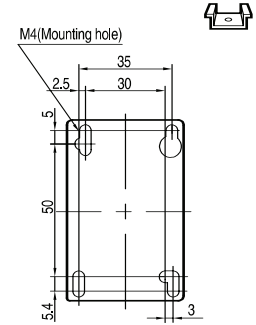
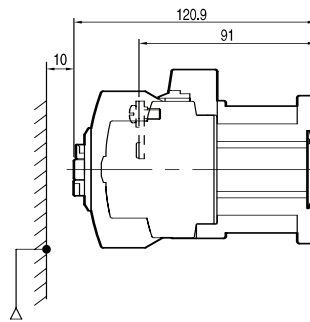
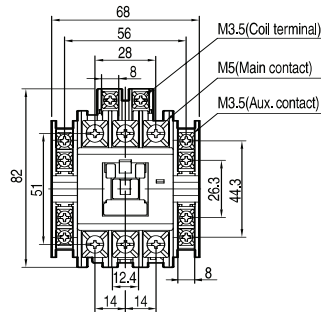

Weight: GMD-32 & 40: 0.67kg (1.48 lbs.)

- GMD-50
- GMD-65
- GMD-75
- GMD-85

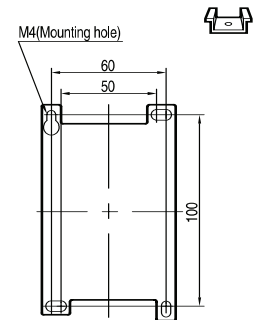
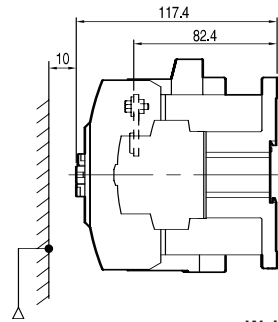
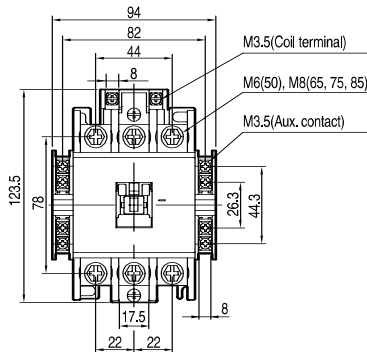

Weight: GMD-50, 65, 75 & 85: 1.06kg (2.34 lbs.)

GMD-9~22

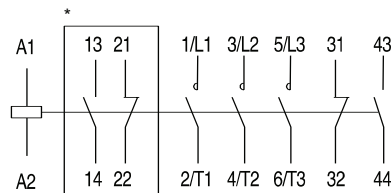

*Optional auxiliary contact unit

GMD-32, 40

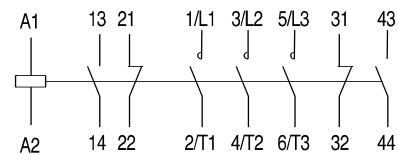

GMD-50~85

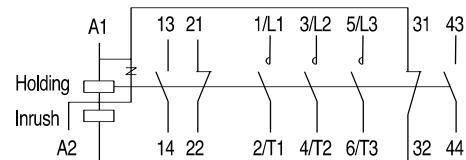

3-pole Contactors

(Dimensions shown in mm, to convert to inches multiply by 0.03937)

GMC-100
GMC-125

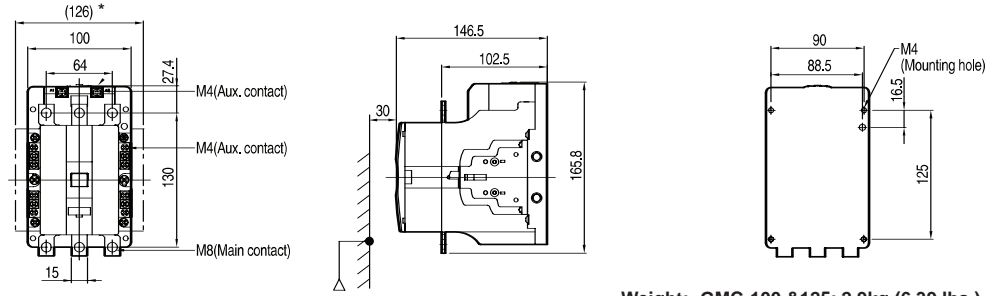

Weight: GMC-100 & 125: 2.9kg (6.39 lbs.)

GMC-150

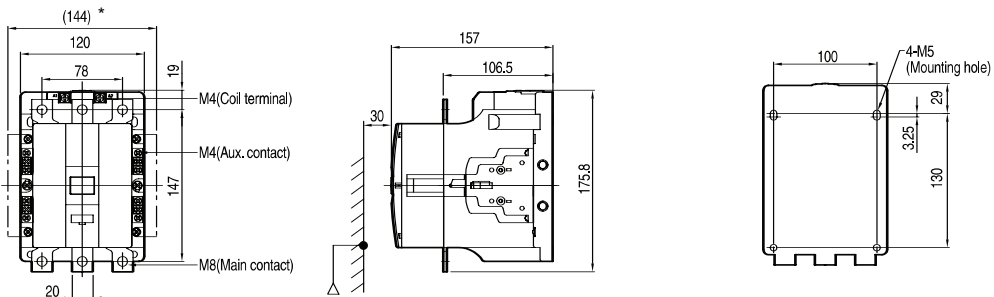

Weight: GMC-150: 3.4kg (7.50 lbs.)

GMC-180
GMC-220

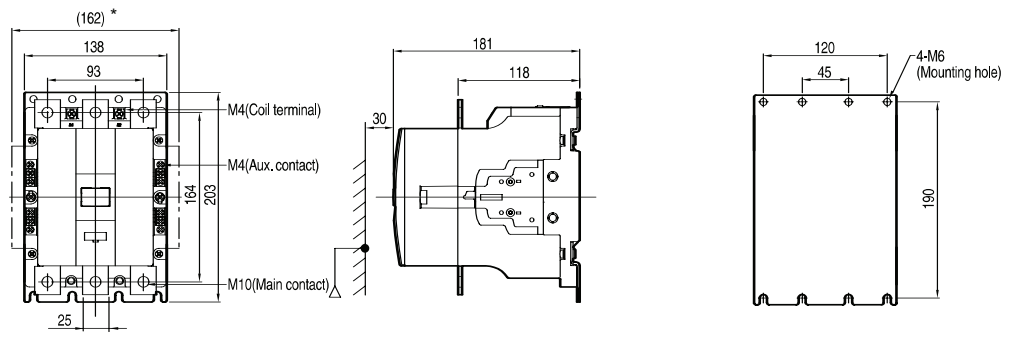

Weight: GMC-180 & 220: 5.4kg (11.91 lbs.)

GMC-100-220

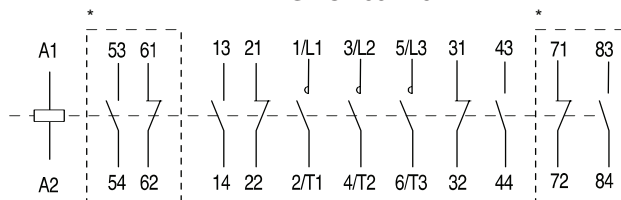

*Optional auxiliary contact unit (side mount type)

3-pole Contactors

(Dimensions shown in mm, to convert to inches multiply by 0.03937)

GMC-300

GMC-400

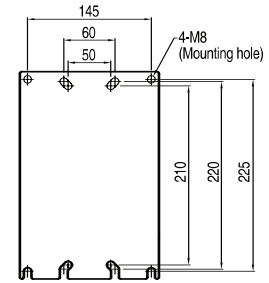
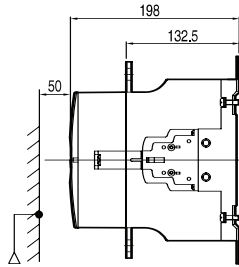
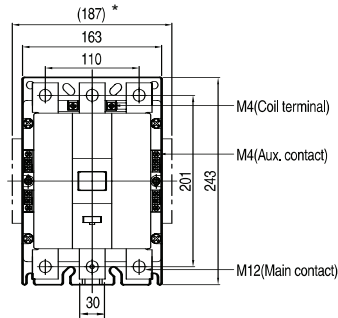

Weight: GMC-300 & 400: 9.2kg (20.29 lbs.)

GMC-600

GMC-800

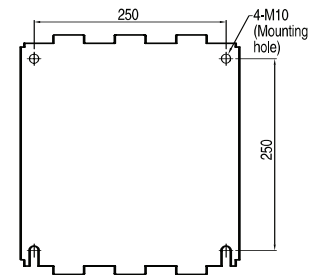
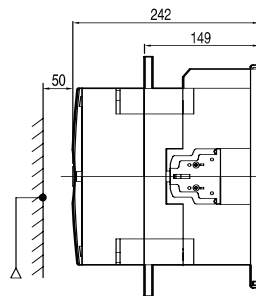
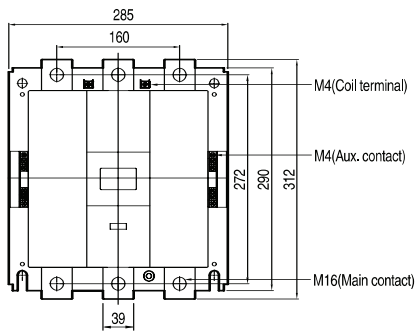

Weight: GMC-600 & 800: 22.4kg (49.39 lbs.)

GMC-300-800

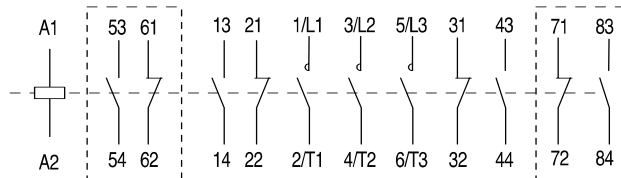

Thermal Overload Relays

(Dimensions shown in mm, to convert to inches multiply by 0.03937)

- GTH-22**
- GTK-22**
- GTH-22/3**

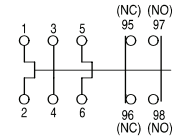
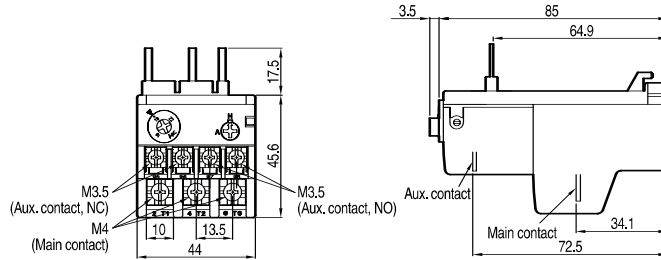

Weight: GTH-22, GTK-22 & GTH-22/3: 0.11kg (0.24 lbs.)

- GTH-40**
- GTK-40**
- GTH-40/3**

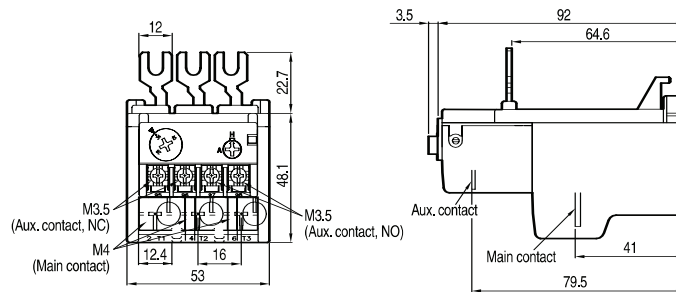

**GTH-22/3, 40/3, 85/3
GTK-22, 40, 85
(3 heater types)**

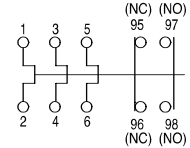

Weight: GTH-40, GTK-40 & GTH-40/3: 0.17kg (0.37 lbs.)

- GTH-85**
- GTK-85**
- GTH-85/3**

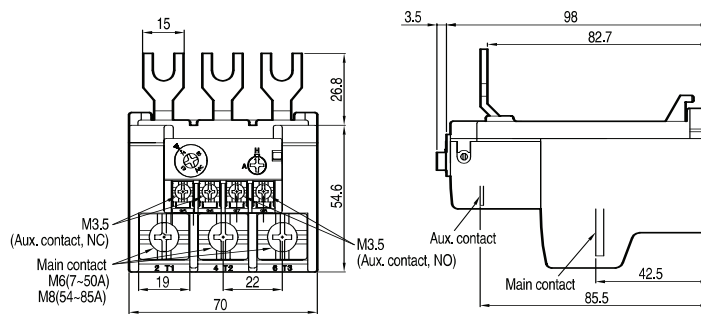

Weight: GTH-85, GTK-85 & GTH-85/3: 0.3kg (0.66 lbs.)

Separate mounting units for overload relays

(Dimensions shown in mm, to convert to inches multiply by 0.03937)

- AZ-22H**

for use with
overload relay
GTH(K)-22

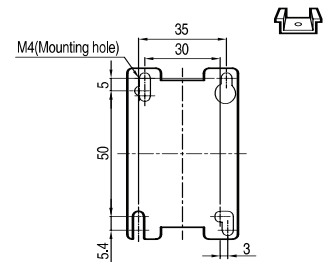
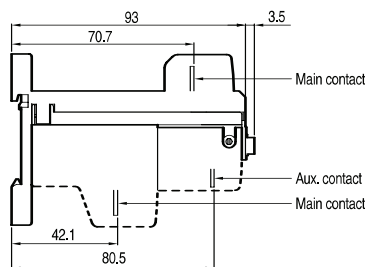

*Optional auxiliary contact unit (side mount type)

Weight: AZ-22H: 44g (0.097 lbs.)

Separate Mounting Units for Overload Relays

(Dimensions shown in mm, to convert to inches multiply by 0.03937)

AZ-40H

for use with
overload relay
GTH(K)-40

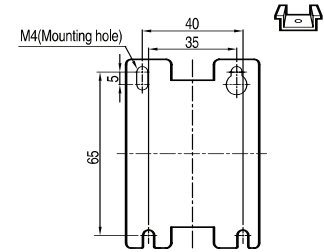
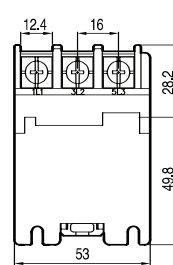
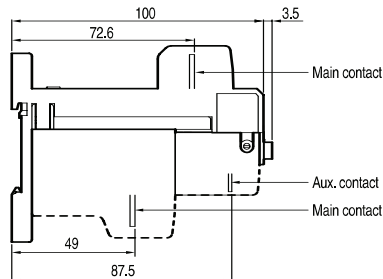

Weight: AZ-40H: 72g (0.16 lbs.)

AZ-85H

for use with
overload relay
GTH(K)-85

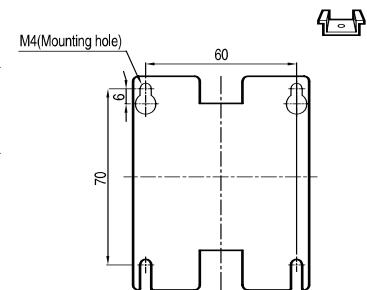
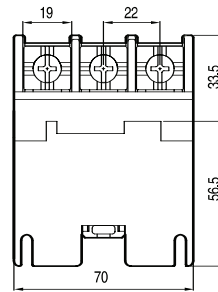
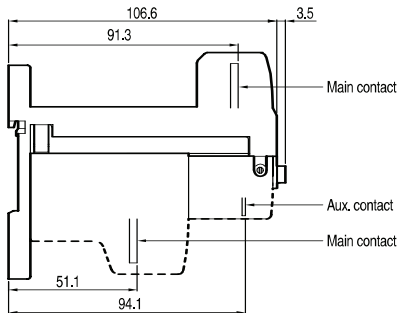

Weight: AZ-85H: 144g (0.32 lbs.)

Mini Contactors

(Dimensions shown in mm, to convert to inches multiply by 0.03937)

GMC-12M

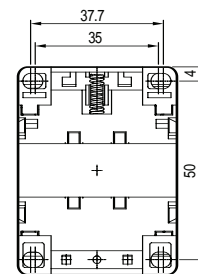
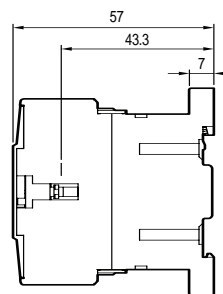
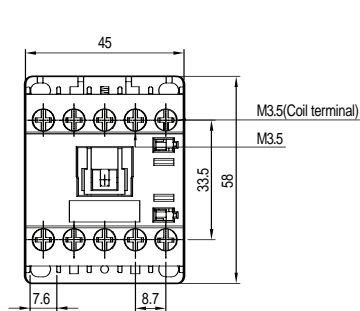

Weight: GMC-12M: 0.17kg (0.37 lbs.)

GMD-12M

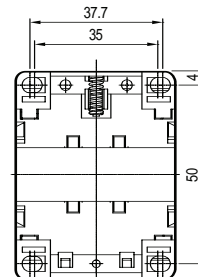
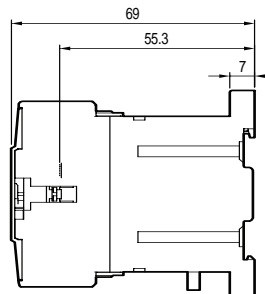
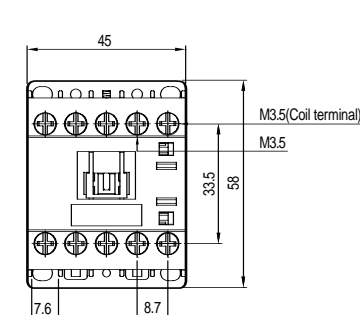

Weight: GMD-12M: 0.23kg (0.51 lbs.)

2-pole AC Contactors

(Dimensions shown in mm, to convert to inches multiply by 0.03937)

Terminal type : TSBS

- SMC-20P2
- SMC-25P2
- SMC-30P2

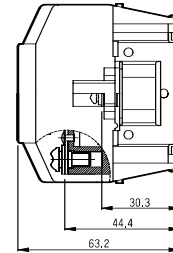
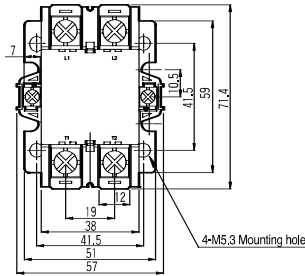

Weight: SMC-20P2, 25P2 & 30P2: 0.25kg (0.55 lbs.)

Terminal type : TQBS

- SMC-20P2
- SMC-25P2

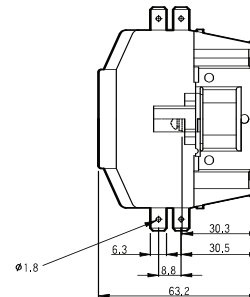
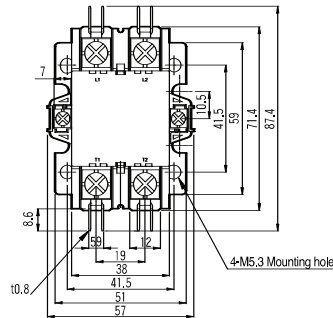

Weight: SMC-20P2 & 25P2: 0.26kg (0.57 lbs.)

Terminal type : TSBQ

- SMC-20P2
- SMC-25P2
- SMC-30P2

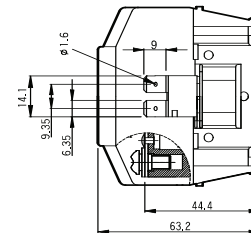
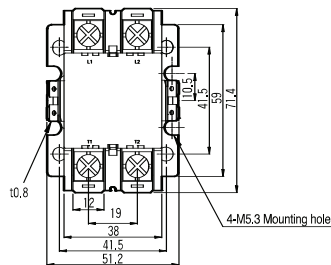

Weight: SMC-20P2, 25P2 & 30P2: 0.25kg (0.55 lbs.)

Terminal type : TQBQ

- SMC-20P2
- SMC-25P2

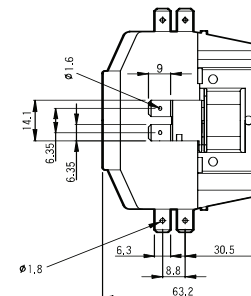
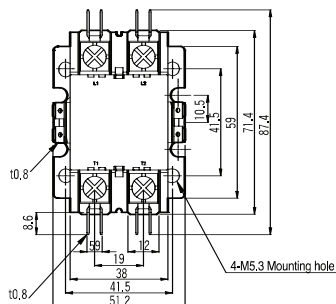

*Optional auxiliary contact unit (side mount type)

Weight: SMC-20P2 & 25P2: 0.26kg (0.57 lbs.)