

used for: D-SUB COMBINATION

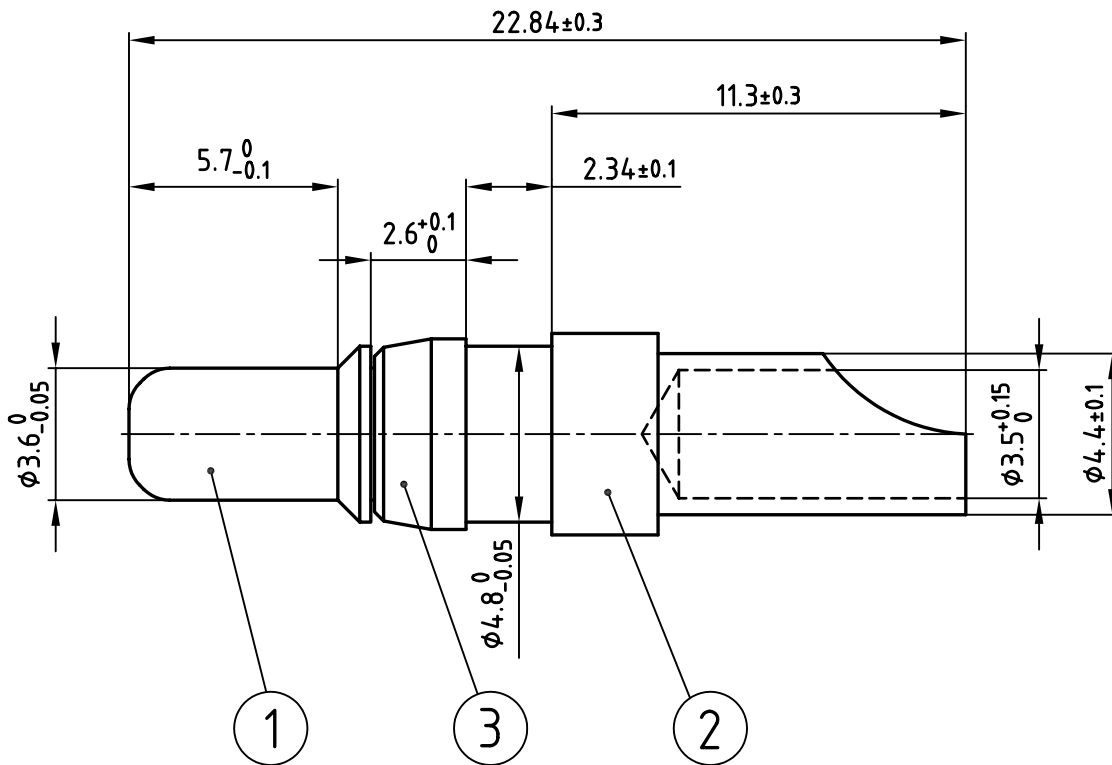

NOTES:

- 1. MATERIAL: COPPER ALLOY
- 2. PLATING:
 ITEM 1: min. 30µ" HARD GOLD OVER min. 50µ" NICKEL
 ITEM 2: min. 8µ" HARD GOLD OVER min. 50µ" NICKEL
 ITEM 3: NICKEL PLATED



THIS DRAWING MAY NOT BE COPIED OR REPRODUCED IN ANY WAY, AND MAY NOT BE PASSED ON TO A THIRD PARTY WITHOUT WRITTEN PERMISSION.
 OWNERSHIP AND COPYRIGHT OF CONEC GmbH
 DO NOT ALTER CAD DRAWING BY HAND

tolerance		ISO 2768-m			
1998	date	name			
drawn	23.03.	Barcinski			
appd.	23.03.	Mickenbecker			
norm					
d-old					
rev.		description		date	
				name	



scale:	5:1	
material:	SEE NOTES	
title:		
HIGH POWER CONTACT MALE SOLDER CUP 30A D-SUB COMBINATION		
dwg no:	CAD/ REL.13	DIN-A
	13K11C9A	4
		sh: 1/1
product no:	131C10039X	