

600W TRANSIENT VOLTAGE SUPPRESSOR

FEATURES

- PLASTIC PACKAGE HAS UNDERWRITERS LABORATORY FLAMMABILITY CLASSIFICATION 94V-0
- 600W SURGE CAPABILITY AT 1ms
- EXCELLENT CLAMPING CAPABILITY
- LOW ZENER IMPEDANCE
- FAST RESPONSE TIME:TYPICALLY LESS THAN 1.0 ps FROM 0 VOLTS TO BV MIN
- TYPICAL IR LESS THAN 1μA ABOVE 10V
- HIGH TEMPERATURE SOLDERING GUARANTEED:260°C/10S / .375" (9.5mm) LEAD LENGTH/5LBS., (2.3KG) TENSION
- LEAD FREE

MECHANICAL DATA

- CASE : MOLDED PLASTIC
- TERMINALS : AXIAL LEADS, SOLDERABLE PER MIL-STD-202, METHOD 208
- POLARITY : COLOR BAND DENOTED CATHODE EXCEPT BIPOLAR
- WEIGHT : 0.4 GRAMS

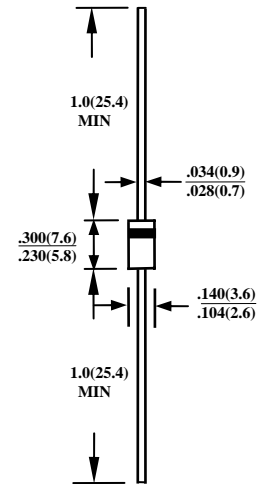

CASE : DO15
DIMENSIONS IN INCHES AND (MILLIMETERS)

**MAXIMUM RATINGS AND ELECTRICAL CHARACTERISTICS
RATINGS AT 25°C AMBIENT TEMPERATURE UNLESS OTHERWISE SPECIFIED**

RATINGS	SYMBOL	VALUE	UNITS
PEAK POWER DISSIPATION AT TA=25°C, TP=1ms(NOTE 1)	P _{PK}	600	WATTS
PEAK PULSE CURRENT WITH A 10/1000us WAVEFORM(NOTE 1)	I _{PPM}	SEE NEXT TABLE	A
STEADY STATE POWER DISSIPATION AT T _L =75°C, LEAD LENGTHS 0.375" (9.5mm) (NOTE2)	P _{M(AV)}	5.0	WATTS
PEAK FORWARD SURGE CURRENT, 8.3ms SINGLE HALF SINE-WAVE SUPERIMPOSED ON RATED LOAD (JEDEC METHOD) (NOTE 3)	I _{FSM}	100	Amps
TYPICAL THERMAL RESISTANCE JUNCTUION-TO-AMBIENT	R _{θJA}	75	°C/W
OPERATING AND STORAGE TEMPERATURE RANGE	T _J ,T _{STG}	- 55 TO + 175	°C

- NOTE :
1. NON-REPETITIVE CURRENT PULSE, PER FIG.3 AND DERATED ABOVE TA=25°C PER FIG 2.
 2. MOUNTED ON COPPER PAD AREA OF 1.6x1.6" (40x40mm) PER FIG. 5
 3. 8.3ms SINGLE HALF SINE-WAVE, DUTY CYCLE=4 PULSES PER MINUTES MAXIMUM
 4. FOR BIDIRECTIONAL USE C SUFFIX FOR 10% TOLERANCE, CA SUFFIX FOR 5% TOLERANCE

DEVICE	BREAKDOWN VOLTAGE		@IT (mA)	WORKING PEAK REVERSE VOLTAGE V_{RWM} (VOLTS)	MAXIMUM REVERSE LEAKAGE AT V_{RWM} IR(μ A)	MAXIMUM REVERSE CURRENT I_{RSM} (AMPS)	MAX CLAMPING VOLTAGE V_{RWM} (VOLTS)	MAXIMUM TEMPERATURE COEFFICIENT OF V_{BR} (%C)
	B_{BR} (VOLTS)							
	MIN	MAX						
P6KE6.8(C)-LF	6.12	7.48	10	5.50	1000	56	10.8	0.057
P6KE6.8(C)A-LF	6.45	7.14	10	5.80	1000	57	10.5	0.057
P6KE7.5(C)-LF	6.75	8.25	10	6.05	500	51	11.7	0.061
P6KE7.5(C)A-LF	7.13	7.88	10	6.40	500	53	11.3	0.061
P6KE8.2(C)-LF	7.38	9.02	10	6.63	200	48	12.5	0.065
P6KE8.2(C)A-LF	7.79	8.61	10	7.02	200	50	12.1	0.065
P6KE9.1(C)-LF	8.19	10.0	1.0	7.37	50	44	13.8	0.068
P6KE9.1(C)A-LF	8.65	9.55	1.0	7.78	50	45	13.4	0.068
P6KE10(C)-LF	9.00	11.0	1.0	8.10	10	40	15.0	0.073
P6KE10(C)A-LF	9.50	10.5	1.0	8.55	10	41	14.5	0.073
P6KE11(C)-LF	9.90	12.1	1.0	8.92	5.0	37	16.2	0.075
P6KE11(C)A-LF	10.5	11.6	1.0	9.40	5.0	38	15.6	0.075
P6KE12(C)-LF	10.8	13.2	1.0	9.72	5.0	35	17.3	0.078
P6KE12(C)A-LF	11.4	12.6	1.0	10.2	5.0	36	16.7	0.078
P6KE13(C)-LF	11.7	14.3	1.0	10.5	5.0	32	19.0	0.081
P6KE13(C)A-LF	12.4	13.7	1.0	11.1	5.0	33	18.2	0.081
P6KE15(C)-LF	13.5	16.5	1.0	12.1	5.0	27	22.0	0.084
P6KE15(C)A-LF	14.3	15.8	1.0	12.8	5.0	28	21.2	0.084
P6KE16(C)-LF	14.4	17.6	1.0	12.9	5.0	26	23.5	0.086
P6KE16(C)A-LF	15.2	16.8	1.0	13.6	5.0	27	22.5	0.086
P6KE18(C)-LF	16.2	19.8	1.0	14.5	5.0	23	26.5	0.088
P6KE18(C)A-LF	17.1	18.9	1.0	15.3	5.0	24	25.2	0.088
P6KE20(C)-LF	18.0	22.0	1.0	16.2	5.0	21	29.1	0.090
P6KE20(C)A-LF	19.0	21.0	1.0	17.1	5.0	22	27.7	0.090
P6KE22(C)-LF	19.8	24.2	1.0	17.8	5.0	19	31.9	0.092
P6KE22(C)A-LF	20.9	23.1	1.0	18.8	5.0	20	30.6	0.092
P6KE24(C)-LF	21.6	26.4	1.0	19.4	5.0	17	34.7	0.094
P6KE24(C)A-LF	22.8	25.2	1.0	20.5	5.0	18	33.2	0.094
P6KE27(C)-LF	24.3	29.7	1.0	21.8	5.0	15	39.1	0.096
P6KE27(C)A-LF	25.7	28.4	1.0	23.1	5.0	16	37.5	0.096
P6KE30(C)-LF	27.0	33.0	1.0	24.3	5.0	14	43.5	0.097
P6KE30(C)A-LF	28.5	31.5	1.0	25.6	5.0	14.4	41.4	0.097
P6KE33(C)-LF	29.7	36.3	1.0	26.8	5.0	12.6	47.7	0.098
P6KE33(C)A-LF	31.4	34.7	1.0	28.2	5.0	13.2	45.7	0.098
P6KE36(C)-LF	32.4	39.6	1.0	29.1	5.0	11.6	52.0	0.099
P6KE36(C)A-LF	34.2	37.8	1.0	30.8	5.0	12.0	49.9	0.099
P6KE39(C)-LF	35.1	42.9	1.0	31.6	5.0	10.6	56.4	0.100
P6KE39(C)A-LF	37.1	41.0	1.0	33.3	5.0	11.2	53.9	0.100
P6KE43(C)-LF	38.7	47.3	1.0	34.8	5.0	9.6	61.9	0.101
P6KE43(C)A-LF	40.9	45.2	1.0	36.8	5.0	10.1	59.3	0.101
P6KE47(C)-LF	42.3	51.7	1.0	38.1	5.0	8.9	67.8	0.101
P6KE47(C)A-LF	44.7	49.4	1.0	40.2	5.0	9.3	64.8	0.101
P6KE51(C)-LF	45.9	56.1	1.0	41.3	5.0	8.2	73.5	0.102
P6KE51(C)A-LF	48.5	53.6	1.0	43.6	5.0	8.6	70.1	0.102
P6KE56(C)-LF	50.4	61.6	1.0	45.4	5.0	7.4	80.5	0.103
P6KE56(C)A-LF	53.2	58.8	1.0	47.8	5.0	7.8	77.0	0.103
P6KE62(C)-LF	55.8	68.2	1.0	50.2	5.0	6.8	89.0	0.104
P6KE62(C)A-LF	58.9	65.1	1.0	53.0	5.0	7.1	85.0	0.104
P6KE68(C)-LF	61.2	74.8	1.0	55.1	5.0	6.1	98.0	0.104
P6KE68(C)A-LF	64.6	71.4	1.0	58.1	5.0	6.5	92.0	0.104
P6KE75(C)-LF	67.5	82.5	1.0	60.7	5.0	5.5	108.0	0.105
P6KE75(C)A-LF	71.3	78.8	1.0	64.1	5.0	5.8	103.0	0.105
P6KE82(C)-LF	73.8	90.2	1.0	66.4	5.0	5.1	118.0	0.105
P6KE82(C)A-LF	77.9	86.1	1.0	70.1	5.0	5.3	113.0	0.105
P6KE91(C)-LF	81.9	100.0	1.0	73.7	5.0	4.5	131.8	0.106
P6KE91(C)A-LF	86.5	95.50	1.0	77.8	5.0	4.8	125.0	0.106
P6KE100(C)-LF	90.0	110.0	1.0	81.0	5.0	4.2	144.0	0.106
P6KE100(C)A-LF	95.0	105.0	1.0	85.5	5.0	4.4	137.0	0.106

DEVICE	BREAKDOWN VOLTAGE		@IT (mA)	WORKING PEAK REVERSE VOLTAGE V_{RWM} (VOLTS)	MAXIMUM REVERSE LEAKAGE AT V_{RWM} $I_R(\mu A)$	MAXIMUM REVERSE CURRENT I_{RSM} (AMPS)	MAX CLAMPING VOLTAGE V_{RWM} (VOLTS)	MAXIMUM TEMPERATURE COEFFICIENT OF V_{RR} (%C)
	B_{BR} (VOLTS)							
	MIN	MAX						
P6KE110(C)-LF	99.0	121.0	1.0	89.2	5.0	3.8	158.0	0.107
P6KE110(C)A-LF	105.0	116.0	1.0	94.0	5.0	4.0	152.0	0.107
P6KE120(C)-LF	108.0	132.0	1.0	97.2	5.0	3.5	173.0	0.107
P6KE120(C)A-LF	114.0	126.0	1.0	102.0	5.0	3.6	165.0	0.107
P6KE130(C)-LF	117.0	143.0	1.0	105.0	5.0	3.2	187.0	0.107
P6KE130(C)A-LF	124.0	137.0	1.0	111.0	5.0	3.3	179.0	0.107
P6KE150(C)-LF	135.0	165.0	1.0	121.0	5.0	2.8	215.0	0.108
P6KE150(C)A-LF	143.0	158.0	1.0	128.0	5.0	2.9	207.0	0.108
P6KE160(C)-LF	144.0	176.0	1.0	130.0	5.0	2.6	230.0	0.108
P6KE160(C)A-LF	152.0	168.0	1.0	136.0	5.0	2.7	219.0	0.108
P6KE170(C)-LF	153.0	187.0	1.0	138.0	5.0	2.5	244.0	0.108
P6KE170(C)A-LF	162.0	179.0	1.0	145.0	5.0	2.6	234.0	0.108
P6KE180(C)-LF	162.0	198.0	1.0	146.0	5.0	2.3	258.0	0.108
P6KE180(C)A-LF	171.0	189.0	1.0	154.0	5.0	2.4	246.0	0.108
P6KE200(C)-LF	180.0	220.0	1.0	162.0	5.0	2.1	287.0	0.108
P6KE200(C)A-LF	190.0	210.0	1.0	171.0	5.0	2.2	274.0	0.108
P6KE220(C)-LF	198.0	242.0	1.0	175.0	5.0	1.75	344.0	0.108
P6KE220(C)A-LF	209.0	231.0	1.0	185.0	5.0	1.83	328.0	0.108
P6KE250(C)-LF	225.0	275.0	1.0	202.0	5.0	1.67	360.0	0.110
P6KE250(C)A-LF	237.0	263.0	1.0	214.0	5.0	1.75	344.0	0.110
P6KE300(C)-LF	270.0	330.0	1.0	243.0	5.0	1.4	430.0	0.110
P6KE300(C)A-LF	285.0	315.0	1.0	256.0	5.0	1.45	414.0	0.110
P6KE350(C)-LF	315.0	385.0	1.0	284.0	5.0	1.2	504.0	0.110
P6KE350(C)A-LF	332.0	368.0	1.0	300.0	5.0	1.25	482.0	0.110
P6KE400(C)-LF	360.0	440.0	1.0	324.0	5.0	1.05	574.0	0.110
P6KE400(C)A-LF	380.0	420.0	1.0	342.0	5.0	1.1	548.0	0.110
P6KE440(C)-LF	396.0	484.0	1.0	356.0	5.0	0.95	630.0	0.110
P6KE440(C)A-LF	418.0	462.0	1.0	376.0	5.0	1.00	600.0	0.110
P6KE480(C)-LF	432.0	528.0	1.0	389.0	5.0	0.88	686.0	0.110
P6KE480(C)A-LF	456.0	504.0	1.0	408.0	5.0	0.91	658.0	0.110
P6KE510(C)-LF	459.0	561.0	1.0	413.0	5.0	0.82	729.0	0.110
P6KE510(C)A-LF	485.0	535.0	1.0	434.0	5.0	0.86	698.0	0.110
P6KE540(C)-LF	486.0	594.0	1.0	437.0	5.0	0.78	772.0	0.110
P6KE540(C)A-LF	513.0	567.0	1.0	459.0	5.0	0.81	740.0	0.110

- NOTES : 1. V_{BR} MEASURED AFTER I_T APPLIED FOR 300 μS , I_T =SQUARE WAVE PULSE OR EQUIVALENT
2. SURGE CURRENT WAVEFORM PER FIGURE 3 AND DERATED PER FIGUE 2.
3. V_F =3.5V AT I_F =50A (P6KE6.8(C) THRU P6KE200(C)A)
 V_F =6.5V AT I_F =50A (P6KE220(C) THRU P6KE540(C)A) ON 1/2 SQUARE OR EQUIVALENT SINE WAVE.
PW=8.3ms, DUTY CYCLE=4 PULSES PER MINUTE MXIMUM
4. FOR BIPOLAR TYPES HAVING V_{RWM} OF 10 VOLTS AND UNDER, THE I_R LIMIT IS DOUBLED

RATINGS AND CHARACTERISTIC CURVES P6KE6.8(C)-LF THRU P6KE540(C)A-LF

FIG. 1 - PEAK PULSE POWER RATING CURVE

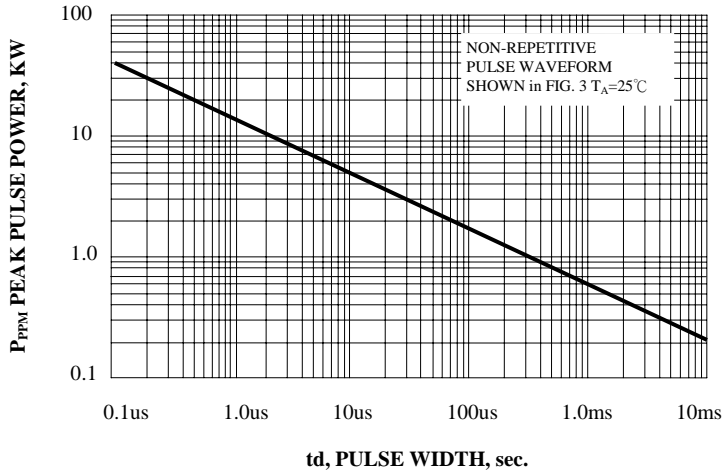

FIG. 2 - PULSE DERATING CURVE

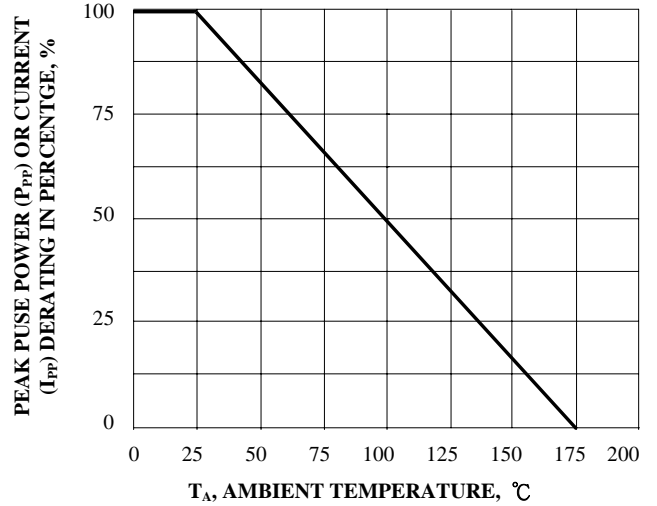

FIG. 3 - PULSE WAVEFORM

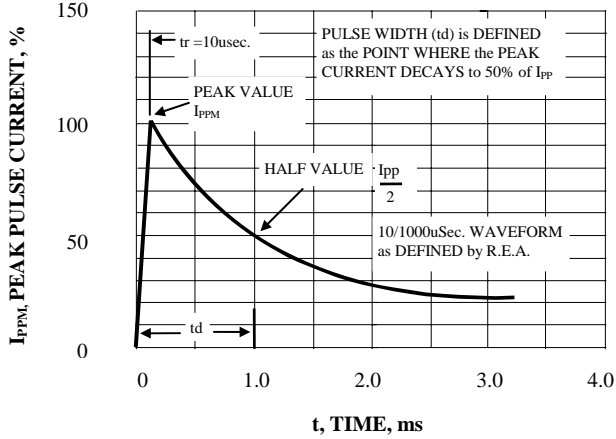

FIG. 4 - TYPICAL JUNCTION CAPACITANCE UNIDIRECTIONAL

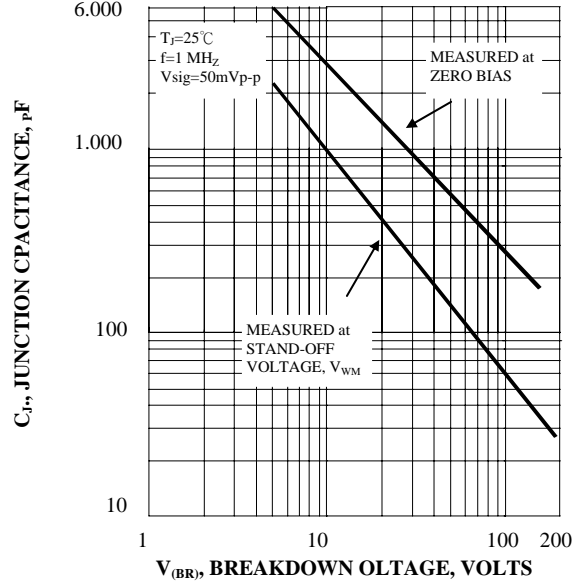

FIG. 5 - STEADY STATE POWER DERATING CURVE

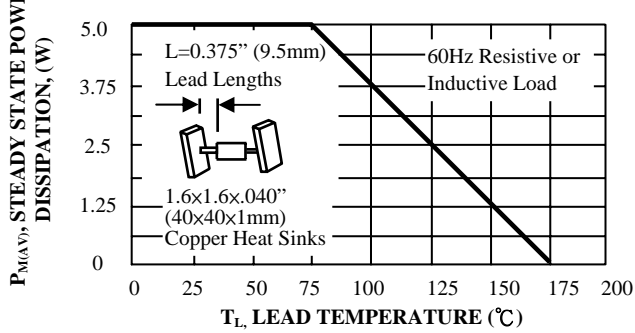

FIG. 6 - TYPICAL REVERSE LEAKAGE CHARACTERISTICS

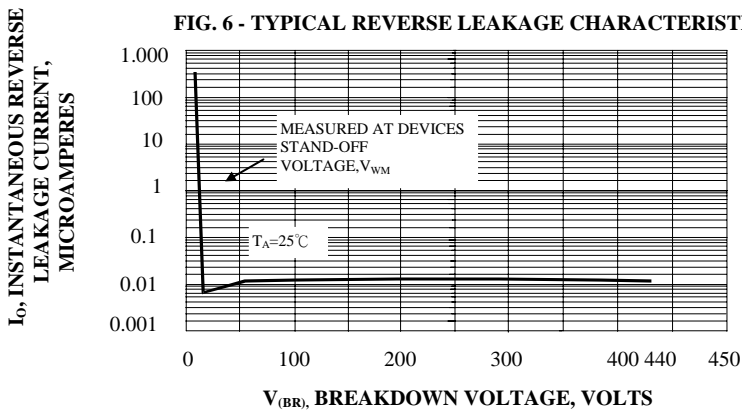

FIG. 7 - MAXIMUM NON-REPETITIVE FORWARD SURGE CURRENT UNIDIRECTIONAL

