

CFT-90 Converted Green High Brightness Green LED

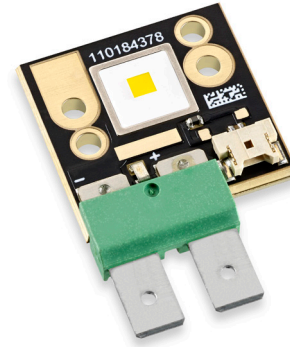

Table of Contents

Technology Overview	2
Test Specifications	2
Binning Structure	3
Ordering Information	4
Optical and Electrical Characteristics	5-7
Thermal Resistance	8
Mechanical Dimensions	9
Packaging Information	10-11
Revision History	12

Features:

- Large, monolithic chip with uniform emitting area of 9 mm²
- Phosphor Converted Green LED device with typical center wavelength emission of 579 nm
- Windowless package improves coupling-efficiency into fiber optics
- Common Anode package design with low thermal resistance of 0.45C/W typical (junction to case)
- Ultra High thermal conductivity package allows operation at up to 22.5A CW.
- High precision LEDs placement on copper core PCB for easier thermal management and optical integration
- Environmentally friendly: RoHS and Halogen compliant

Applications:

- Fluorescence Microscopy and imaging
- Medical Endoscopy

Technology Overview

Luminus LEDs™ benefit from a suite of innovations in the fields of chip technology, packaging and thermal management. These breakthroughs allow illumination engineers and designers to achieve solutions that are high brightness and high efficiency.

Luminus LED Technology

Luminus' Devices vertical chip LED technology enables large area LED chips with uniform brightness over the entire LED chip surface. The optical power and brightness produced by these large monolithic chips enable solutions which replace arc and halogen lamps where arrays of traditional high power LEDs cannot.

Packaging Technology

Thermal management is critical in high power LED applications. With a thermal resistance from junction to heat sink of 0.7° C/W, Luminus CFT-90 LEDs have the lowest thermal resistance of any LED on the market. This allows the LED to be driven at higher current densities while maintaining a low junction temperature, thereby resulting in brighter solutions and longer lifetimes.

Reliability

Designed from the ground up, Luminus LEDs are one of the most reliable light sources in the world today. Luminus LEDs have passed a rigorous suite of environmental and mechanical stress tests, including mechanical shock, vibration, temperature cycling and humidity, and have been fully qualified for use in extreme high power and high current applications. With very low failure rates and median lifetimes that typically exceed 60,000 hours, Luminus LEDs are ready for even the most demanding applications.

Environmental Benefits

Luminus LEDs help reduce power consumption and the amount of hazardous waste entering the environment. All LED products manufactured by Luminus are RoHS compliant and free of hazardous materials, including lead and mercury.

Understanding Luminus LED Test Specifications

Every Luminus LED is fully tested to ensure that it meets the high quality standards expected from Luminus' products.

Testing of Luminus LEDs

Luminus core board products are typically measured in such a way that the characteristics reported agree with how the devices will actually perform when incorporated into a system. This measurement is accomplished by mounting the devices on a 40°C heat sink and allowing the device to reach thermal equilibrium while fully powered. Only after the device reaches equilibrium are the measurements taken. This method of measurement ensures that Luminus LEDs perform in the field just as they are specified.

Expected flux values in real world operation can be extrapolated based on the information contained within this product data sheet.

CFT-90-CG Binning Structure

All CFT-90 Converted Green LEDs are tested for radiometric power / center wavelength and placed into the following flux/ wavelength bins. The binning structure is universally applied across each monochromatic color of the CFT-90 product line.

Radiometric Power Bins*

Bin name	Min Radiometric Power (W) @ 22.5A CW	Max Radiometric Power (W) @ 22.5A CW
CG1	9.08	9.78
CG2	9.78	11.38
CG3	11.38	13.69

Note: Luminus maintains a +/-6% tolerance in flux measurements.

Center Wavelength Bins

Bin name	Min Center Wavelength @ 22.5A CW	Max Center Wavelength @ 22.5 CW
CG1, CG2 and CG3	573	585

Ordering Information

Ordering Part Number ^{1,2,3}	Minimum Bin	Description
CFT-90-CG-L11-G100	CG1 min	Converted Green LED™ CFT-90 consisting of 9 mm ² LED, thermistor, and connector mounted on a custom copper-core PCB - Full Center WL distribution

Part Number Nomenclature

CFT — 90 — CC — L## — FF###

Product Family	Chip Area	Color	Package Configuration	Bin Kit ^{1,2}
CFT: Copper-core PCB, No Encapsulation	90: 9 mm ²	CG= Converted Green	L11: 28 mm x 26.75 mm - Common Anode Package See Mechanical Drawing section	See flux and power bins on page 3

Note 1: A Bin Kit represents a group of individual flux or power bins that are shippable for a given ordering part number. Individual flux bins are not orderable.

Note 2: Flux Bin listed is minimum bin shipped - higher bins may be included at Luminus' discretion

Optical & Electrical Characteristics

Typical Device Performance

General Characteristics		Symbol	Converted Green	Unit
Emitting Area			9.0	mm ²
Emitting Area Dimensions			3.0x3.0	mm x mm
Characteristics at Recommended Test Drive Current, $I_f^{1,2}$				
Reference Duty Cycle			100	%
Test Peak Drive Current	typ	I_F	22.5	A
Radiometric Power ^{3,4,5}	min	$\Phi_{r\ min}$	9.08	W
	typ	Φ_r	10.8	W
	max	$\Phi_{r\ max}$	13.69	W
Filtered Radiometric Power in [500 to 600nm] range (for reference only).	min	$\Phi_{fr\ min}$	5.9	W
	typ	Φ_{fr}	7.0	W
	max	$\Phi_{fr\ max}$	8.9	W
Center Wavelength ³	min	$\lambda_{c\ min}$	573	nm
	typ	λ_c	579	nm
	max	$\lambda_{c\ max}$	585	nm
FWHM- Spectral bandwidth at 50% of Φ_V ³	min		91	nm
	typ	FWHM	103	nm
	max		115	nm
Forward Voltage ³	min	$V_{F\ min}$	3.2	V
	typ	V_F	3.8	V
	max	$V_{F\ max}$	4.4	V
Device Thermal Characteristics				
Thermal Coefficient of Photometric Flux	typ		-0.3	% / °C
Thermal Coefficient of Radiometric Flux	typ		-0.3	% / °C
Forward Voltage Temperature Coefficient	typ		-2	mV/ °C
Angular Distribution Pattern				
Viewing angle at 50 % I_V^9		2ϕ	120	degrees

Optical & Electrical Characteristics

Absolute Maximum Ratings

	Symbol	Converted Green	Unit
Absolute Minimum Current (CW or Pulsed) ^{6,7}		0.2	A
Absolute Maximum Current (CW) ⁸		22.5	A
Absolute Maximum Surge Current ⁸ (Frequency > 240 Hz, duty cycle =10%, t=1ms)		36	A
Absolute Maximum Junction Temperature ⁸	T _{jmax}	170	°C
Storage Temperature Range		-40/+100	°C

Note 1: All ratings are based on operation with a constant heat sink temperature $T_{hs}=40^{\circ}\text{C}$. See Thermal Resistance section for T_{hs} definition.

Note 2: CFT-90 Converted Green devices can be driven at currents ranging from 200mA to 36A and at duty cycles ranging from 1% to 100%. Drive current and duty cycle should be adjusted as necessary to maintain the junction temperature desired to meet application lifetime requirements. In pulsed operation, rise time from 10-90% of forward current should be larger than 0.5 microseconds.

Note 3: Unless otherwise noted, values listed are typical. Devices are production tested and specified at 22.5 A.

Note 4: Typical junction temperature at test ($T_{hs}=40^{\circ}\text{C}$, 22.5A CW) is around 120°C.

Note 5: Caution must be taken not to stare at the light emitted from these LEDs. Under special circumstances, the high intensity could damage the eye.

Note 6: For reference only.

Note 7: Special design considerations must be observed for operation under 1 A. Please contact Luminus for further information.

Note 8: CFT-90 Converted Green LEDs are designed for operation to an absolute maximum current and temperature as specified above. Product lifetime data is specified at recommended forward drive currents. Sustained operation at or beyond absolute maximum currents or temperatures will result in a reduction of device lifetime compared to recommended conditions. Refer to the lifetime derating curves for further information.

Note 9: Angular Distribution parameter is guaranteed by design and is not measured in Production.

Note 10: Filtered Radiometric Power from emitting area in the 500 to 600nm wavelength range. For reference only.

Optical & Electrical Characteristics

Relative Output Flux vs. Forward Current

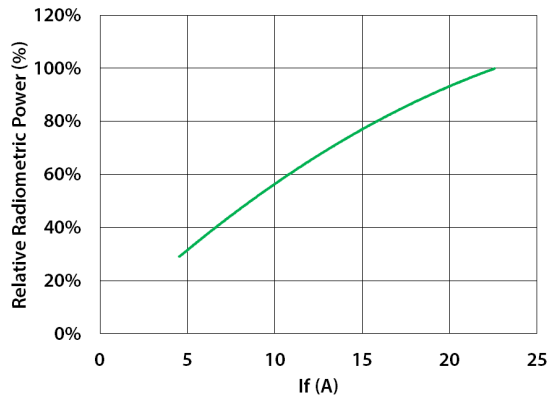

Forward Current vs. Forward Voltage

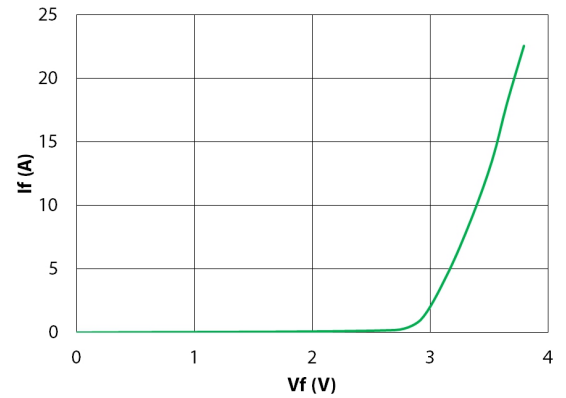

Angular Intensity Distribution (Typical)

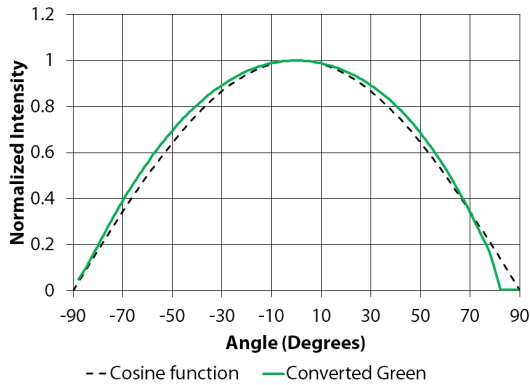

Typical Spectrum

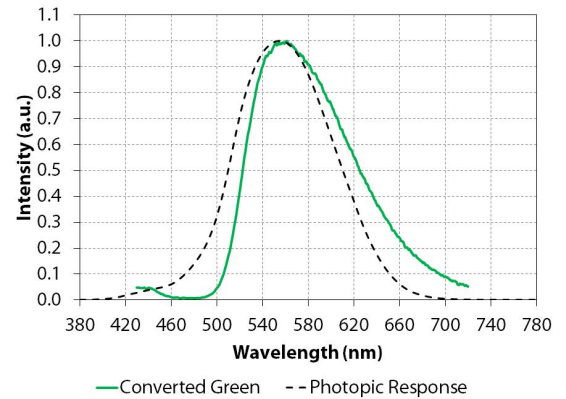

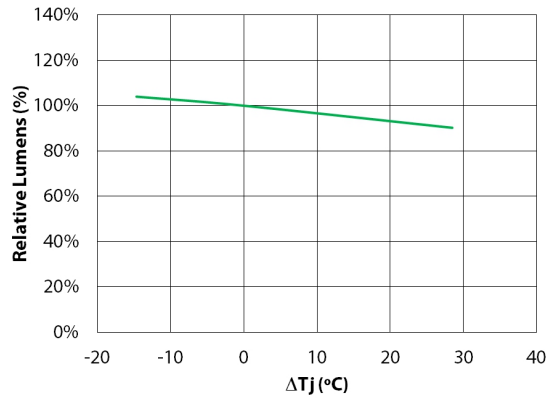
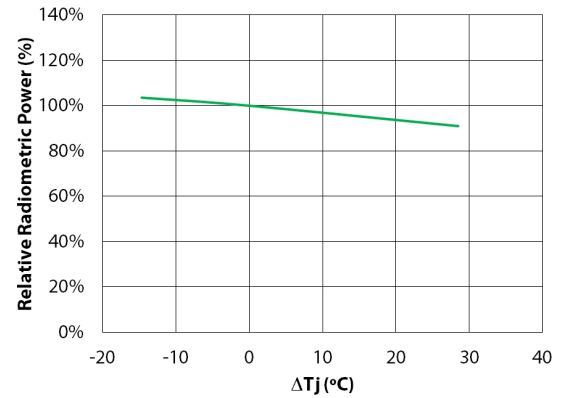
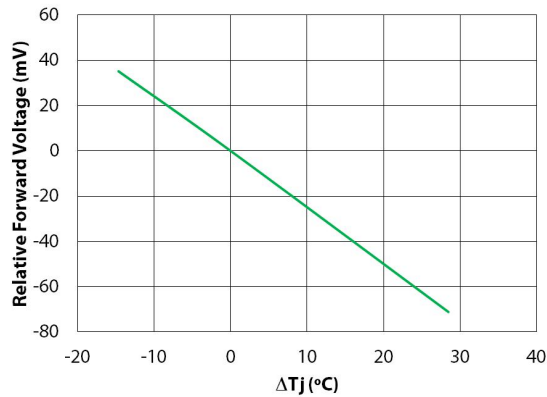
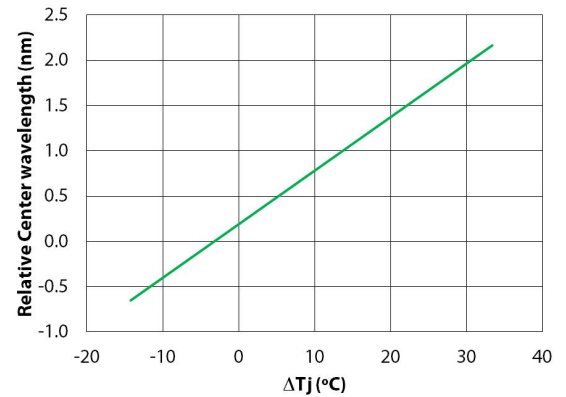
Light Output Characteristics Over Junction Temperature
Relative Lumens vs. Temperature

Relative Radiometric Power vs. Temperature

Relative Forward Voltage vs. Temperature

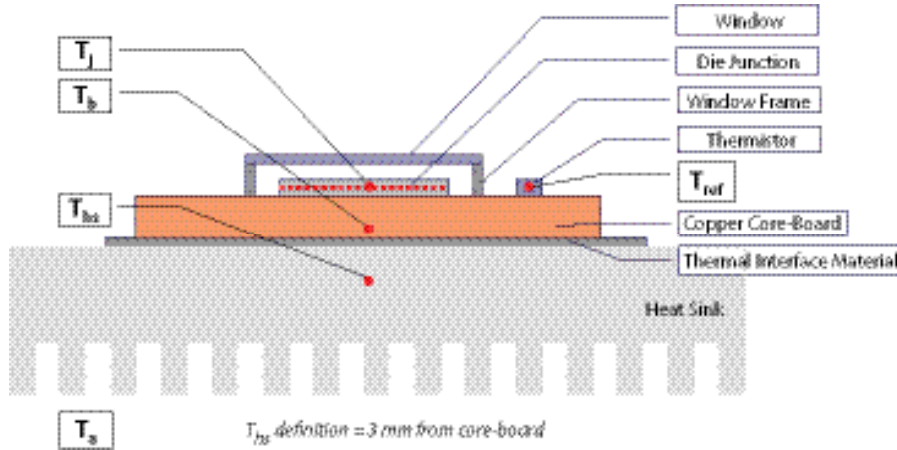
Relative Center Wavelength vs. Temperature

Thermal Resistance

Typical Thermal Resistance



$R_{\theta j-b}^1$	0.45 °C/W
$R_{\theta b-hs}^1$	0.2 °C/W
$R_{\theta j-hs}^2$	0.7 °C/W
$R_{\theta j-ref}^1$	0.5 °C/W

Note 1: Thermal resistance values are based on FEA model results correlated to measured $R_{\theta j-hs}$ data.

Note 2: Thermal resistance is measured using eGraf 1205 thermal interface material.

Thermistor Information

The thermistor used in CFT-90 LEDs mounted on core-boards is from Murata Manufacturing Co. The global part number is NCP18XH103J03RB. Please see <http://www.murata.com/> for details on calculating thermistor temperature.

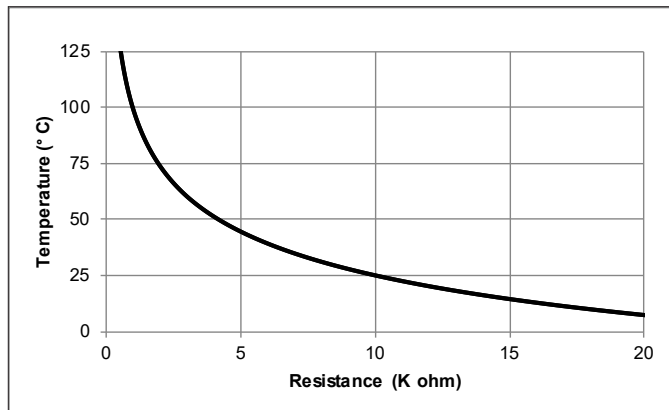

Electrical Pinout

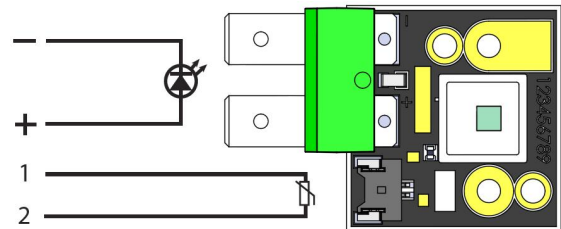

Shipping Tray Outline

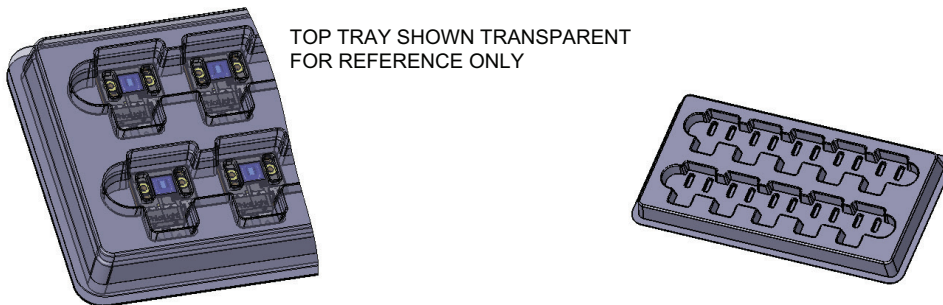
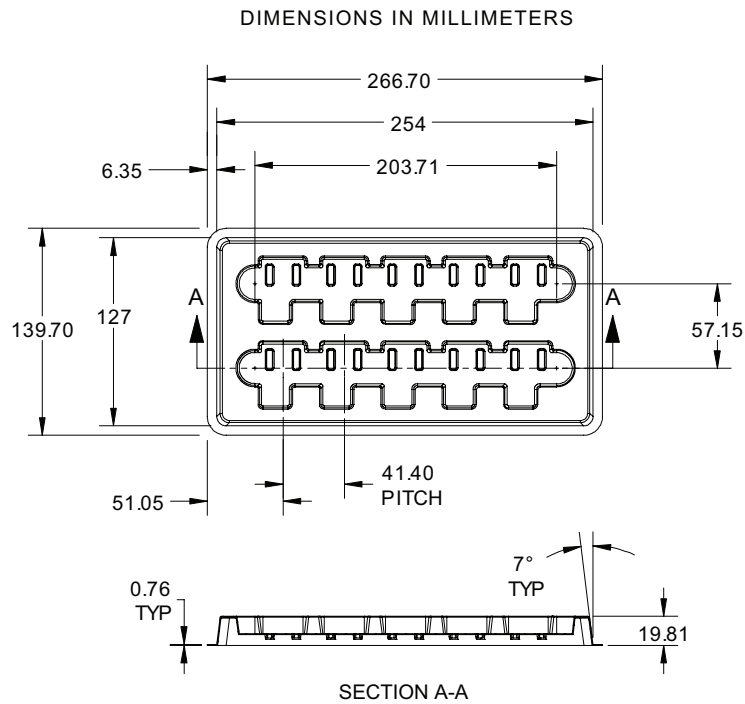

For detailed drawing of shipping trays, please refer to document TO-0479, available upon request.

Packing and Shipping Specification (CFT-90)

Packing Specification

Packing Configuration	Qty /Pack	Reel Dimensions (diameter x W, mm)	Gross Weight (kg)
Stack of 5 trays with 10 devices per tray Each pack is enclosed in ESD bag	50	150 x 280 x 85	2.7







Product Label Specification

Label Fields (subject to change):

- 6-8 digit Box number (for Luminus internal use)
- Luminus ordering part number
- Quantity of devices in pack
- Part number revision (for Luminus internal use)
- Customer's part number (optional)
- Bin (FF-WW) as defined page 3
- 2D Bar code



LUMINUS
LEADER IN BIG CHIP LEDS Solid State Filament™

BT-012345  <small>Box number</small>	Qty: 50 	
PT-120-G-L11-MPG  <small>Luminus part number</small>	Rev 01 	
12345678  <small>Customer part number</small>		
5F  <small>Bin</small>		

RoHS Compliant

Sample label –for illustration only

for traceability peel off label and attach

Shipping Box

Shipping Box	Quantity	Material	Dimensions (L x W x H, mm)
Carton Box	1 -20 packs (50 - 1000 Devices)	S4651	560 x 560 x 200



History of Changes

Rev		Description of Change
01	02/20/2018	Initial Release - Preliminary Specifications
02	06/07/2018	Removed note 3 on page 4
03	06/20/2018	Revised Relative Output Flux vs. Forward Current graph on page 7

Luminus Devices assumes no liability for errors that may appear in this document, and no liability otherwise arising from the application or use of the product or information contained herein. None of the information provided herein should be considered to be a representation of the fitness or suitability of the product for any particular application or as any other form of warranty. Luminus Devices' product warranties are limited to only such warranties as accompany a purchase contract or purchase order for such products. Nothing herein is to be construed as constituting an additional warranty. No information contained in this publication may be considered as a waiver by Luminus Devices of any intellectual property rights that Luminus Devices may have in such information.

This product is protected by U.S. Patents 6,831,302; 7,074,631; 7,083,993; 7,084,434; 7,098,589; 7,105,861; 7,138,666; 7,166,870; 7,166,871; 7,170,100; 7,196,354; 7,211,831; 7,262,550; 7,274,043; 7,301,271; 7,341,880; 7,344,903; 7,345,416; 7,348,603; 7,388,233; 7,391,059 Patents Pending in the U.S. and other countries.