

Chip Ferrite Bead BLM21□□□□□□N1□ Reference Specification

1. Scope

This reference specification applies to Chip Ferrite Bead BLM21_□N Series.

2. Part Numbering

(ex.) $\frac{BL}{(1)}$ $\frac{M}{(2)}$ $\frac{21}{(3)}$ $\frac{AG}{(4)}$ $\frac{121}{(5)}$ $\frac{S}{(6)}$ $\frac{N}{(7)}$ $\frac{1}{(8)}$ $\frac{D}{(9)}$

- (1)Product ID
 - (2)Type
 - (3)Dimension (L×W)
 - (4)Characteristics
 - (5)Typical Impedance at 100MHz
 - (6)Performance
 - (7)Category
 - (8)Numbers of Circuit
 - (9)Packaging
- { D:Taping(φ 180mm Reel, Paper Tape)
 L:Taping(φ 180mm Reel, Plastic Tape)
 B:Bulk }

3. Rating

Customer Part Number	MURATA Part Number	Impedance (Ω) (at 100MHz, Under Standard Testing Condition)		Rated Current (mA)(*1)		DC Resistance (Ω) max.		Remark	
		Typical		at 85°C	at 125°C	Initial Values	Values After Testing		
	BLM21PG220SN1D BLM21PG220SN1B	22±25%	22	*1 6000	*1 3300	0.009	0.018	For DC power line	
	BLM21PG300SN1D BLM21PG300SN1B	20 min.	30	*1 4000	*1 2300	0.014	0.028		
	BLM21PG600SN1D BLM21PG600SN1B	60±25%	60	*1 3500	*1 1900	0.02	0.04		
	BLM21PG121SN1D BLM21PG121SN1B	120±25%	120	*1 3000	*1 1550	0.03	0.06		
	BLM21PG221SN1D BLM21PG221SN1B	220±25%	220	*1 2000	*1 1250	0.045	0.09		
	BLM21PG331SN1D BLM21PG331SN1B	330±25%	330	*1 1500	*1 1000	0.07	0.14		
	BLM21SN300SN1D BLM21SN300SN1B	30±10Ω	30	*1 8500	*1 6000	0.004	0.005		
	BLM21SP700SN1D BLM21SP700SN1B	70±25%	70	*1 6000	*1 4000	0.009	0.012		
	BLM21SP111SN1D BLM21SP111SN1B	110±25%	110	*1 5000	*1 3300	0.013	0.016		
	BLM21SP181SN1D BLM21SP181SN1B	180±25%	180	*1 4000	*1 2600	0.020	0.025		
	BLM21SP331SN1D BLM21SP331SN1B	330±25%	330	*1 2800	*1 1900	0.040	0.051		
	BLM21SP471SN1D BLM21SP471SN1B	470±25%	470	*1 2500	*1 1700	0.050	0.063		
	BLM21SP601SN1D BLM21SP601SN1B	600±25%	600	*1 2300	*1 1500	0.060	0.074		
	BLM21SP102SN1D BLM21SP102SN1B	1000±25%	1000	*1 1600	*1 1100	0.120	0.144		
	BLM21RK121SN1D BLM21RK121SN1B	120±25%	120	200		0.15	0.25		For Digital Interface
	BLM21RK221SN1D BLM21RK221SN1B	220±25%	220	200		0.20	0.30		
	BLM21RK471SN1D BLM21RK471SN1B	470±25%	470	200		0.25	0.35		
	BLM21RK601SN1D BLM21RK601SN1B	600±25%	600	200		0.30	0.40		
	BLM21RK102SN1D BLM21RK102SN1B	1000±25%	1000	200		0.50	0.60		

Customer Part Number	MURATA Part Number	Impedance (Ω) (at 100MHz, Under Standard Testing Condition)		Rated Current (mA)	DC Resistance (Ω) max.		Remark
			Typical		Initial Values	Values After Testing	
	BLM21BB050SN1D BLM21BB050SN1B	5 \pm 25%	5	1000	0.02	0.04	For high speed signal line
	BLM21BB600SN1D BLM21BB600SN1B	60 \pm 25%	60	800	0.13	0.23	
	BLM21BB750SN1D BLM21BB750SN1B	75 \pm 25%	75	700	0.16	0.26	
	BLM21BB121SN1D BLM21BB121SN1B	120 \pm 25%	120	600	0.19	0.29	
	BLM21BD121SN1D BLM21BD121SN1B	120 \pm 25%	120	350	0.25	0.35	
	BLM21BB151SZ1D BLM21BB151SZ1B	150 \pm 25%	150	600	0.21	0.31	
	BLM21BD151SN1D BLM21BD151SN1B	150 \pm 25%	150	350	0.25	0.35	
	BLM21BB201SN1D BLM21BB201SN1B	200 \pm 25%	200	500	0.26	0.36	
	BLM21BB221SN1D BLM21BB221SN1B	220 \pm 25%	220	500	0.26	0.36	
	BLM21BD221SN1D BLM21BD221SN1B	220 \pm 25%	220	350	0.25	0.35	
	BLM21BB331SN1D BLM21BB331SN1B	330 \pm 25%	330	400	0.33	0.43	
	BLM21BD331SN1D BLM21BD331SN1B	330 \pm 25%	330	300	0.3	0.4	
	BLM21BD421SN1D BLM21BD421SN1B	420 \pm 25%	420	300	0.3	0.4	
	BLM21BB471SN1D BLM21BB471SN1B	470 \pm 25%	470	400	0.40	0.50	
	BLM21BD471SN1D BLM21BD471SN1B	470 \pm 25%	470	300	0.35	0.45	
	BLM21BD601SN1D BLM21BD601SN1B	600 \pm 25%	600	300	0.35	0.45	
	BLM21BD751SN1D BLM21BD751SN1B	750 \pm 25%	750	250	0.4	0.5	
	BLM21BD102SN1D BLM21BD102SN1B	1000 \pm 25%	1000	250	0.4	0.5	
	BLM21BD152SN1D BLM21BD152SN1B	1500 \pm 25%	1500	250	0.45	0.55	
	BLM21BD182SN1D BLM21BD182SN1B	1800 \pm 25%	1800	250	0.5	0.6	
	BLM21BD222SN1L BLM21BD222SN1B	1600 min.	2250	250	0.6	0.7	
	BLM21BD222TN1D BLM21BD222TN1B	2200 \pm 25%	2200	200	0.6	0.7	
	BLM21BD272SN1L BLM21BD272SN1B	2700 \pm 25%	2700	200	0.8	0.9	

Customer Part Number	MURATA Part Number	Impedance (Ω) (at 100MHz, Under Standard Testing Condition)		Rated Current (mA)	DC Resistance (Ω) max.		Remark
		Typical			Initial Values	Values After Testing	
	BLM21AG121SN1D	120±25%	120	1000	0.09	0.19	For general use
	BLM21AG121SN1B						
	BLM21AG151SN1D	150±25%	150	1000	0.09	0.19	
	BLM21AG151SN1B						
	BLM21AG221SN1D	220±25%	220	900	0.12	0.22	
	BLM21AG221SN1B						
	BLM21AG331SN1D	330±25%	330	800	0.15	0.25	
	BLM21AG331SN1B						
	BLM21AG471SN1D	470±25%	470	700	0.18	0.28	
	BLM21AG471SN1B						
	BLM21AG601SN1D	600±25%	600	700	0.2	0.3	
	BLM21AG601SN1B						
	BLM21AG102SN1D	1000±25%	1000	600	0.27	0.37	
	BLM21AG102SN1B						

- Operating Temperature : -55°C to +125°C
- Storage Temperature : -55°C to +125°C

(Note)As for Rated current marked with *1,
Rated Current is derated as right figure
depending on the operating temperature.

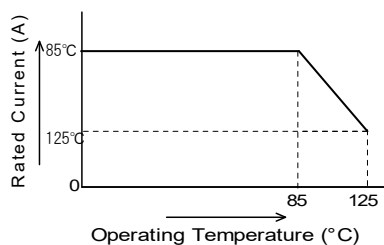

4. Style and Dimensions

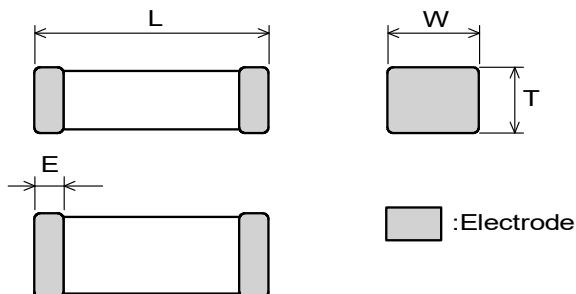

L	W	T	E
2.0±0.2	1.25±0.2	0.85±0.2	0.5±0.2
		for 21BD222SN1□ 21BD272SN1□ 1.25±0.2	

(in mm)

■ Equivalent Circuit

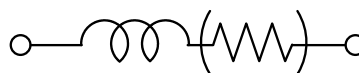

(Resistance element becomes dominant at high frequencies.)

■ Unit Mass (Typical value)

0.010g

0.014g (for 21BD222SN1□/21BD272SN1□)

5. Marking

No marking.

6. Standard Testing Conditions

< Unless otherwise specified >

Temperature : Ordinary Temp. (15 °C to 35 °C)
Humidity : Ordinary Humidity (25%(RH) to 85%(RH))

< In case of doubt >

Temperature : 20°C±2 °C
Humidity : 60%(RH) to 70%(RH)
Atmospheric pressure : 86kPa to 106kPa

7. Specifications

7-1. Electrical Performance

No.	Item	Specification	Test Method
7-1-1	Impedance	Meet item 3.	Measuring Frequency : 100MHz±1MHz Measuring Equipment : KEYSIGHT4291A or the equivalent Test Fixture : KEYSIGHT16192A or the equivalent
7-1-2	DC Resistance	Meet item 3.	Measuring Equipment : Digital multi meter * Except resistance of the Substrate and Wire

7-2. Mechanical Performance

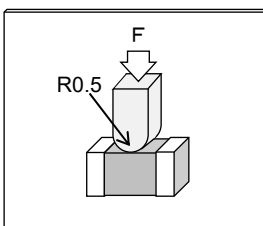
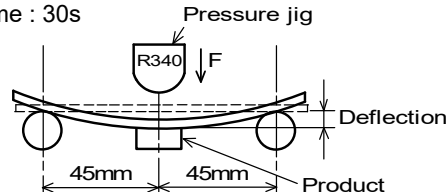
No.	Item	Specification	Test Method			
7-2-1	Appearance and Dimensions	Meet item 4.	Visual Inspection and measured with Slide Calipers.			
7-2-2	Bonding Strength	Meet Table 1.	It shall be soldered on the substrate. Applying Force(F) : 9.8N Applying Time : 5s±1s Applied direction:Parallel to substrate 			
		<table border="1"> <caption>Table 1</caption> <tr> <td>Appearance</td> <td>No damage</td> </tr> <tr> <td>Impedance Change (at 100MHz)</td> <td>Within ±30%</td> </tr> <tr> <td>DC Resistance</td> <td>Meet item 3.</td> </tr> </table>		Appearance	No damage	Impedance Change (at 100MHz)
Appearance	No damage					
Impedance Change (at 100MHz)	Within ±30%					
DC Resistance	Meet item 3.					
7-2-3	Bending Strength		It shall be soldered on the substrate. Substrate: Glass-epoxy 100mm×40mm×1.6mm Deflection: 1.0mm Speed of Applying Force : 0.5mm/s Keeping Time : 30s 			
7-2-4	Vibration		It shall be soldered on the substrate. Oscillation Frequency : 10Hz to 55Hz to 10Hz for 1 min Total Amplitude : 1.5mm Testing Time : A period of 2 hours in each of 3 mutually perpendicular directions. (Total 6 h)			
7-2-5	Resistance to Soldering Heat	Meet Table 2.	Pre-Heating : 150°C±10°C, 60s~90s Solder : Sn-3.0Ag-0.5Cu Solder Temperature : 270°C±5°C Immersion Time : 10s±0.5s Immersion and emersion rates : 25mm/s Then measured after exposure in the room condition for 48h±4h.			
		<table border="1"> <caption>Table 2</caption> <tr> <td>Appearance</td> <td>No damage</td> </tr> <tr> <td>Impedance Change (at 100MHz)</td> <td>Within ±30% (for BLM21SN) Within ±50%</td> </tr> <tr> <td>DC Resistance</td> <td>Meet item 3.</td> </tr> </table>		Appearance	No damage	Impedance Change (at 100MHz)
Appearance	No damage					
Impedance Change (at 100MHz)	Within ±30% (for BLM21SN) Within ±50%					
DC Resistance	Meet item 3.					
7-2-6	Drop	Products shall be no failure after tested.	It shall be dropped on concrete or steel board. Method : free fall Height : 75cm Attitude from which the product is dropped : 3 direction The number of times : 3 times for each direction(Total 9 times)			
7-2-7	Solderability	The electrodes shall be at least 95% covered with new solder coating.	Flux : Ethanol solution of rosin,25(wt)% Pre-Heating : 150°C±10°C, 60s~90s Solder : Sn-3.0Ag-0.5Cu Solder Temperature : 240°C±5°C Immersion Time : 4s±1s Immersion and emersion rates : 25mm/s			

7-3. Environmental Performance

It shall be soldered on the substrate.

No.	Item	Specification	Test Method
7-3-1	Temperature Cycle	Meet Table 2.	1 cycle : 1 step : -55 °C(+0 °C,-3 °C) / 30min±3min 2 step : Ordinary temp. / 10min to 15min 3 step : +125 °C(+3 °C,-0 °C) / 30min±3min 4 step : Ordinary temp. / 10min to 15min Total of 100 cycles Then measured after exposure in the room condition for 48h±4h.
7-3-2	Humidity		Temperature : 40°C±2°C Humidity : 90%(RH) to 95%(RH) Time : 1000h(+48h,-0h) Then measured after exposure in the room condition for 48h±4h.
7-3-3	Heat Life		Temperature : 125°C±3°C (in case of Rated current is more than 1A, do the test at : +85 °C±3°C) Applying Current : Rated Current Time : 1000h(+48h,-0h) Then measured after exposure in the room condition for 48h±4h.
7-3-4	Cold Resistance		Temperature : -55°C±2°C Time : 1000h(+48h,-0h) Then measured after exposure in the room condition for 48h±4h.

8. Specification of Packaging

8-1. Appearance and Dimensions

Part Number	Type	Appearance and Dimensions	
		a	
BLM21 except (21BD222SN1L 21BD272SN1L)	8mm-wide Paper tape	1.1 max.	<p style="text-align: center;">*Dimension of the Cavity is measured at the bottom side.</p>
BLM21BD222SN1L BLM21BD272SN1L	8mm-wide Plastic tape	1.3 ±0.1	

(in mm)

	Paper tape	Plastic tape
Taping	Products shall be packaged in the cavity of the base tape of 8mm-wide, 4mm-pitch continuously and sealed by top tape and bottom tape.	Products shall be packaged in the each embossed cavity of 8mm-wide, 4mm-pitch plastic tape continuously and sealed by cover tape.
Sprocket hole	The sprocket holes are to the right as the tape is pulled toward the user.	
Spliced point	The base tape and top tape have no spliced point.	The cover tape has no spliced point.
Cavity	There shall not be burr in the cavity.	—
Missing components number	Missing components number within 0.025% of the number per reel or 1 pc., whichever is greater, and are not continuous. The specified quantity per reel is kept.	

8-4. Specification of Outer Case

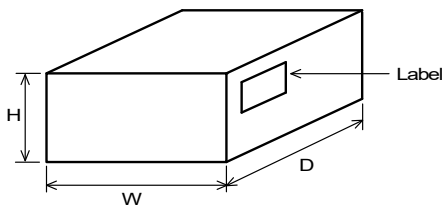

Outer Case Dimensions (mm)			Standard Reel Quantity in Outer Case (Reel)
W	D	H	
186	186	93	5

* Above Outer Case size is typical. It depends on a quantity of an order.

9. **Caution**

9-1. Surge current

Excessive surge current (pulse current or rush current) than specified rated current applied to the product may cause a critical failure, such as an open circuit, burnout caused by excessive temperature rise.

Please contact us in advance in case of applying the surge current.

9-2. Limitation of Applications

Please contact us before using our products for the applications listed below which require especially high reliability for the prevention of defects which might directly cause damage to the third party's life, body or property.

- | | |
|-----------------------------------|--|
| (1) Aircraft equipment | (6) Disaster prevention / crime prevention equipment |
| (2) Aerospace equipment | (7) Traffic signal equipment |
| (3) Undersea equipment | (8) Transportation equipment (trains,ships,etc.) |
| (4) Power plant control equipment | (9) Data-processing equipment |
| (5) Medical equipment | (10) Applications of similar complexity and /or reliability requirements to the applications listed in the above |

10. Notice

This product is designed for solder mounting.

Please consult us in advance for applying other mounting method such as conductive adhesive.

10-1. Land pattern designing

- Standard land dimensions
- < BLM21 series(except BLM21PG/BLM21S type) >

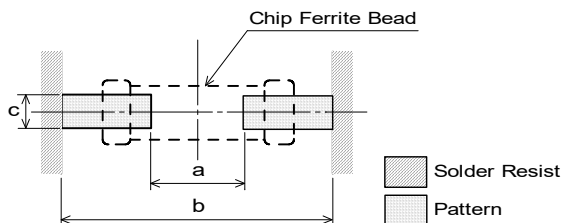

Soldering	a	b	c
Flow	1.1	3.5	0.95
Reflow	1.2	2.4	1.25

(in mm)

< For BLM21PG/BLM21S type >

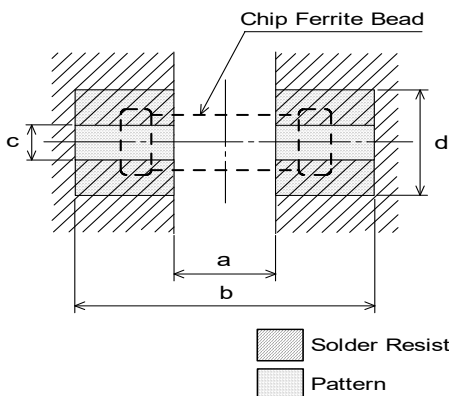

Type	Rated Current (A)	Land pad thickness and dimension d		
		18μm	35μm	70μm
BLM21PG	1.5	1.25	1.25	1.25
	2	1.25	1.25	1.25
	3~4	2.4	1.25	1.25
	6	6.4	3.3	1.65
BLM21S	1~8.5	-	6.8	3.4

(in mm)

Soldering	a	b	c
Flow	1.1	3.5	0.95
Reflow	1.2	2.4	1.25

(in mm)

*The excessive heat by land pads may cause deterioration at joint of products with substrate.

10-2. Soldering Conditions

Products can be applied to reflow and flow soldering.

(1) Flux, Solder

Flux	Use rosin-based flux, but not highly acidic flux (with chlorine content exceeding 0.2(wt)%.) Do not use water-soluble flux.
Solder	Use Sn-3.0Ag-0.5Cu solder Standard thickness of solder paste : 100 μm to 200 μm

(2) Soldering conditions

- Pre-heating should be in such a way that the temperature difference between solder and ferrite surface is limited to 150°C max. Also cooling into solvent after soldering should be in such a way that the temperature difference is limited to 100°C max.

Insufficient pre-heating may cause cracks on the ferrite, resulting in the deterioration of product quality.

- Standard soldering profile and the limit soldering profile is as follows.

The excessive limit soldering conditions may cause leaching of the electrode and / or resulting in the deterioration of product quality.

(3) soldering profile

□Flow soldering profile

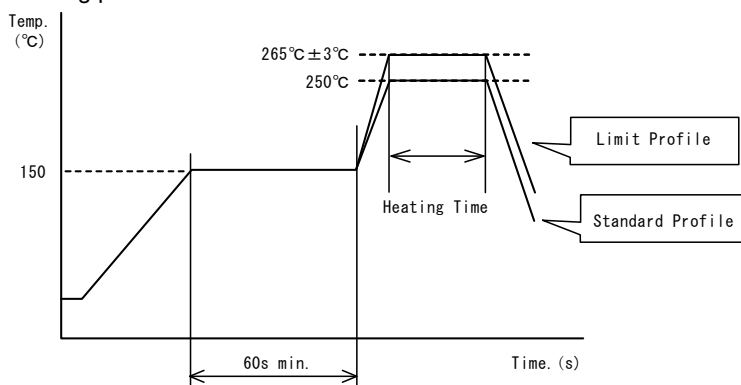

	Standard Profile	Limit Profile
Pre-heating	150°C、60s min.	
Heating	250°C、4~6s	265°C ± 3°C、5s max.
Cycle of flow	2 times	2 times

□Reflow soldering profile

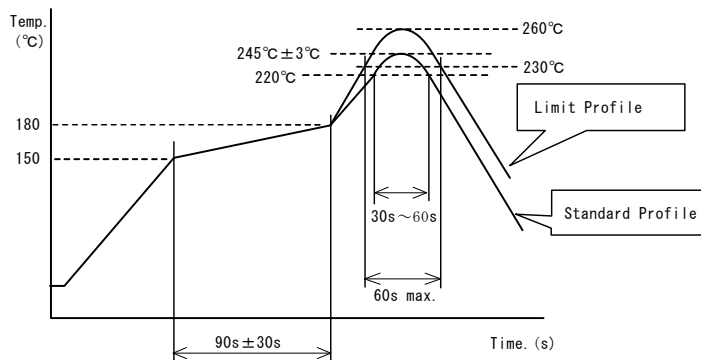

	Standard Profile	Limit Profile
Pre-heating	150~180°C、90s ± 30s	
Heating	above 220°C、30s~60s	above 230°C、60s max.
Peak temperature	245 ± 3°C	260°C、10s
Cycle of reflow	2 times	2 times

10-3. Reworking with soldering iron

- Pre-heating: 150°C, 1 min
- Tip temperature: 350°C max.
- Soldering time : 3(+1,-0) seconds.
- Soldering iron output: 80W max.
- Tip diameter: φ 3mm max.
- Times : 2times max.

Note :Do not directly touch the products with the tip of the soldering iron in order to prevent the crack on the ferrite material due to the thermal shock.

10-4. Solder Volume

Solder shall be used not to be exceed as shown below.

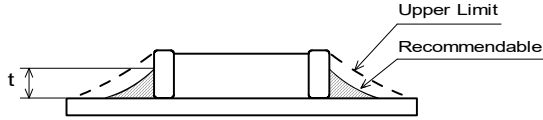

$$1/3T \leq t \leq T$$

(T:Chip thickness)

Accordingly increasing the solder volume, the mechanical stress to product is also increased. Exceeding solder volume may cause the failure of mechanical or electrical performance.

10-5. Attention regarding P.C.B. bending

The following shall be considered when designing and laying out P.C.B.'s.

- (1) P.C.B. shall be designed so that products are not subjected to the mechanical stress for board warpage.

<Products direction>

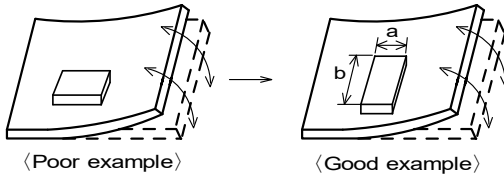

Products shall be located in the sideways direction (Length:a<b) to the mechanical stress.

- (2) Components location on P.C.B. separation.

It is effective to implement the following measures, to reduce stress in separating the board. It is best to implement all of the following three measures; however, implement as many measures as possible to reduce stress.

Contents of Measures	Stress Level
(1) Turn the mounting direction of the component parallel to the board separation surface.	A > D *1
(2) Add slits in the board separation part.	A > B
(3) Keep the mounting position of the component away from the board separation surface.	A > C

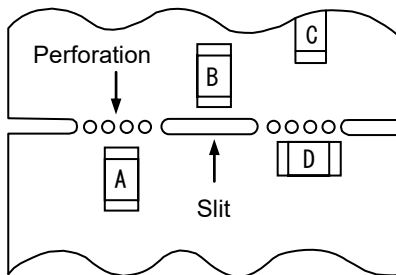

*1 A > D is valid when stress is added vertically to the perforation as with Hand Separation. If a Cutting Disc is used, stress will be diagonal to the PCB, therefore A > D is invalid.

- (3) Mounting Components Near Screw Holes

When a component is mounted near a screw hole, it may be affected by the board deflection that occurs during the tightening of the screw. Mount the component in a position as far away from the screw holes as possible.

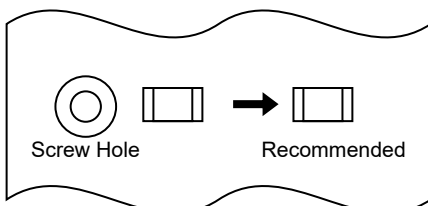

10-6. Mounting density

Add special attention to radiating heat of products when mounting the inductor near the products with heating. The excessive heat by other products may cause deterioration at joint of this product with substrate.

10-7. Operating Environment

Do not use this product under the following environmental conditions, on deterioration of the Insulation Resistance of the Ferrite material and/or corrosion of Inner Electrode may result from the use.

- (1) in the corrodible atmosphere such as acidic gases, alkaline gases, chlorine, sulfur gases, organic gases and etc (the sea breeze, Cl₂, H₂S, NH₃, SO₂, NO₂, etc)
- (2) in the atmosphere where liquid such as organic solvent, may splash on the products.
- (3) in the atmosphere where the temperature / humidity changes rapidly and it is easy to dew.

10-8. Resin coating

The impedance value may change and/or it may affect on the product's performance due to high cure-stress of resin to be used for coating / molding products. So please pay your careful attention when you select resin. In prior to use, please make the reliability evaluation with the product mounted in your application set.

10-9. Cleaning

Excessive ultrasonic oscillation during cleaning can cause the PCBs to resonate, resulting in cracked chips or broken solder joints. Before starting your production process, test your cleaning equipment / process to insure it does not degrade this product.

10-10. Handling of a substrate

After mounting products on a substrate, do not apply any stress to the product caused by bending or twisting to the substrate when cropping the substrate, inserting and removing a connector from the substrate or tightening screw to the substrate.

Excessive mechanical stress may cause cracking in the product.

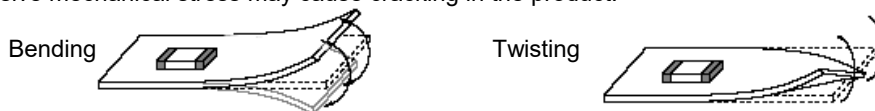

10-11 Storage Conditions

(1) Storage period

Use the products within 6 months after delivered.
Solderability should be checked if this period is exceeded.

(2) Storage conditions

- Products should be stored in the warehouse on the following conditions.
 - Temperature : -10°C to 40°C
 - Humidity : 15% to 85% relative humidity
 - No rapid change on temperature and humidity
- Don't keep products in corrosive gases such as sulfur, chlorine gas or acid, or it may cause oxidization of electrode, resulting in poor solderability.
- Products should be stored on the palette for the prevention of the influence from humidity, dust and so on.
- Products should be stored in the warehouse without heat shock, vibration, direct sunlight and so on.
- Avoid storing the product by itself bare (i.e.exposed directly to air).

(3) Delivery

Care should be taken when transporting or handling product to avoid excessive vibration or mechanical shock.

11. Note

- (1) Please make sure that your product has been evaluated in view of your specifications with our product being mounted to your product.
- (2) You are requested not to use our product deviating from the agreed specifications.
- (3) The contents of this reference specification are subject to change without advance notice. Please approve our product specifications or transact the approval sheet for product specifications before ordering.