



ON Semiconductor®

<http://onsemi.com>

# PCP1403

## N-Channel Power MOSFET 60V, 4.5A, 117mΩ, Single PCP

### Features

- On-resistance  $R_{DS(on)1}=92m\Omega$ (typ.)
- 4V drive
- Protection Diode in
- Halogen free compliance

### Specifications

#### Absolute Maximum Ratings at $T_a = 25^\circ\text{C}$

Parameter	Symbol	Conditions	Value	Unit
Drain to Source Voltage	$V_{DSS}$		60	V
Gate to Source Voltage	$V_{GSS}$		$\pm 20$	V
Drain Current (DC)	$I_D$		4.5	A
Drain Current (Pulse)	$I_{DP}$	$PW \leq 10\mu s$ , duty cycles $\leq 1\%$	18	A
Power Dissipation	$P_D$	$T_c = 25^\circ\text{C}$	3.5	W
		When mounted on ceramic substrate (600mm <sup>2</sup> ×0.8mm)	1.3	W
Junction Temperature	$T_j$		150	$^\circ\text{C}$
Storage Temperature	$T_{stg}$		- 55 to +150	$^\circ\text{C}$

Stresses exceeding those listed in the Maximum Ratings table may damage the device. If any of these limits are exceeded, device functionality should not be assumed, damage may occur and reliability may be affected.

### Thermal Resistance Ratings

Parameter	Symbol	Value	Unit
Junction to Case Steady State	$R_{\theta JC}$	35.7	$^\circ\text{C}/\text{W}$
Junction to Ambient When mounted on ceramic substrate (600mm <sup>2</sup> ×0.8mm)	$R_{\theta JA}$	96.1	$^\circ\text{C}/\text{W}$

### Electrical Characteristics at $T_a = 25^\circ\text{C}$

Parameter	Symbol	Conditions	Value			Unit
			min	typ	max	
Drain to Source Breakdown Voltage	$V_{(BR)DSS}$	$I_D=1\text{mA}$ , $V_{GS}=0\text{V}$	60			V
Zero-Gate Voltage Drain Current	$I_{DSS}$	$V_{DS}=60\text{V}$ , $V_{GS}=0\text{V}$			1	$\mu\text{A}$
Gate to Source Leakage Current	$I_{GSS}$	$V_{GS}=\pm 16\text{V}$ , $V_{DS}=0\text{V}$			$\pm 10$	$\mu\text{A}$
Gate Threshold Voltage	$V_{GS(th)}$	$V_{DS}=10\text{V}$ , $I_D=1\text{mA}$	1.2		2.6	V
Forward Transconductance	$g_{FS}$	$V_{DS}=10\text{V}$ , $I_D=2\text{A}$		2.5		S
Static Drain to Source On-State Resistance	$R_{DS(on)1}$	$I_D=2\text{A}$ , $V_{GS}=10\text{V}$		92	117	$m\Omega$
	$R_{DS(on)2}$	$I_D=1\text{A}$ , $V_{GS}=4.5\text{V}$		120	168	$m\Omega$
	$R_{DS(on)3}$	$I_D=1\text{A}$ , $V_{GS}=4\text{V}$		132	185	$m\Omega$
Input Capacitance	$C_{iss}$	$V_{DS}=20\text{V}$ , $f=1\text{MHz}$		310		pF
Output Capacitance	$C_{oss}$			40		pF
Reverse Transfer Capacitance	$C_{rss}$			25		pF

Continued on next page.

### ORDERING INFORMATION

See detailed ordering and shipping information on page 2 of this data sheet.

# PCP1403

Continued from preceding page.

Parameter	Symbol	Conditions	Value			Unit
			min	typ	max	
Turn-ON Delay Time	$t_{d(on)}$	See specified Test Circuit		5.6		ns
Rise Time	$t_r$			7.0		ns
Turn-OFF Delay Time	$t_{d(off)}$			26		ns
Fall Time	$t_f$			14		ns
Total Gate Charge	$Q_g$	$V_{DS}=30V, V_{GS}=10V, I_D=4.5A$		6.7		nC
Gate to Source Charge	$Q_{gs}$			1.0		nC
Gate to Drain "Miller" Charge	$Q_{gd}$			1.6		nC
Forward Diode Voltage	$V_{SD}$	$I_S=4.5A, V_{GS}=0V$		0.88	1.2	V

Product parametric performance is indicated in the Electrical Characteristics for the listed test conditions, unless otherwise noted. Product performance may not be indicated by the Electrical Characteristics if operated under different conditions.

## Ordering & Package Information

Device	Package	Shipping	note
PCP1403-TD-H	PCP, SC-62 SOT-89, TO-243	1,000 pcs. / reel	Pb-Free and Halogen Free

## Packing Type:TD

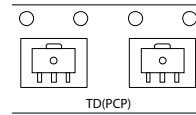

## Marking

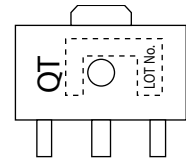

## Electrical Connection

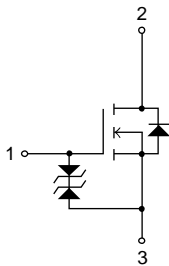

## Switching Time Test Circuit

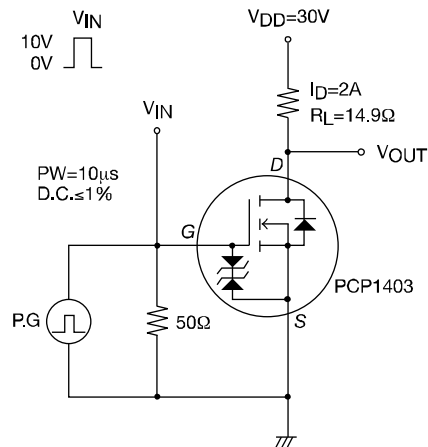

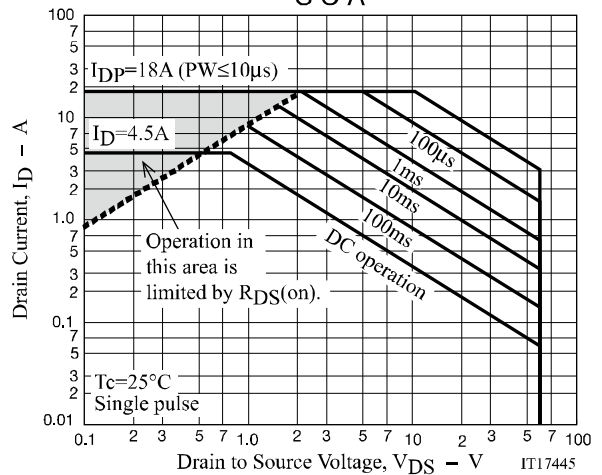
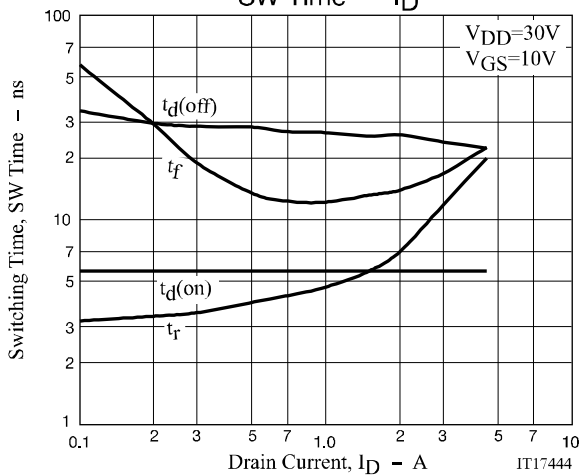
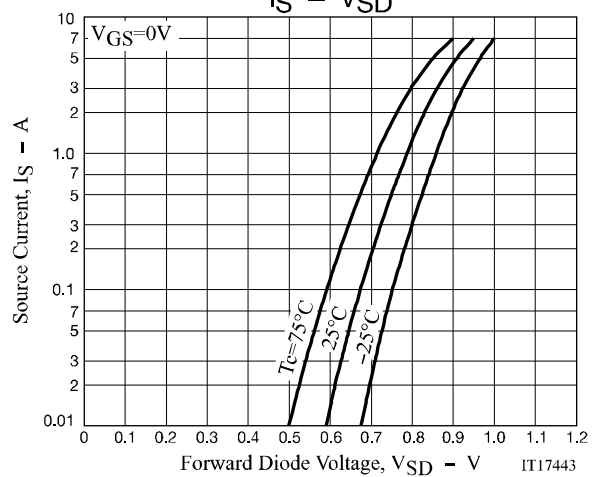
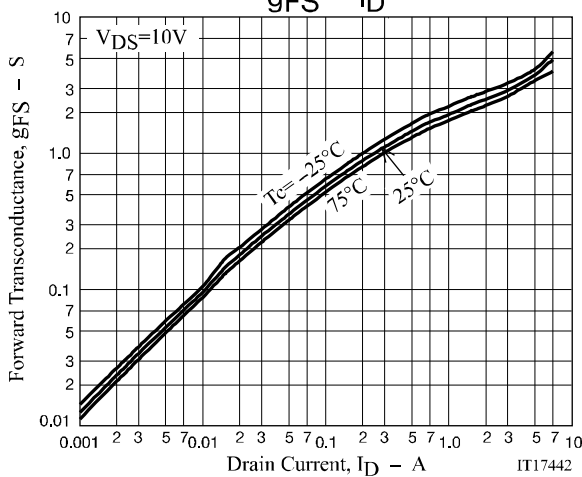
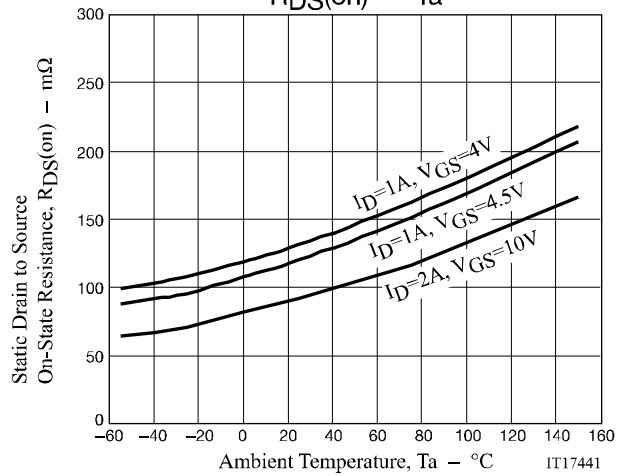
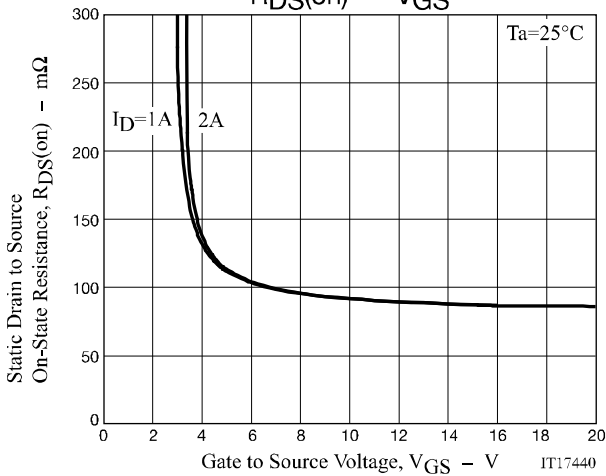
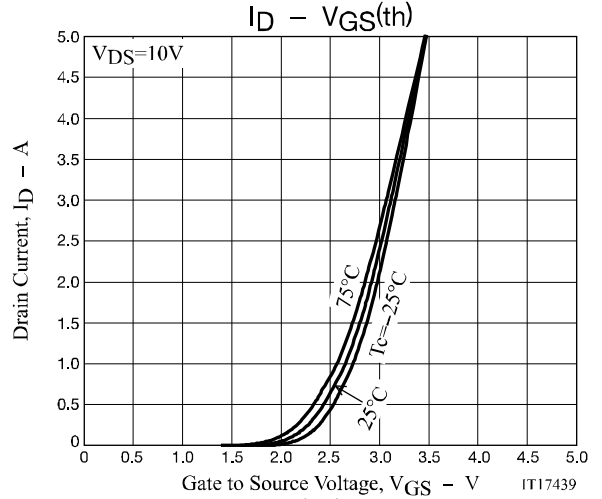
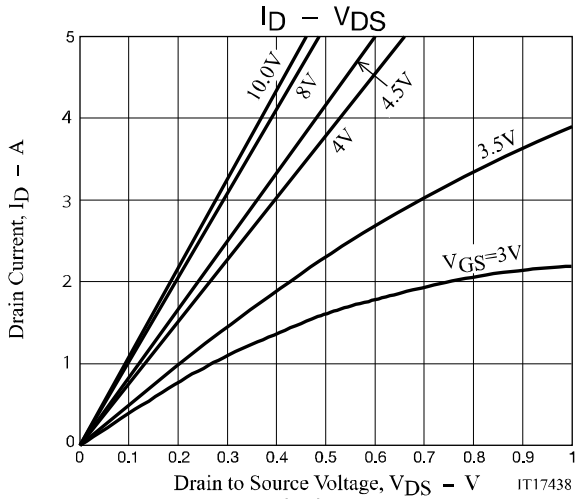

# PCP1403

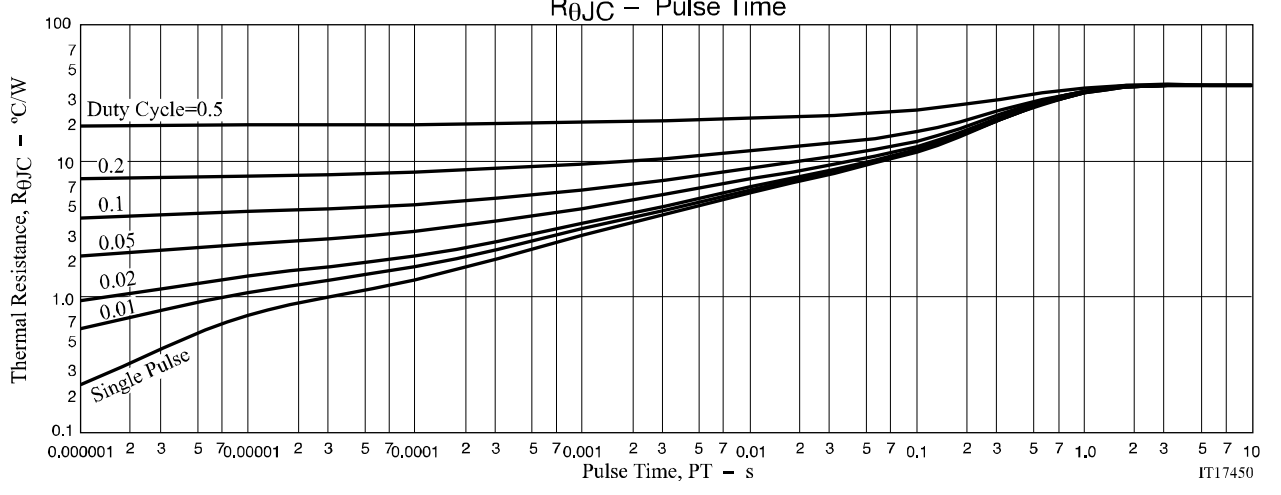
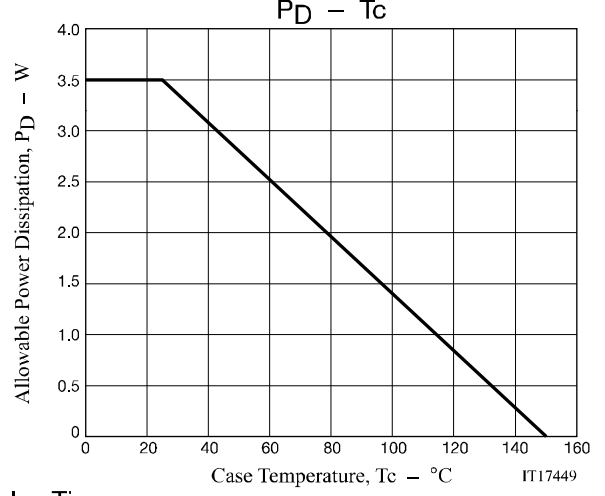
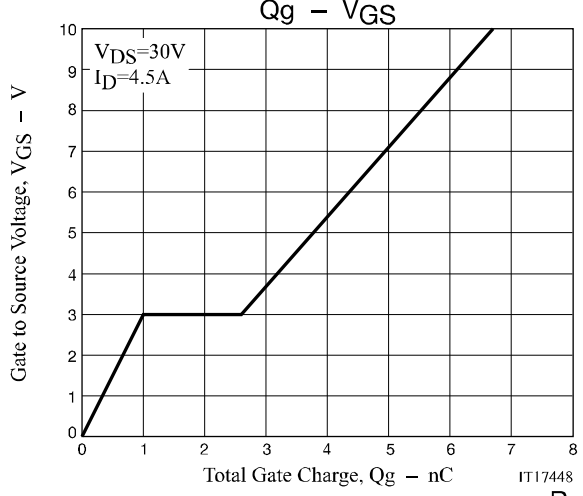
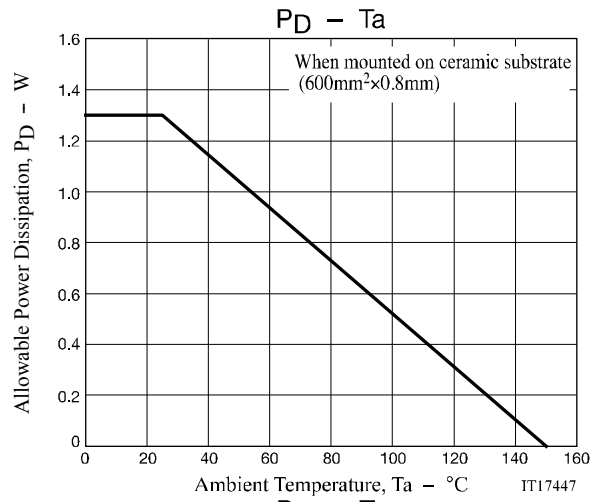
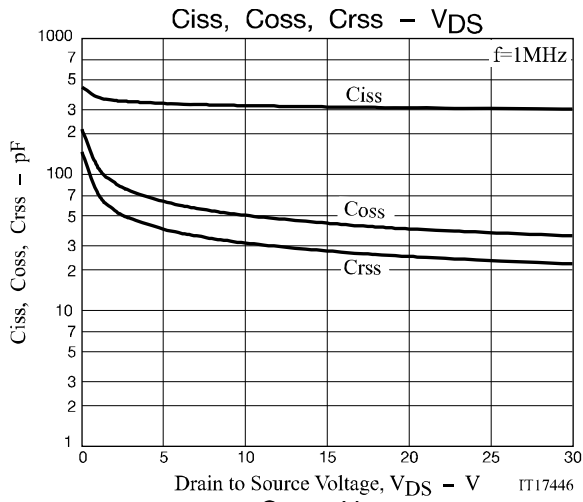

# PCP1403

## Package Dimensions

PCP1403-TD-H

### SOT-89/PCP-1

CASE 419AU

ISSUE O

Unit : mm

1: Gate

2: Drain

3: Source

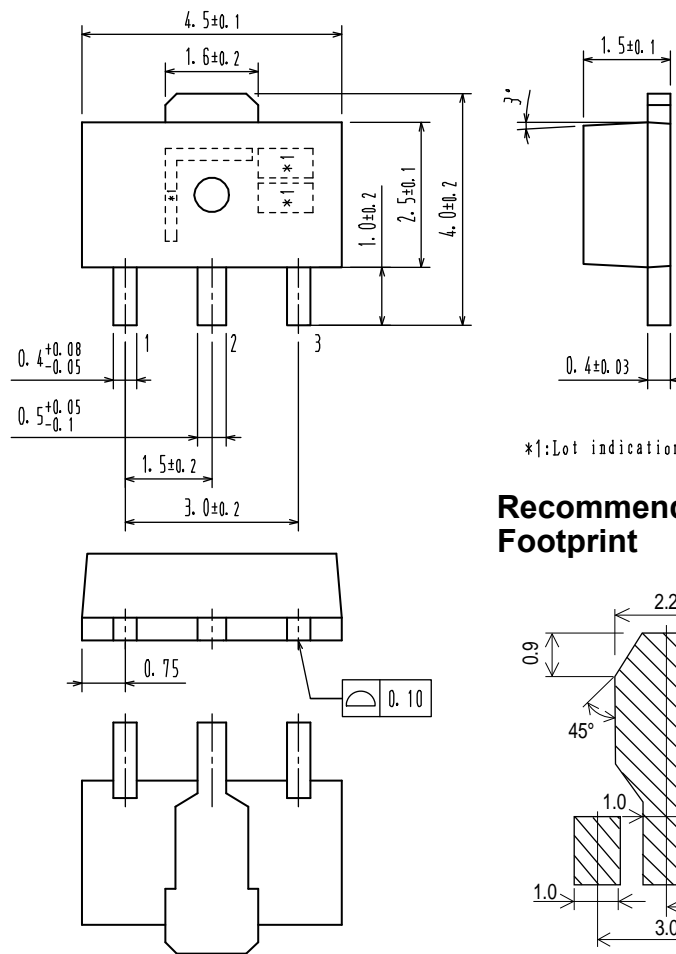

\*1: Lot indication

### Recommended Soldering Footprint

Note on usage : Since the PCP1403 is a MOSFET product, please avoid using this device in the vicinity of highly charged objects.

ON Semiconductor and the ON logo are registered trademarks of Semiconductor Components Industries, LLC (SCILLC). SCILLC owns the rights to a number of patents, trademarks, copyrights, trade secrets, and other intellectual property. A listing of SCILLC's product/patent coverage may be accessed at [www.onsemi.com/site/pdf/Patent-Marking.pdf](http://www.onsemi.com/site/pdf/Patent-Marking.pdf). SCILLC reserves the right to make changes without further notice to any products herein. SCILLC makes no warranty, representation or guarantee regarding the suitability of its products for any particular purpose, nor does SCILLC assume any liability arising out of the application or use of any product or circuit, and specifically disclaims any and all liability, including without limitation special, consequential or incidental damages. "Typical" parameters which may be provided in SCILLC data sheets and/or specifications can and do vary in different applications and actual performance may vary over time. All operating parameters, including "Typicals" must be validated for each customer application by customer's technical experts. SCILLC does not convey any license under its patent rights nor the rights of others. SCILLC products are not designed, intended, or authorized for use as components in systems intended for surgical implant into the body, or other applications intended to support or sustain life, or for any other application in which the failure of the SCILLC product could create a situation where personal injury or death may occur. Should Buyer purchase or use SCILLC products for any such unintended or unauthorized application, Buyer shall indemnify and hold SCILLC and its officers, employees, subsidiaries, affiliates, and distributors harmless against all claims, costs, damages, and expenses, and reasonable attorney fees arising out of, directly or indirectly, any claim of personal injury or death associated with such unintended or unauthorized use, even if such claim alleges that SCILLC was negligent regarding the design or manufacture of the part. SCILLC is an Equal Opportunity/Affirmative Action Employer. This literature is subject to all applicable copyright laws and is not for resale in any manner.