

842/892 SERIES



High Temp Card Edge Connectors 0.100" (2.54mm) Pitch

Features:

- 0.100" (2.54mm) contact spacing x 0.200" (5.08mm) row spacing
- Accepts 0.062" (1.57mm) nominal thickness P.C. board
- High profile insulator body, 0.590" (14.99mm)
- Contact termination options include P.C. tail, wire wrap, 90 degree bends and extender board bends
- Single or dual row configurations
- Variety of mounting options, flush or offset lugs
- Accepts in-contact polarizing keys
- RoHS Compliant & UL Certified

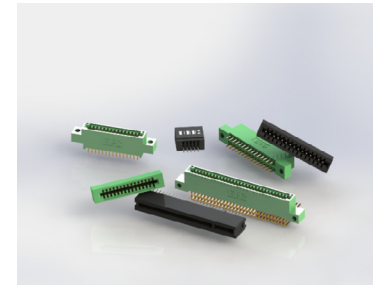

Specifications:

Insulator Material	(842: Diallyl Phthalate) (892: Polyphenylene sulfide) , UL 94V-0
Contact Material	Copper Alloy
Contact Plating	Gold Plating on mating area and Tin Plating on tails with Nickel underplating all over
Current Rating	3 amps
Contact Resistance	10 milliohms maximum
Dielectric Withstanding Voltage	1200 V AC rms at sea level between adjacent contacts
Insulation Resistance	5000 megaohms minimum
Operating Temperature	-40°C to +125°C
Insertion Force	16 oz (4.45 N) maximum per contact pair when tested with .070" (1.78mm) thick gauge
Withdrawal Force	1 oz (0.28 N) minimum per contact pair when tested with .054" (1.37mm) thick gauge

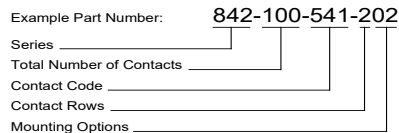

Series:	Insulator Color:	Contact Code:	Tail Description:	Tail Size:	Tail Length "G":
842	Green	500	Wire Hole	.050 x .025 (1.27 x 0.64)	.270 (6.86)
892	Black	520	P.C. Tail	.030 x .018 (0.76 x 0.46)	.185 (4.70)
Total Number of Contacts:	Contact Rows:	521	P.C. Tail	.025 Square (0.64 Square)	.160 (4.06)
005, 006, 058	Single Row	523	P.C. Tail	.025 Square (0.64 Square)	.400 (10.16)
010, 012, 116	Dual Row	524	P.C. Tail	.018 Square (0.46 Square)	.185 (4.70)
Contact Rows:	Description:	540	Wire Wrap	.025 Square (0.64 Square)	.570 (14.48)
1	Single Row	541	Wire Wrap	.025 Square (0.64 Square)	.760 (19.30)
2	Dual Row	542	Wire Wrap	.025 Square (0.64 Square)	.655 (16.64)
Mounting Options:	Description:	544	Wire Wrap	.050 x .025 (1.27 x 0.64)	.760 (19.30)
01	No Mounting Lug	555	EXTENDER BOARD BEND	(CODE 500 CONTACTS)	
02	Ø.128" (Ø3.25mm) Mounting Holes	556	EXTENDER BOARD BEND	(CODE 520 CONTACTS)	
03	Ø.116" (Ø2.95mm) I.D. Floating Eyelets	558	90 DEGREE BEND	(CODE 541 CONTACTS)	
04	Ø.156" (Ø3.96mm) Mounting Holes	559	90 DEGREE BEND	CODE 541 CONTACTS)	
07	M3-0.5 Metric Threaded Inserts	560	EXTENDER BOARD BEND	CODE 523 CONTACTS)	
08	#4-40 Unified Threaded Inserts				
12	Ø.128" (Ø3.25mm) Side Mounting Holes				

**IN-CONTACT
POLARIZING KEY**
P/N 345-240-328

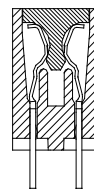

Ordering Code Notes:

- 1) All connector sizes up to 58 contacts single row / 116 contacts dual row are available upon request.
- 2) For details of the extender board and 90 degree bends refer to next pages.
- 3) For details of the mounting options refer to page 3.

842/892 SERIES



High Temp Card Edge Connectors 0.100" (2.54mm) Pitch

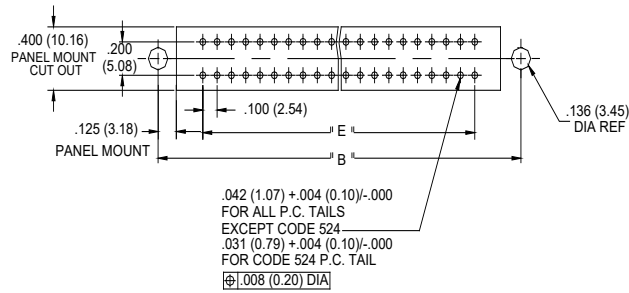
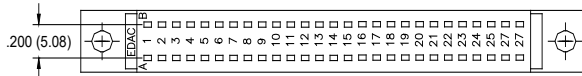
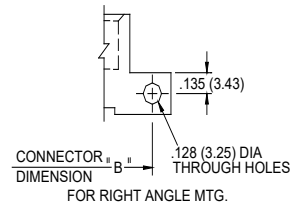
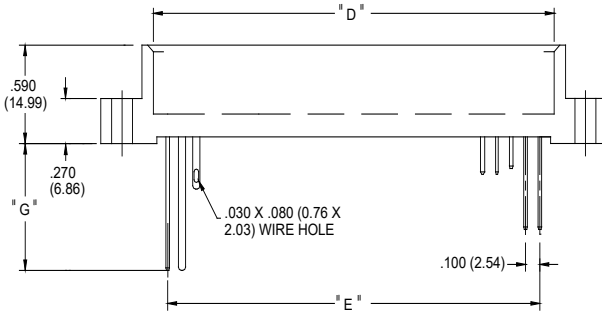
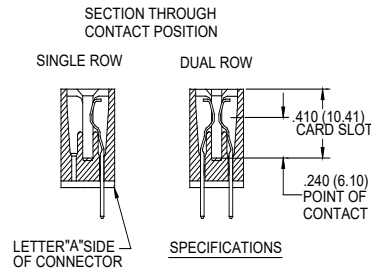
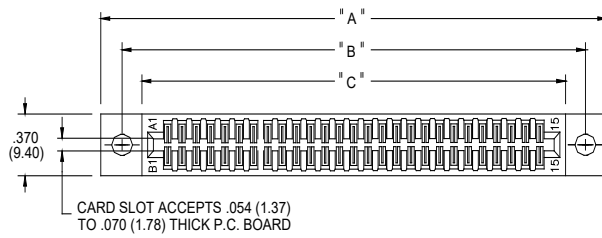

CONNECTOR MOUNTING PATTERN

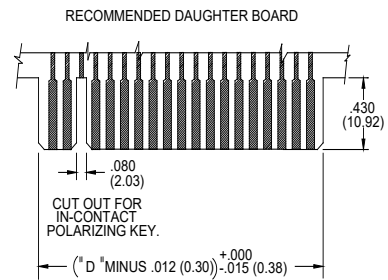

NUMBER OF CONTACTS		"A"		"B"		"C"		"D"		"E"	
Single	Double	Inch	mm	Inch	mm	Inch	mm	Inch	mm	Inch	mm
5	10	1.300	33.02	1.022	25.96	0.746	18.95	0.600	15.24	0.400	10.16
10	20	1.800	45.72	1.522	38.66	1.246	31.65	1.100	27.94	0.900	22.86
15	30	2.100	53.34	1.822	46.28	1.546	39.27	1.400	35.56	1.200	30.48
13	26	2.300	58.42	2.022	51.36	1.746	44.35	1.600	40.64	1.400	35.56
18	36	2.600	66.04	2.322	58.98	2.046	51.97	1.900	48.26	1.700	43.18
22	44	3.000	76.20	2.722	69.14	2.446	62.13	2.300	58.42	2.100	53.34
25	50	3.300	83.82	3.022	76.76	2.746	69.75	2.600	66.04	2.400	60.96
30	60	3.800	96.52	3.522	89.46	3.246	82.45	3.100	78.74	2.900	73.66
31	62	3.900	99.06	3.622	92.00	3.346	84.99	3.200	81.28	3.000	76.20
35	70	4.300	109.22	4.022	102.16	3.746	95.15	3.600	91.44	3.400	86.36
36	72	4.400	111.76	4.122	104.70	3.846	97.69	3.700	93.98	3.500	88.90
43	86	5.100	129.54	4.822	122.48	4.546	115.47	4.400	111.76	4.200	106.68
50	100	5.800	147.32	5.522	140.26	5.246	133.25	5.100	129.54	4.900	124.46
58	116	6.600	167.64	6.322	160.58	6.046	153.57	5.900	149.86	5.700	144.78

842/892 SERIES



High Temp Card Edge Connectors 0.100" (2.54mm) Pitch

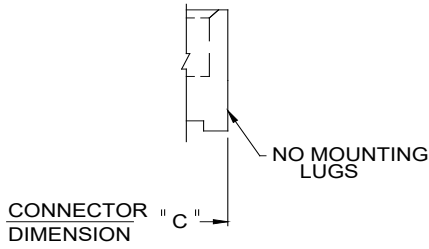

MOUNTING OPTION
CODE x01

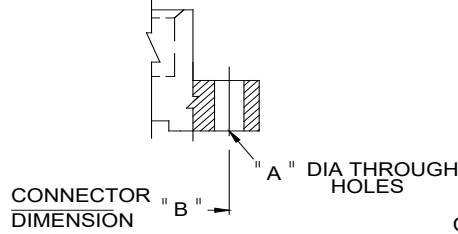

MOUNTING OPTION
CODES x02 and x04

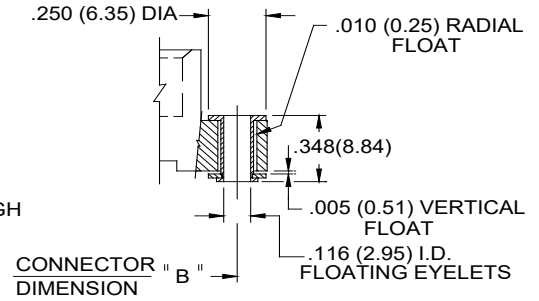

MOUNTING OPTION
CODE x03

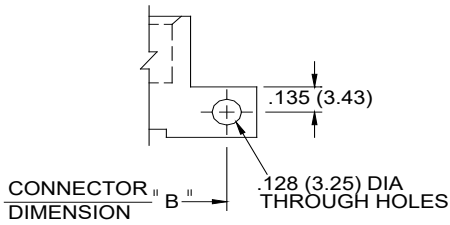

FOR RIGHT ANGLE MTG.
CODE X12

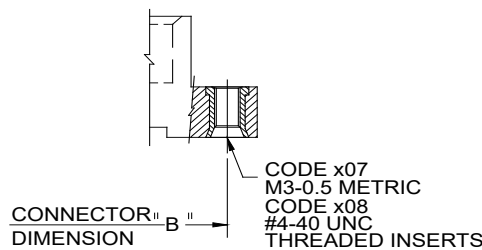

MOUNTING OPTION
CODES x07 & x08

CODE X02 AND X04- THROUGH MTG. HOLES		
	CODE X02	CODE X04
"A" DIA.	0.128(3.25)X 0.146(3.71) SLOT	0.156(3.96)
CODE X07 AND X08- THREADED INSERTS		
	CODE X07	CODE X08
INSERT	M3-0.5(METRIC)	#4-40 UNC
SIDE MOUNTING HOLES WITH INSERTS		
	CODE X17	CODE X18
INSERT	M3-0.5(METRIC)	#4-40 UNC

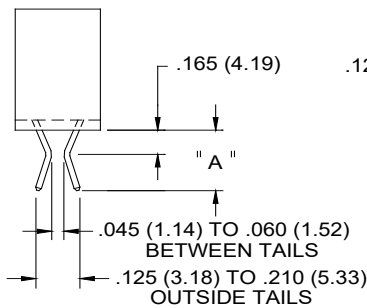

CONTACT CODE 560

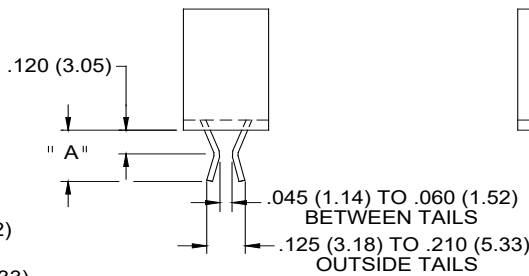

CONTACT CODE 555
BEND USES WIRE HOLE CONTACTS

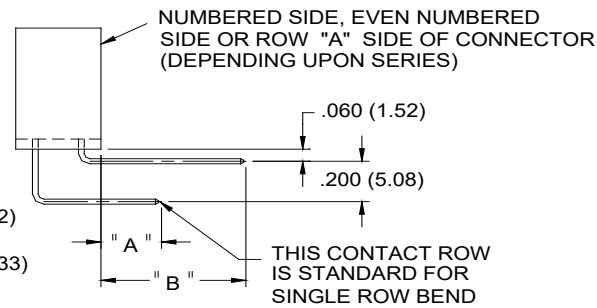

CONTACT CODE 558

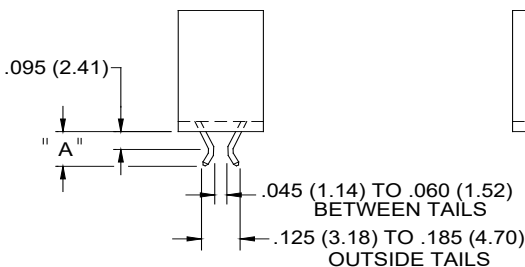

CONTACT CODE 556

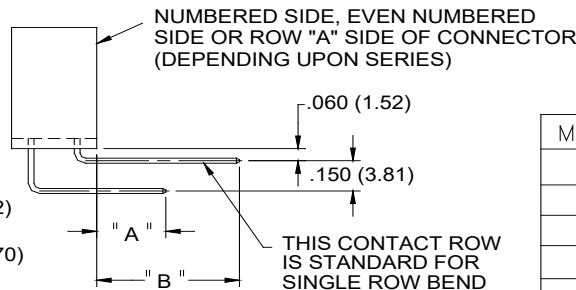

CONTACT CODE 559

MTG. OPTION	A	B
555	0.255(6.48)	
556	0.180(4.57)	
558	0.245(6.22)	0.645(16.38)
559	0.295(7.49)	0.645(16.38)
560	0.385(9.78)	