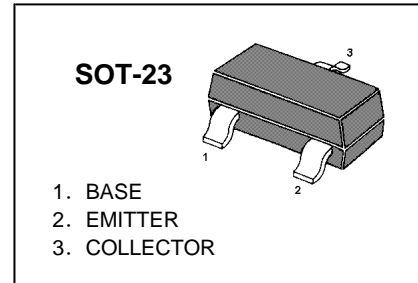

**SS8550 TRANSISTOR (PNP)**
**FEATURES**

Complimentary to SS8050

**MARKING: Y2**

**MAXIMUM RATINGS (T<sub>A</sub>=25°C unless otherwise noted)**

Symbol	Parameter	Value	Units
V <sub>CB0</sub>	Collector-Base Voltage	-40	V
V <sub>CE0</sub>	Collector-Emitter Voltage	-25	V
V <sub>EBO</sub>	Emitter-Base Voltage	-5	V
I <sub>C</sub>	Collector Current -Continuous	-1.5	A
P <sub>C</sub>	Collector Power Dissipation	0.3	W
T <sub>J</sub>	Junction Temperature	150	°C
T <sub>stg</sub>	Storage Temperature	-55-150	°C

**ELECTRICAL CHARACTERISTICS (T<sub>amb</sub>=25°C unless otherwise specified)**

Parameter	Symbol	Test conditions	MIN	MAX	UNIT
Collector-base breakdown voltage	V <sub>(BR)CBO</sub>	I <sub>C</sub> =-100μA, I <sub>E</sub> =0	-40		V
Collector-emitter breakdown voltage	V <sub>(BR)CEO</sub>	I <sub>C</sub> =-0.1mA, I <sub>B</sub> =0	-25		V
Emitter-base breakdown voltage	V <sub>(BR)EBO</sub>	I <sub>E</sub> =-100μA, I <sub>C</sub> =0	-5		V
Collector cut-off current	I <sub>CBO</sub>	V <sub>CB</sub> =-40V, I <sub>E</sub> =0		-0.1	μA
Collector cut-off current	I <sub>CEO</sub>	V <sub>CE</sub> =-20V, I <sub>B</sub> =0		-0.1	μA
Emitter cut-off current	I <sub>EBO</sub>	V <sub>EB</sub> =-5V, I <sub>C</sub> =0		-0.1	μA
DC current gain	h <sub>FE(1)</sub>	V <sub>CE</sub> =-1V, I <sub>C</sub> =-100mA	200	350	
	h <sub>FE(2)</sub>	V <sub>CE</sub> =-1V, I <sub>C</sub> =-800mA	40		
Collector-emitter saturation voltage	V <sub>CE(sat)</sub>	I <sub>C</sub> =-800mA, I <sub>B</sub> =-80mA		-0.5	V
Base-emitter saturation voltage	V <sub>BE(sat)</sub>	I <sub>C</sub> =-800mA, I <sub>B</sub> =-80mA		-1.2	V
Base-emitter on voltage	V <sub>BE(on)</sub>	I <sub>C</sub> =-1V, V <sub>CE</sub> =-10mA		-1	V
Base-emitter positive favor voltage	V <sub>BEF</sub>	I <sub>B</sub> =-1A		-1.55	V
Transition frequency	f <sub>T</sub>	V <sub>CE</sub> = -10V, I <sub>C</sub> = -50mA f=30MHz	100		MHz
output capacitance	C <sub>ob</sub>	(V <sub>CB</sub> =-10V, I <sub>E</sub> =0, f=1MHz)		20	pF

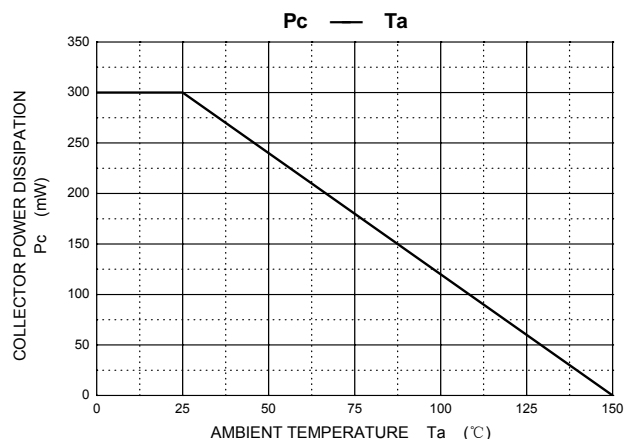
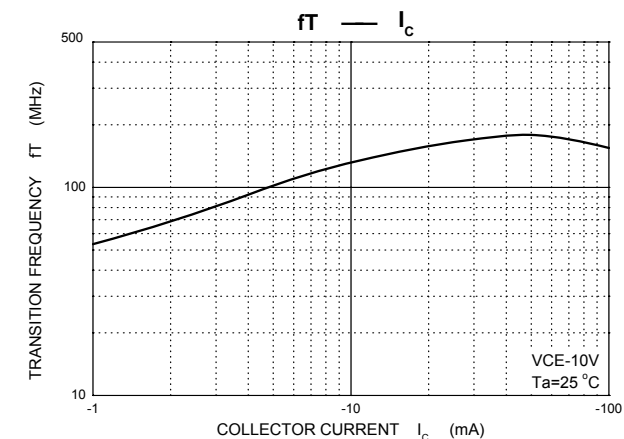
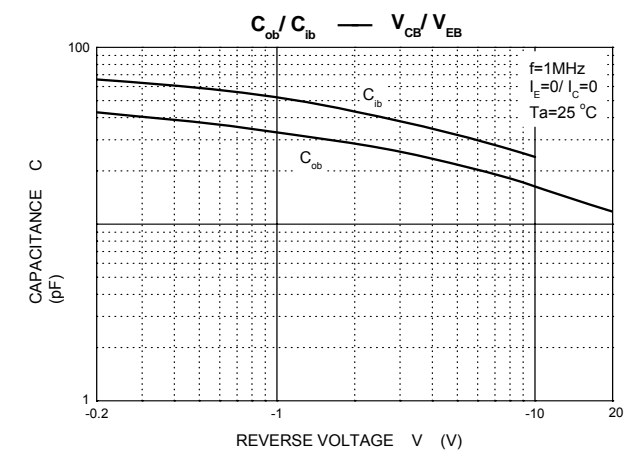
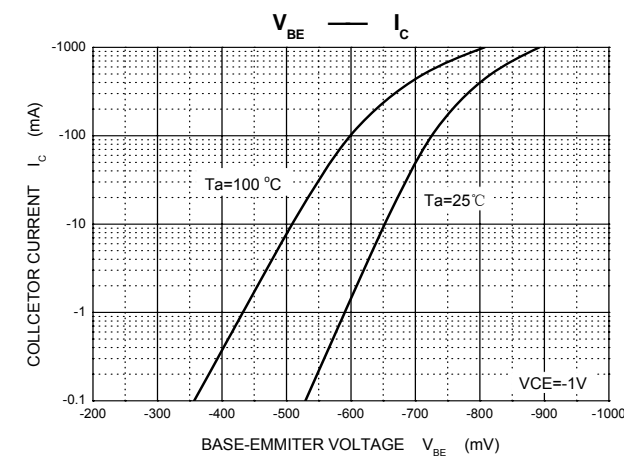
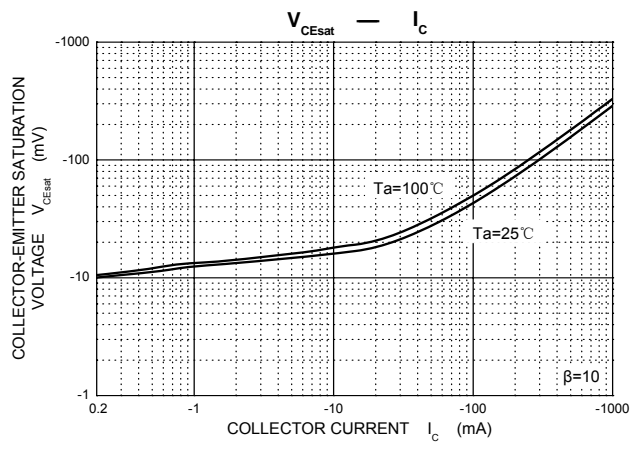
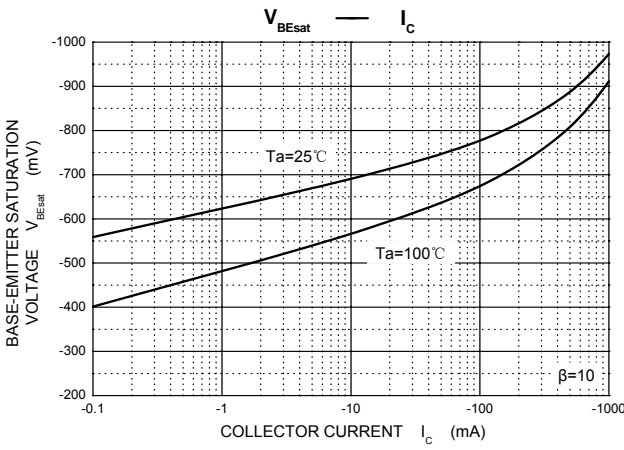
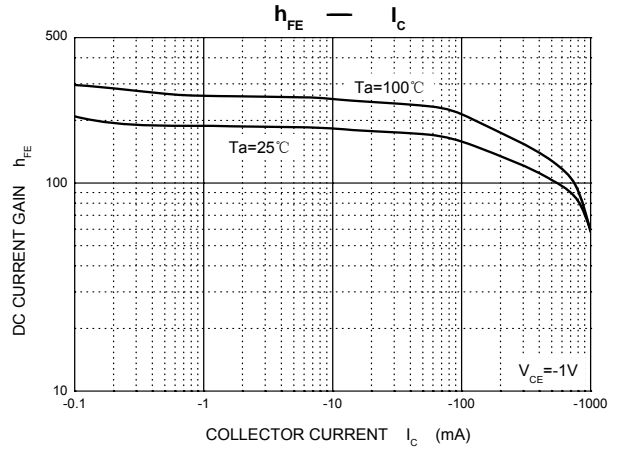
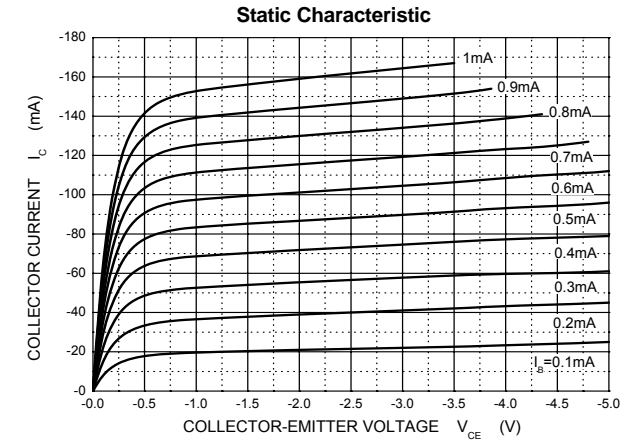
Typical Characteristics



PACKAGE OUTLINE

Plastic surface mounted package; 3 leads

SOT-23

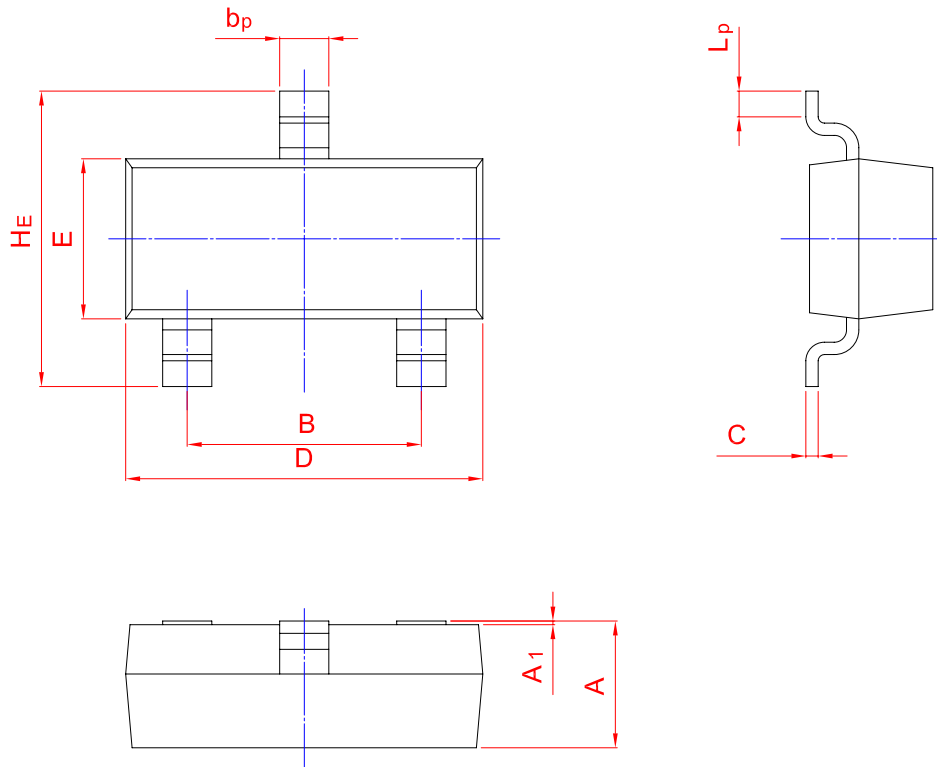
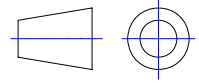

UNIT	A	B	bp	C	D	E	HE	A1	Lp
mm	1.40 0.95	2.04 1.78	0.50 0.35	0.19 0.08	3.10 2.70	1.65 1.20	3.00 2.20	0.100 0.013	0.50 0.20