

2mm Pitch Miniature Connector for HDD

A3E Series

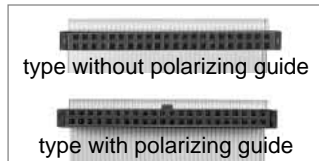
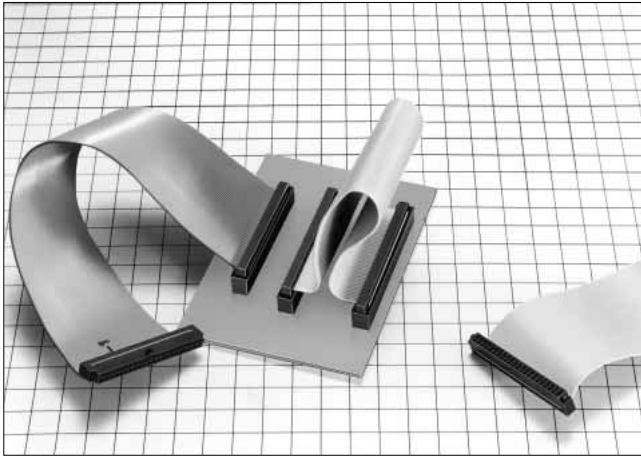

■Features

1. Variation in Number of Contacts

This connector can be chosen according to applications, using together with other series products as follows:

- (1) Cable crimping type (A3B series)
- (2) Cable ID type (A3E series)
- (3) FFC connection type (MA18 series, A3C series)

(However, the A3E series pin header corresponds to the A3E series socket only.)

On the other hand, 44 contacts are available for AT bus connection, and 55 contacts for SCSI connection.

2. Batch Insulation Displacement

1 mm pitch ribbon cable can be insulated and displaced.

3. Mechanism to Prevent Mis-insertion

The connector on the socket side contains a mechanism to prevent mis-insertion in the connector on the header side.

■Product Specifications

Rating	Current rating: 0.5A	Operating Temperature Range:-55 to +85°C (Note 1)	Storage Temperature Range:-10 to +60°C (Note 2)
	Voltage rating: 125V AC	Operating Moisture Range:40 to 80%	Storage Humidity Range:40 to 70% (Note 2)

Item	Specification	Condition
1. Insulation Resistance	1000M ohms min.	250V DC
2. Withstanding voltage	No flashover or insulation breakdown.	300V AC/1 minute
3. Contact Resistance	40m ohms max.	0.1A
4. Vibration	No electrical discontinuity of 1 μ s or more	Frequency: 10 to 55 Hz, single amplitude of 0.75 mm, 2 hours in each of the 3 directions.
5. Humidity (Steady state)	Insulation resistance: 1000M ohms min.	96 hours at temperature of 40°C and humidity of 90% to 95%
6. Temperature Cycle	No damage, cracks, or parts looseness.	(-55°C: 30 minutes →15 to 35°C: 5 minutes max.→ +85°C: 30 minutes →15 to 35°C: 5 minutes max.) 5 cycles
7. Durability (Mating/un-mating)	Contact resistance: 50m ohms max.	100 cycles
8. Resistance to Soldering heat	No deformation of components affecting performance.	Solder bath: 260°C for 10 seconds
		Manual soldering: 350°C for 3 seconds

Note 1: Includes temperature rise caused by current flow.

Note 2: The term "storage" refers to products stored for long period of time prior to mounting and use. Operating Temperature Range and Humidity range covers non conducting condition of installed connectors in storage, shipment or during transportation.

Note 3: Information contained in this catalog represents general requirements for this Series. Contact us for the drawings and specifications for a specific part number shown.

■Material

Part		Material	Finish	Remarks
Insulator	Pin header	Polyamid	Black	UL94V-0
	Socket	PBT		
Contact	Pin header	Brass	Selective gold plated over nickel underplated	—
	Socket	Beryllium copper		

■ Ordering Information

● Pin Header

A3E - * P A - 2 DSA
 ① ② ③ ④ ⑤ ⑥

① Series Name	: A3E
② Number of contacts:	44, 50
③ P:	Pin header
④ A:	Selective gold plated
⑤ Contact pitch :	2mm
⑥ Contact type:	DSA : Straight dip type

● Socket

A3E - * D - 2 R
 ① ② ③ ④ ⑤

① Series Name	: A3E : With polarizing guide A3EA : Without polarizing guide
② Number of contacts:	44, 50
③ D:	Receptacle
④ Contact pitch:	2mm
⑤ Connection type:	R : ID type

Pin Header

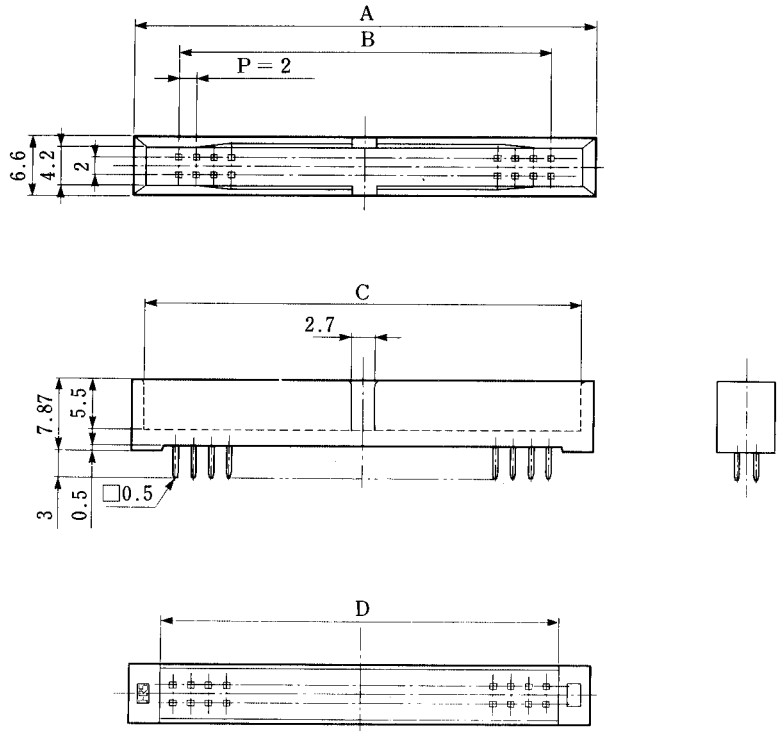
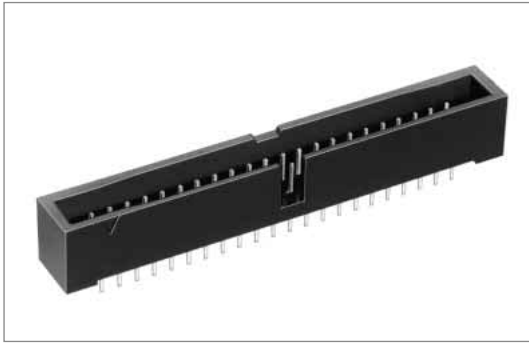

PCB mounting pattern

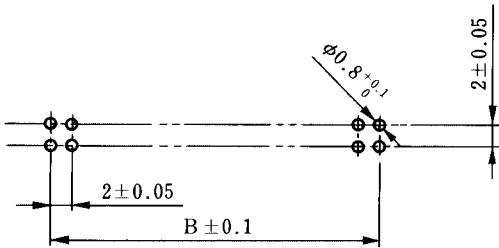

Unit: mm

Part Number	CL No.	A	B	C	D	RoHS
A3E-44PA-2DSA(71)	621-0911-8-71	52.0	42.0	49.2	45.0	YES
A3E-50PA-2DSA(71)	621-0914-6-71	58.0	48.0	55.2	51.0	

● For 44 pos., without contact No. 20 pin header is available. A3E-44PA-2DSA(81)

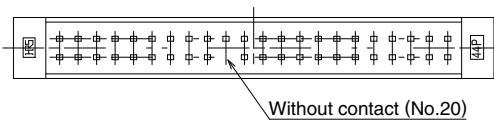
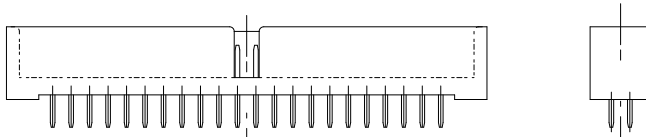
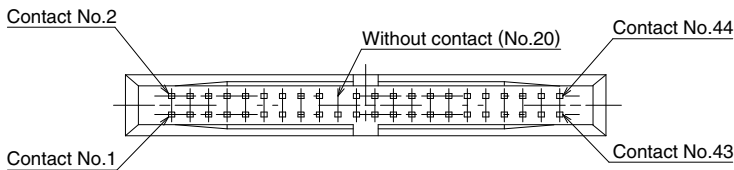

Socket

● Type with polarizing guide to prevent mis-insertion (A3E)

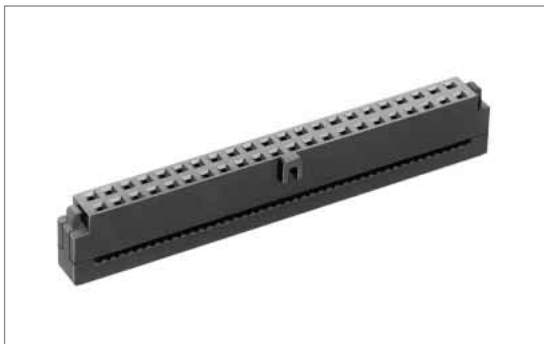

Body

Protector

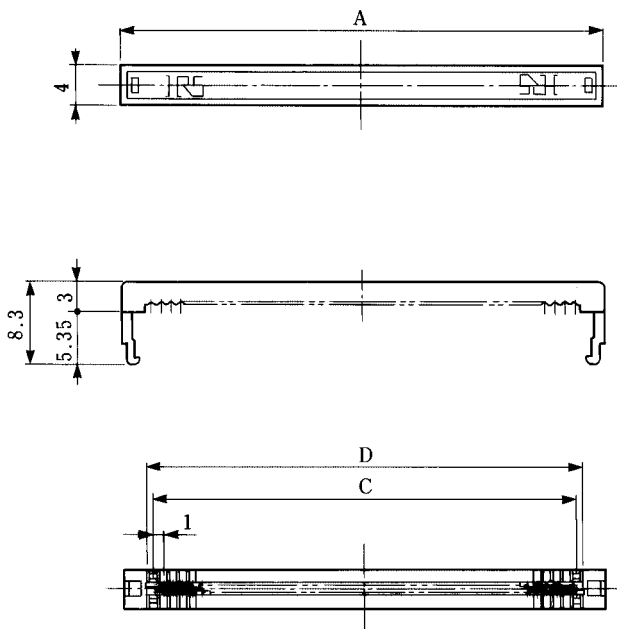
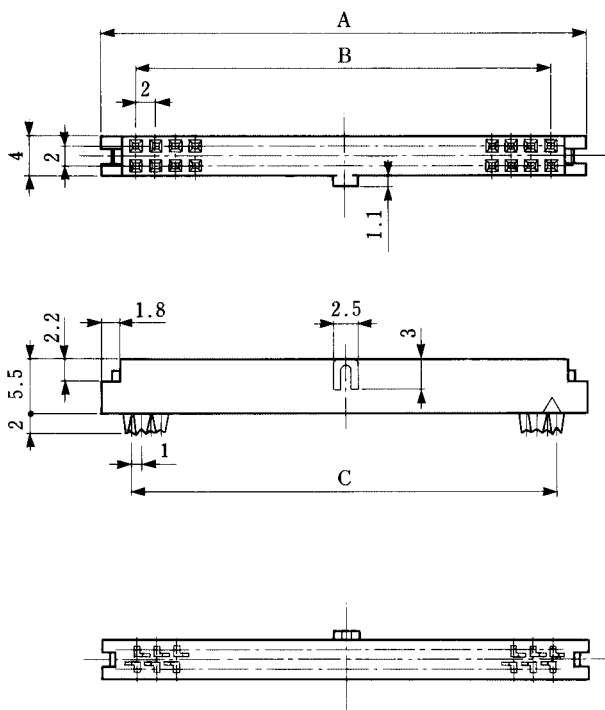

Combination View

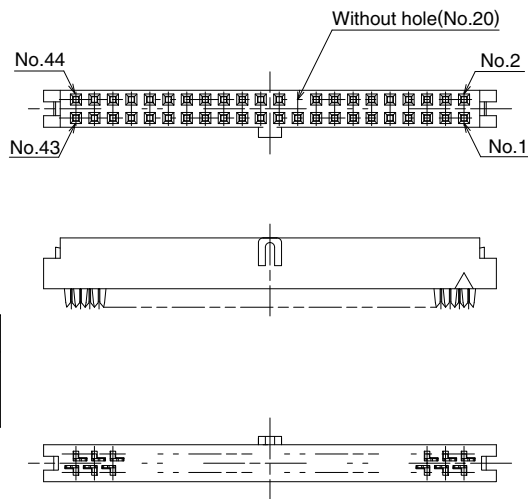
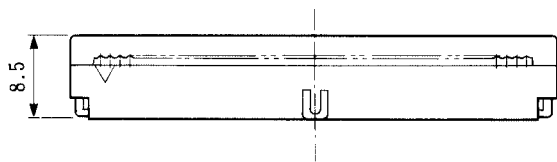

Unit: mm

Part Number	CL No.	A	B	C	D	RoHS
A3E-44D-2R	621-0811-3	49.0	42.0	43.0	44.3	YES
A3E-50D-2R	621-0814-1	55.0	48.0	49.0	50.3	

Note : For 44 pos., without contact No. 20 hole socket is available.

●Type without polarizing guide to prevent false-insertion (A3EA)

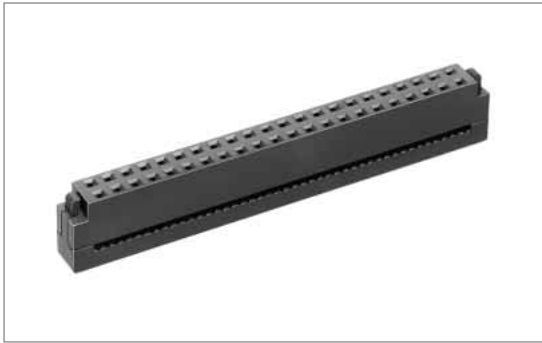

Body

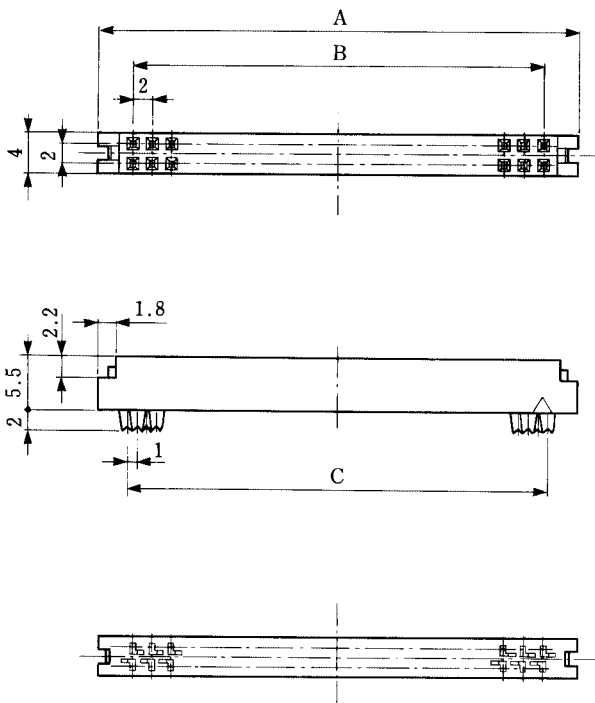

Protector

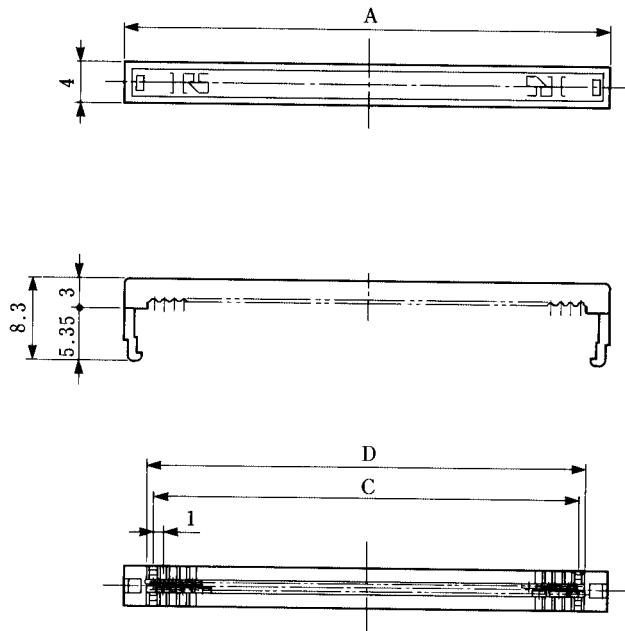

Combination View

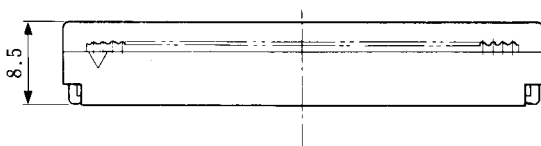

Unit: mm

Part Number	CL No.	A	B	C	D	RoHS
A3EA-44D-2R	621-0861-1	49.0	42.0	43.0	44.3	YES
A3EA-50D-2R	621-0864-0	55.0	48.0	49.0	50.3	

■Recommended Cable for A3E Socket

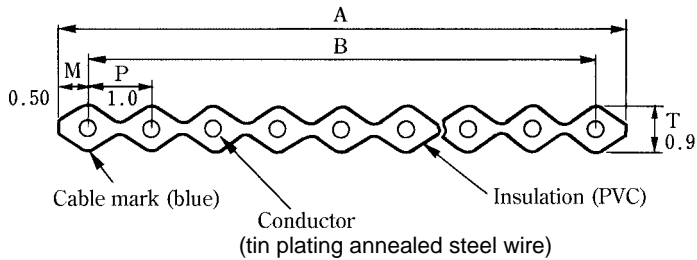

Ribbon Cable

Number of Contacts	Core wire Construction (pc./mm)	A	B
44	7/0.127	44	43
50	7/0.127	50	49

◆Table of A3E Series Connection Tools

●Connection Press



Part Number: HI-FLEX Connection Press HHP502
CL550-0082-2

●Pressing Block



Part Number: Pressing Block A-01
CL550-0133-1

●Applicator

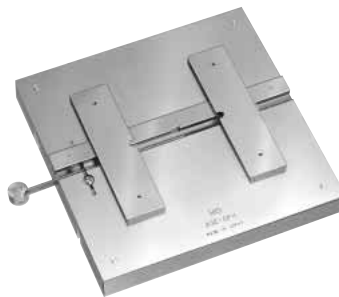

Universal Guide Plate
Part Number: A3E-GPA
CL550-0216-7

MA18 Series

The MA18 series is a 2mm pitch FFC socket connector developed for miniature HDD and main port connection. 44 contacts are provided for AT bus connection.

Ordering Information

MA18A - 44 D A - 2 DSA

① ② ③ ④ ⑤ ⑥

① Series Name : MA18A	⑥ Contact type (Straight type)
② Number of contacts : 44	DSA : Dip length 3mm
③ Contact alignment : D : Double row	DSB : Dip length 2.5mm
④ Contact plating type A : Selective gold plated	DSC : Dip length 2mm
⑤ Contact pitch : 2mm	

Variation in Number of Contacts

Part Number	CL No.	Remarks	RoHS
MA18A-44DA-2DSA(71)	588-0247-3-71	—	YES
MA18A-44DA-2DSB(71)	588-0255-1-71	—	
MA18A-44DA-2DSC(71)	588-0253-6-71	—	
MA18M-44DA-2DSB(71)	588-0291-5-71	High profile mount type	

Variation in Connection between HDD and Main Board

■ Pin Heade

(1) Conventional product (used as conventional HDD interface pin header)

- Straight through hole type (see catalog page C15)



44 contacts : A3C-44P-2DSA (see photo)
50 contacts : A3C-50P-2DSA

- Straight SMT type (see catalog page C22)

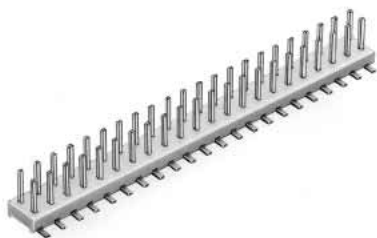

44 contacts : A3-44PA-2SV(71) (see photo)
50 contacts : A3-50PA-2SV(71)
(With boss type available)

- Right angle through hole type (see catalog page C13)



44 contacts : A3B-44PA-2DS(71) (see photo)
50 contacts : A3B-50PA-2DS(71)

(2) Box type product (Socket side prevents mis-insertion)

- Straight through hole type(see catalog page C28)

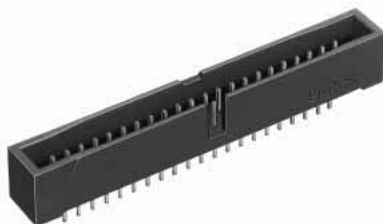

44 contacts : A3E-44PA-2DSA(71) (see photo)
50 contacts : A3E-50PA-2DSA(71)
Note: Correspond to A3E series socket only.

Socket

(1) Products suitable to various cables

- Discrete wire Crimping Type (see catalog page C19)



44 contacts: A3B-44D-2C
Crimping contacts and crimping tools are detailed on page C20.

- Ribbon Cable (1mm pitch) Batch ID Type (see catalog page C29)

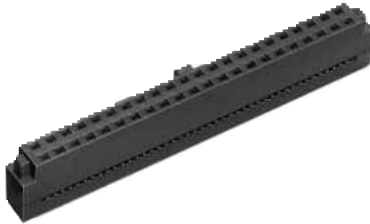

44 contacts: A3E-44D-2R (see photo)
50 contacts: A3E-50D-2R
Insulation displacement is detailed on page C31.

- FPC Connection Type



44 contacts: MA18A-44DA-2DSA(71) (photo)

(For a typical example, products are provided corresponding to various board thickness. For details, refer to page C32.)

50 contacts: A3C-50DA-2DSC(71)

(For a typical example, products are provided corresponding to various board thickness. For details, refer to page C17.)

(2) Right Angle through hole Type (see catalog page C16.)

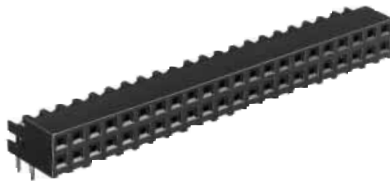

44 contacts: A3-44DA-2DS(71) (see photo)
50 contacts: A3-50DA-2DS(71)

(3) Straight through hole Type

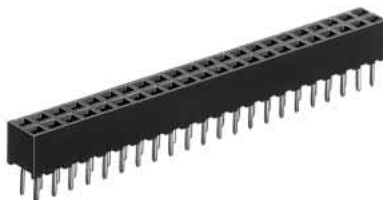

44 contacts: MA18A-44DA-2DSA(71) (see photo)
(See catalog page C32.)
50 contacts: A3C-50DA-2DSA(71) (see catalog page C17.)