

### 440A Series, 1206 High I<sup>2</sup>t Fuse

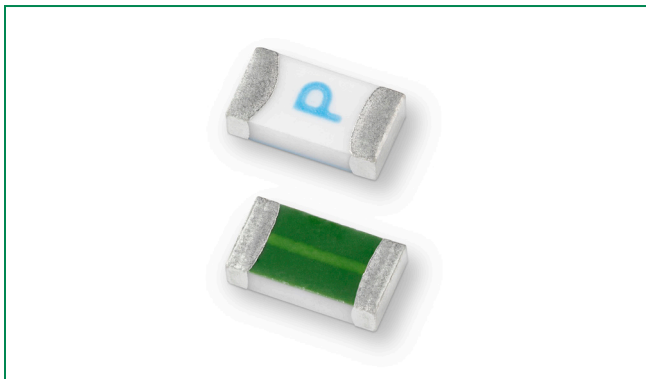

#### Description

The 440A Series AECQ-Compliant fuses are specifically tested to cater to secondary circuit protection needs of compact auto electronics applications.



The general design ensures excellent temperature stability and performance reliability. This high I<sup>2</sup>t fuse series is designed to have ultra high inrush current withstand capability to avoid nuisance fuse open.

#### Features

- Operating Temperature from -55°C to +150°C
- 100% Lead-free, RoHS compliant and Halogen-free
- Meets Littelfuse's automotive qualifications\*
- Ultra high I<sup>2</sup>t values
- Fast response to faulty current to ensure over-current protection to sensitive electronic component

\* - Largely based on Littelfuse internal AEC-Q200 test plan.

#### Agency Approvals

AGENCY	AGENCY FILE NUMBER	AMPERE RANGE
	E10480	0.500A - 8A
	29862	0.500A - 8A

#### Electrical Characteristics for Series

% of Ampere Rating	Ampere Rating	Opening Time at 25°C
100%	.50A - .75A 1.75A - 8A	4 hours, Minimum
350%	.50A - .75A 1.75A - 8A	5 secs., Maximum

#### Applications

- Li-ion Battery
- LED Lighting
- Automotive Navigation System
- TFT Display
- Battery Management System (BMS)
- Cluster

#### Additional Information



Datasheet





Resources



Samples

#### Electrical Specifications by Item

Ampere Rating (A)	Amp Code	Max. Voltage Rating (V)	Interrupting Rating (AC/DC) <sup>1</sup>	Nominal Resistance (Ohms) <sup>2</sup>	Nominal Melting I <sup>2</sup> t (A <sup>2</sup> Sec.) <sup>3</sup>	Nominal Voltage Drop At Rated Current (V) <sup>4</sup>	Nominal Power Dissipation At Rated Current (W)	Agency Approvals	
									
0.5	.500	63	50A @ 63VAC/DC	0.8140	0.02642	0.4831	0.242	x	X
0.75	.750	63	50A @ 63VAC/DC	0.4624	0.09312	0.3983	0.299	x	X
1.75	1.75	32	50A @ 32VAC/DC	0.0450	0.3312	0.0777	0.136	x	X
2	002.	32		0.0385	0.4326	0.0792	0.158	x	X
2.5	02.5	32		0.02850	0.8191	0.0747	0.187	x	X
3	003.	32		0.02252	1.232	0.0742	0.223	x	X
3.5	03.5	32		0.01845	1.789	0.0757	0.265	x	X
4	004.	32		0.01553	2.601	0.0709	0.284	x	X
5	005.	32		0.0120	4.761	0.0654	0.327	x	X
7	007.	32		0.00753	8.464	0.0696	0.487	x	X
8	008.	32	0.00634	12.95	0.0655	0.524	x	X	

#### Notes:

- AC Interrupting Rating tested at rated voltage with unity power factor. DC Interrupting Rating tested at rated voltage with time constant < 0.8 msec.
- Nominal Resistance measured with < 10% rated current.
- Nominal Melting I<sup>2</sup>t measured at 1msec. opening time.
- Nominal Voltage Drop measured at rated current after temperature has stabilized.

Devices designed to carry rated current for 4 hours minimum. It is recommended that devices be operated continuously at no more than 80% rated current. See "Temperature Derating Curve" for additional derating information.

Devices designed to be mounted with marking code facing up.

### Temperature Derating Curve

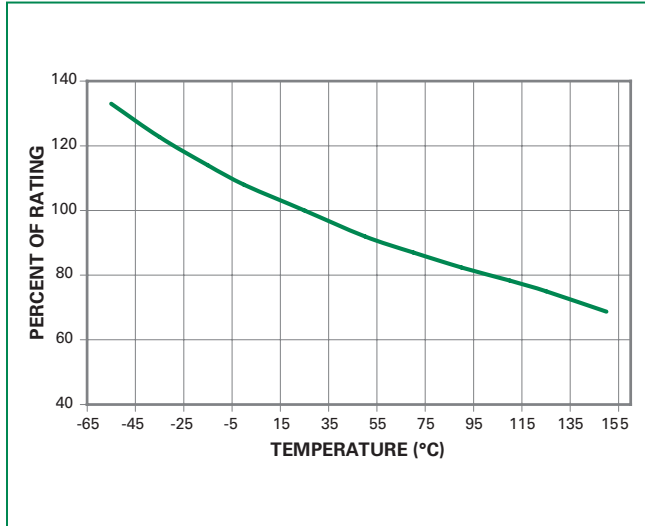

Note:

1. Derating depicted in this curve is in addition to the standard derating of 20% for continuous operation.

Example:

For continuous operation at 75 degrees celsius, the fuse should be derated as follows:

$$I = (0.80)(0.85)I_{RAT} = (0.68)I_{RAT}$$

### Average Time Current Curves

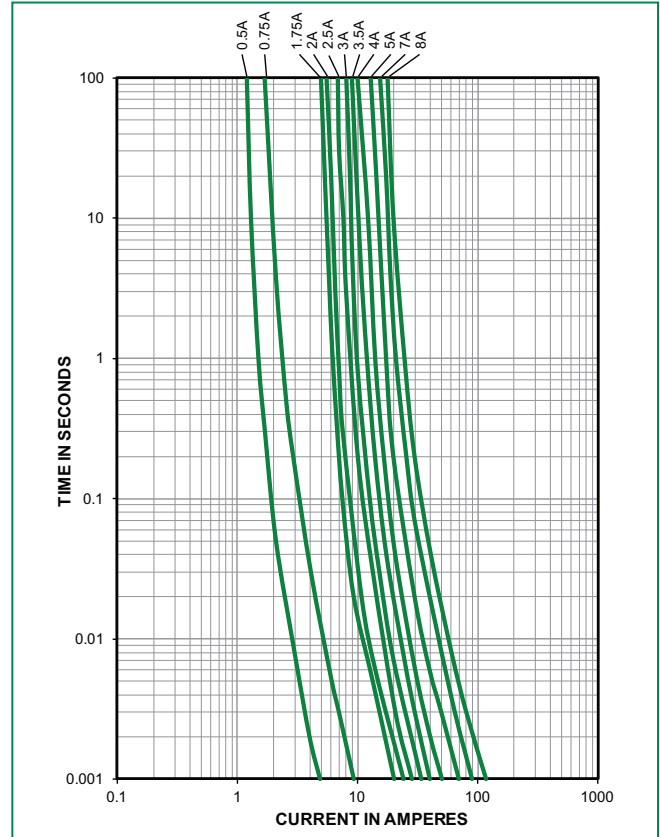

### Soldering Parameters

Reflow Condition		Pb-free assembly
Pre Heat	- Temperature Min ( $T_{s(min)}$ )	150°C
	- Temperature Max ( $T_{s(max)}$ )	200°C
	- Time (Min to Max) ( $t_s$ )	60 – 180 seconds
Average Ramp-Up Rate (Liquidus Temp ( $T_L$ ) to peak)		3°C/second max.
$T_{s(max)}$ to $T_L$ - Ramp-up Rate		5°C/second max.
Reflow	- Temperature ( $T_L$ ) (Liquidus)	217°C
	- Temperature ( $t_L$ )	60 – 150 seconds
Peak Temperature ( $T_p$ )		260 <sup>+0/-5</sup> °C
Time within 5°C of actual peak Temperature ( $t_p$ )		10 – 30 seconds
Ramp-down Rate		6°C/second max.
Time 25°C to peak Temperature ( $T_p$ )		8 minutes max.
Do not exceed		260°C

Wave Soldering	260°C, 10 seconds max.
----------------	------------------------

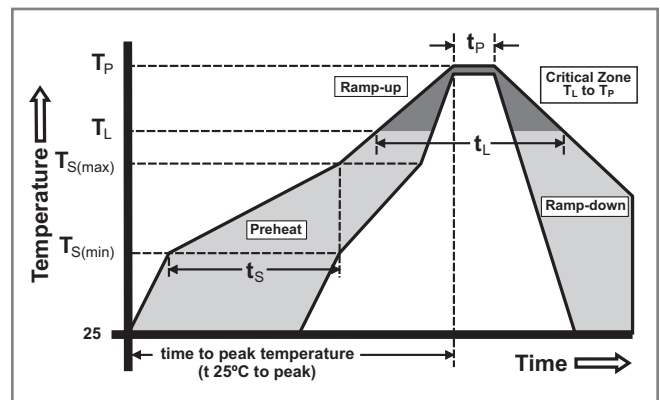

### Product Characteristics

<b>Materials</b>	<b>Body:</b> Advanced Ceramic <b>Terminations:</b> Ag / Ni / Sn (100% Lead-free) <b>Element Cover Coating:</b> Lead-free Glass
<b>Moisture Sensitivity Level</b>	IPC/JEDEC J-STD-020, Level 1
<b>Solderability</b>	IPC/ECA/JEDEC J-STD-002, Condition C
<b>Humidity Test</b>	MIL-STD-202, Method 103, Conditions D
<b>Resistance to Solder Heat</b>	MIL-STD-202, Method 210, Condition B
<b>Moisture Resistance</b>	MIL-STD-202, Method 106
<b>Thermal Shock</b>	MIL-STD-202, Method 107, Condition B
<b>Mechanical Shock</b>	MIL-STD-202, Method 213, Condition A
<b>Vibration</b>	MIL-STD-202, Method 201
<b>Vibration, High Frequency</b>	MIL-STD-202, Method 204, Condition D
<b>Dissolution of Metallization</b>	IPC/ECA/JEDEC J-STD-002, Condition D
<b>Terminal Strength</b>	IEC 60127-4

<b>High Temperature Storage</b>	MIL-STD-202, Method 108 with exemptions
<b>Thermal Shock Test</b>	JESD22 Method JA-104, Test Conditions B and N
<b>Biased Humidity</b>	MIL-STD-202, Method 103, 85C/85% RH with 10% operating power for 1000 hrs
<b>Operational Life</b>	MIL-STD-202, Method 108, Test Condition D
<b>Resistance to Solvents</b>	MIL-STD-202, Method 215
<b>Mechanical Shock</b>	MIL-STD-202, Method 213, Test Condition C
<b>High Frequency Vibration</b>	MIL-STD-202, Method 204
<b>Resistance to Soldering Heat</b>	MIL-STD-202, Method 210, Test Condition B
<b>Solderability</b>	JESD22-B102E Method 1
<b>Terminal Strength for SMD</b>	AEC Q200-006
<b>Board Flex</b>	AEC Q200-005
<b>Electrical Characterization</b>	3 Temperature Electrical

### Dimensions

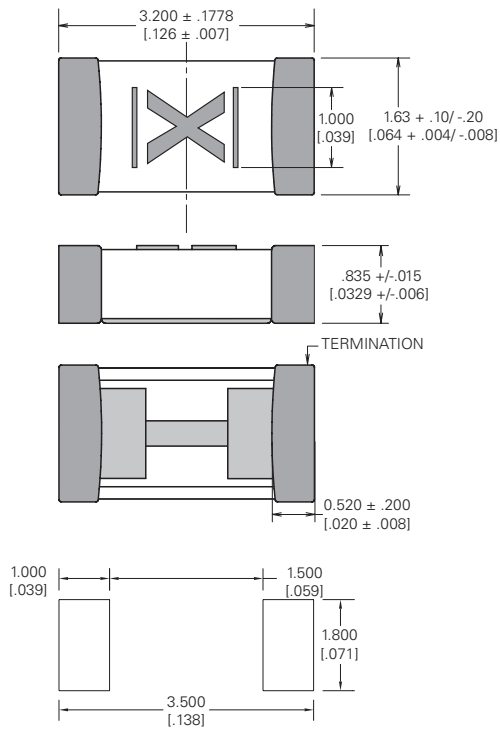

### Part Marking System

Amp Code	Marking Code
.500	<b>F</b>
.750	<b>G</b>
1.75	<b>L</b>
002.	<b>N</b>
02.5	<b>O</b>
003.	<b>P</b>
03.5	<b>R</b>
004.	<b>S</b>
005.	<b>T</b>
007.	<b>W</b>
008.	<b>X</b>

### Part Numbering System

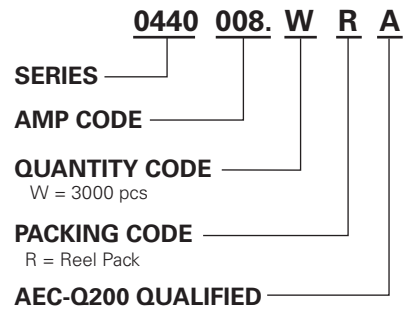

### Packaging

Packaging Option	Packaging Specification	Quantity	Quantity and Packaging Code
8mm Tape and Reel	EIA-481, IEC 60286, Part 3	3000	WRA