

EnerChip™ Energy Processor for Energy Harvesting Applications

Features

- Use any type of Energy Harvesting (EH) transducer: Light, Vibration, Thermal, RF, etc.
- Advanced Maximum Peak Power Tracking Algorithms for High Efficiency Energy Conversion
- EH Transducer to System Load Impedance Matching
- Communications Interface to System MCU
- Energy Status Indicators for Incoming Energy and Storage Energy Levels
- Charge Control for EnerChip CBC050 Thin Film Energy Storage Devices
- Built-in Energy Storage Protection
- Temperature Compensated Charge Control
- Adjustable Switchover Voltage
- Low Standby Power
- 38 pin TSSOP Package
- -20 °C to +70 °C or -40 °C to 85 °C Temperature Operating Range options
- SMT - Lead-Free Reflow Tolerant
- RoHS Compliant

Energizing Your Innovation

Many new energy harvesting based products can be enabled by the EnerChip™ EP:

- Various ambient energy sources can be harvested to power new designs using : Photo Voltaic Cells, Piezoelectric vibration harvesters, Thermoelectric cells, Electromagnetic harvesters, RF Induction charging.
- Designs can use ultra low power by leveraging the Maximum Peak Power Tracking capabilities of the EnerChip EP
- The power management communications interface to the system MCU can be used to create “Energy Aware” systems
- Input power measurement and status reporting
- Advanced energy storage management
- Uses digital power controls

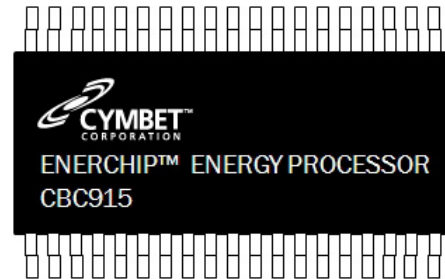

Everything is Inside the EnerChip EP

The EnerChip EP uses an advanced Maximum Peak Power Tracking (MPPT) algorithm that constantly matches the EH transducer output impedance. MPPT is the most efficient method of converting energy from an EH transducer and is superior to charge accumulation techniques that do not match the impedance of the transducer to the power conversion stage. The EnerChip EP operates in multiple modes and can communicate with microcontrollers. The EP manages all aspects of energy storage devices/peripherals and uses intelligent power management during the start-up initialization sequence. The EP operates at 1/10 the power of other EH power management units.

Ideal for “Internet of Things” Wireless Sensors

The key to designing energy harvesting-based wireless sensors with high efficiency power conversion is to utilize the EnerChip EP along with EnerChip rechargeable energy storage devices. The EnerChip EP performs the high efficiency energy conversion, energy storage and power management. It is the key enabler of “Zero Power” systems as shown in the following diagram:

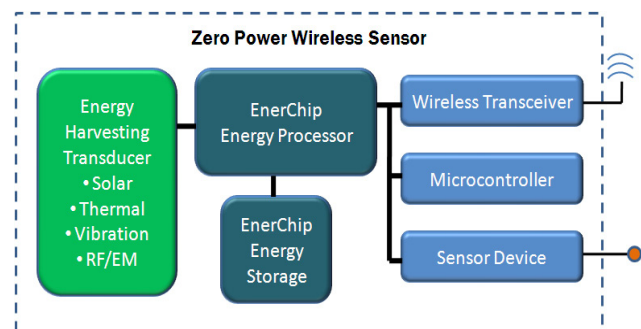

CBC915 EnerChip Energy Processor

EnerChip EP Solves the Challenges of Energy Harvesting

There are many exciting new applications that could use Energy Harvesting for powering devices. Unfortunately, utilizing the “free” ambient energy surrounding a system is a complex design challenge, with many questions to answer including:

- How to interface to energy harvesting transducers?
- How to convert low input power with high efficiency?
- How to manage energy storage?
- How to control power to the rest of the system?
- How to best manage the system power states?
- How to make the entire system “Energy Aware”?

The EnerChip™ Energy Processor solves these challenges by implementing an intelligent integrated approach to Energy Harvesting Power Management.

Introducing Maximum Peak Power Tracking - the Key to High Efficiency Systems

In order to achieve maximum power transfer from an Energy Harvesting transducer, it is critical to match the transducer impedance to the system load impedance. Therefore, P_{max} is when $R_T=R_L$.

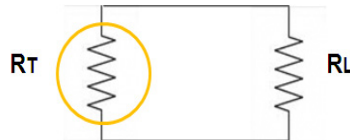

The EnerChip EP as the Energy Processing Stage serves to match the impedances of the transducer to the power converter and decouples the system load from the energy conversion circuits while also controlling the energy storage elements in the system.

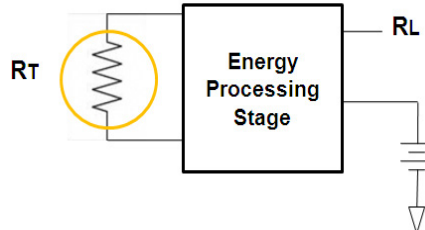

Factory Test	1	38	EN VOUT
DVDD	2	37	MODE SEL3
NC	3	36	EN VCAP
DVSS	4	35	CALIBRATE
EC CHG	5	34	LX
EN CAP CHG	6	33	CUTOFF EN
RST	7	32	MODE SEL2
VGSENSE	8	31	ISOLATE EN
MPPT	9	30	VCAP
ECFB	10	29	MODE SEL1
CAPCHG	11	28	MODE SEL0
NC	12	27	CUTOFF RST
NC	13	26	RXD
STATUS SW	14	25	TXD
AVSS	15	24	NC
AVDD	16	23	NC
NC	17	22	NC
NC	18	21	NC
NC	19	20	NC

EnerChip Energy Processor CBC915-ACB Pin Designations

CBC915 EnerChip Energy Processor

EnerChip Energy Processor CBC915 Pin Descriptions

Pin Number	Pin Designation	Description - (Input or Output)
1	Factory Test	Factory test pin - leave unconnected (I)
2	DVDD	Digital supply voltage (same as AVDD) (I)
3	NC	Not used - leave unconnected (NC)
4	DVSS	Digital ground reference (same as AVSS) (I)
5	EC CHG	EnerChip charge indicator, pin pulses low in response to STATUS SW/ (O) ⁽¹⁾
6	EN CAP CHG	Enable Capacitor Charge goes low while charging the output capacitor (O)
7	RST	Tie this pin to DVDD through a 100kΩ resistor (I)
8	VGSENSE	Voltage generator input - range 0V to 2.5V (I)
9	MPPT	Maximum Peak Power Tracking indicator (O) ⁽¹⁾
10	ECFB	EnerChip charge voltage feedback input (I)
11	CAP CHG	Capacitor Charge indicator; this pin pulses low in response to STATUS SW/ (O) ⁽¹⁾
12	NC	Not used - leave unconnected
13	NC	Not used - leave unconnected
14	STATUS SW	Status state switch (see Status Indicators section) (I)
15	AVSS	Analog ground reference - tie to system ground (same as DVSS) (I)
16	AVDD	Analog supply voltage (same as DVDD) (I)
17	NC	Not used - leave unconnected
18	NC	Not used - leave unconnected
19	NC	Not used - leave unconnected
20	NC	Not used - leave unconnected
21	NC	Not used - leave unconnected
22	NC	Not used - leave unconnected
23	NC	Not used - leave unconnected
24	NC	Not used - leave unconnected
25	TXD	Serial I/O transmit data out of the Energy Processor Data rate is 9600 8N1 (O)
26	RXD	Serial I/O receive data into the Energy Processor Data rate is 9600 8N1 (I)
27	CUTOFF RST	A high level will cause the EnerChip to disconnect from the system load (O)
28	MODE SEL0	Used in conjunction with MODE SEL1 to select transducer type (I) ⁽²⁾
29	MODE SEL1	Used in conjunction with MODE SEL0 to select transducer type (I) ⁽²⁾
30	VCAP	Output capacitor feedback monitor (I)
31	ISOLATE EN	A low level will isolate all loads from the Energy Processor (O)
32	MODE SEL2	Not used - leave unconnected (future product enhancement) (NC) ⁽²⁾
33	CUTOFF EN	A high level will force the EnerChip to connect to the system load (O)
34	LX	Boost converter switch driver (O)
35	CALIBRATE	Only used in target system calibration (see Calibration Function section) (I)
36	EN VCAP	When high connects the VCAP A/D pin to the output capacitor (O)
37	MODE SEL3	Used to select output priority or battery priority mode (I) ⁽²⁾ (not on CBC915-ACA)
38	EN VOUT	When low connects power to the application system (O)

⁽¹⁾ This pin must be connected to a 1 kohm pull-up resistor or resistor with series LED to the positive supply. See Figure 3 and the section titled "Status Indicators" for more information.

⁽²⁾ See "Operating Modes" section for more detail.

CBC915 EnerChip Energy Processor

EnerChip Energy Processor CBC915 Operating and Maximum Parameters

Parameter	Min	Typ	Max	Unit
Recommended Operating Conditions				
Supply voltage VDD	2.5	3.5	3.6	V
Supply voltage VSS	-	0	-	V
Operating temperature - CBC915-ACB	-20	+25	+70	°C
Operating temperature - CBC915-AIB	-40	+25	+85	°C
Absolute Maximum Ratings				
Voltage applied at VDD to VSS	-0.3	-	4.1	V
Voltage applied to any pin	-0.3	-	VDD+0.3	V
Diode current at any device terminal	-2	-	-2	mA
Storage temperature range	-55	-	+105	°C

Notes:

- Thermal or electrical stresses beyond those listed under absolute maximum ratings may cause permanent damage to the CBC915. These are stress ratings only, and functional operation of the device at these or any other conditions beyond those indicated under recommended operating conditions is not implied. Exposure to absolute maximum rated conditions for extended periods may affect device reliability.

EnerChip Energy Processor CBC915 I/O Pin Characterization

Parameter	Conditions	VDD	Min	Typ	Max	Unit
Positive-going input threshold voltage		3.5	1.59	-	2.63	V
Negative-going input threshold voltage		3.5	0.88	-	1.91	V
Input voltage hysteresis		3.5	0.36	-	-	V
Pullup/Pulldown resistor	for pullup, VIN=VSS for pulldown, VIN=VDD		20	35	50	kΩ
Input Capacitance	VIN=VSS or VDD		-	5	-	pF
High impedance leakage current	See notes 1 and 2	3.5	-	-	+/- 50	nA
VOH - High level output voltage	100uA	3.5	VDD-0.25	-	VDD-0.1	V
VOL - Low level output voltage	100uA	3.5	VSS	-	VSS+0.1	V
Internal clock frequency tolerance	25 °C 0 to 80 °C	N/A	-	+/- 1% +/- 2.5%	-	MHz

Notes:

- The leakage current is measured with VDD or VSS applied to the corresponding pin(s) unless otherwise noted.
- The leakage of the I/O pins is measured individually. The I/O pin is selected for input and the pullup/pulldown resistor is disabled. All inputs except STATUS SW/ and CALIBRATE/ are high impedance inputs.

CBC915 EnerChip Energy Processor

CBC915 Operation

The CBC915 performs the function of efficiently converting energy from an external power transducer to a voltage and current usable by typical applications such as remote wireless sensors. The CBC915 performs this function by dynamically matching its input impedance to the output impedance of the transducer. At impedance match, maximum power will be extracted from the transducer.

Differences Among Power Transducers

There are many different types of power transducers used in energy harvesting applications; they are broadly divided into two categories. Photovoltaic (PV) cells are unique and consequently in their own category due to the diode-like current-voltage (IV) characteristics of PV cells. The PV cell impedance changes with changes in incident light intensity. As the light intensity increases, the PV cell impedance decreases. For example, typical impedance for a 30cm² two-series amorphous silicon cell array will be 1k Ω at 1000Lux and 5k Ω at 200Lux. Therefore, transferring maximum power from the PV cell into CBC915 Energy Processor boost converter requires the input impedance of the boost converter to change dynamically in response to light intensity (thus PV cell impedance) fluctuations. Plotting a load line of current vs. voltage on a graph will show a diode-like response curve, in contrast to a purely resistive source which having a linear load line response. When presented with a matched impedance, the output voltage of an efficient PV cell is fairly constant over varying incident light intensity. In contrast, the voltage at the peak power point of a less efficient voltage will change with variations in light intensity. The CBC915 adjusts its input impedance to match the output characteristics of any type or quality of PV cell. The CBC915 was designed to work with PV cells arrays of 1-series to 8-series cells, equating to approximately 0.5V to 4V at matched impedance. In most cases it is most power efficient to use a PV array with two cells in series. Series-cell configurations with fewer cells have the advantage of not losing as much efficiency due to shading and have more efficiency per unit area because there are fewer gaps in the array that do not contribute to energy conversion.

The power curve of Figure 1 is typical of a low power PV cell used in energy harvesting applications. Electrical impedance of the cell varies strongly as a function of ambient light. As illustrated, the power curve is highly non-linear, meaning that connecting an electrical load to the PV cell that is not matched to its impedance results in inefficient power transfer to that load.

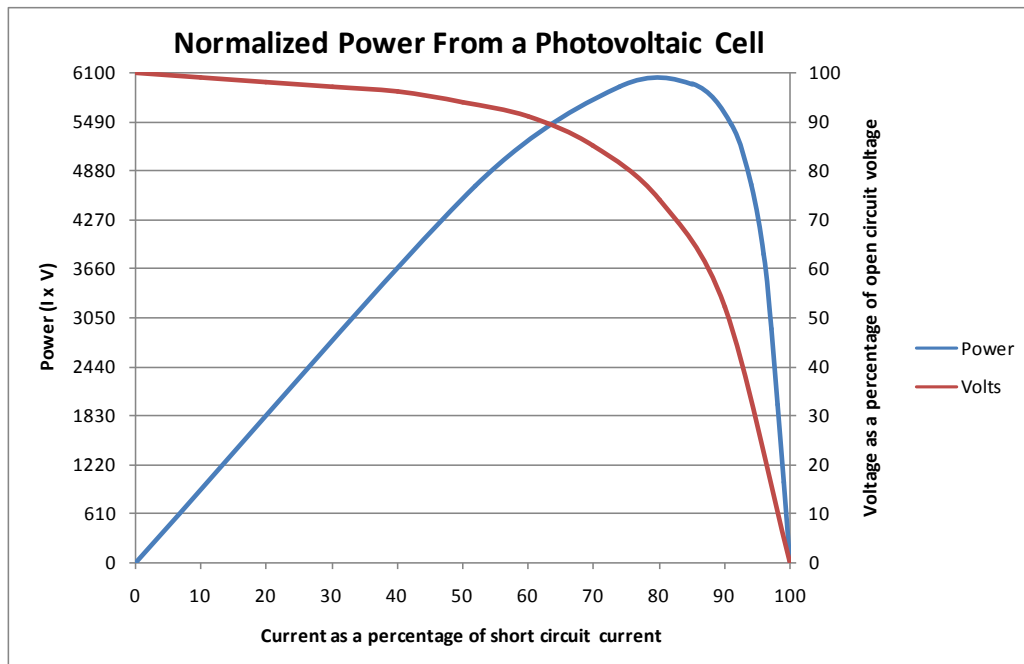

Figure 1. Maximum Peak Power Point for Variable Resistance Transducer

CBC915 EnerChip Energy Processor

Most other energy harvesting transducers (e.g., thermoelectric and piezoelectric generators) have constant output impedance. These constant impedance transducers can be further categorized into subgroups based on impedance and typical output voltage.

Most - but not all - thermoelectric generators (TEGs) have low impedances (less than 300Ω) and output voltages that vary linearly with the temperature difference across the generator. The matched impedance output voltage of a TEG used in an energy harvesting application is typically in the low tens of millivolts to around 1V depending on the number of elements in the TEG and temperature difference across the TEG. The CBC915 energy processor is designed to work with TEGs with several hundred ohms of impedance and open circuit output voltages ranging from 500mV to 2V. Extracting maximum efficiency from a TEG requires careful mechanical design which allows good thermal conduction from the hot to cold side of the TEG but at the same time insulates any thermal leakage path around the TEG that can reduce the temperature differential. Piezoelectric generators also have a constant impedance characteristic, in that changes in input excitation cause a fairly linear change in output voltage.

Piezoelectric generators typically have output impedances in the $10k\Omega$ to $100k\Omega$ range, with output voltage that changes linearly with input excitation. Most piezoelectric energy harvesters elements resonate at only one particular frequency with a power bandwidth of only a few Hertz (2-3Hz being typical). The CBC915 Energy Processor is designed to work with piezoelectric generators having an output voltage - after rectification and filtering into a matched load - ranging from 4.5V to 20V DC.

The current-voltage (I-V) profile depicted in Figure 2 is indicative of a constant impedance transducer. From the I-V curve, it is evident that operation at a point away from the peak power point results in a significant reduction of power available from the transducer and therefore to the load. Consequently, to transfer a useful amount of power to the load when input power is scarce, it is imperative to match the impedance of the transducer; moreover efficient power conversion using impedance matching must be done dynamically, as the transducer I-V profile will often vary in accordance with fluctuations in ambient conditions.

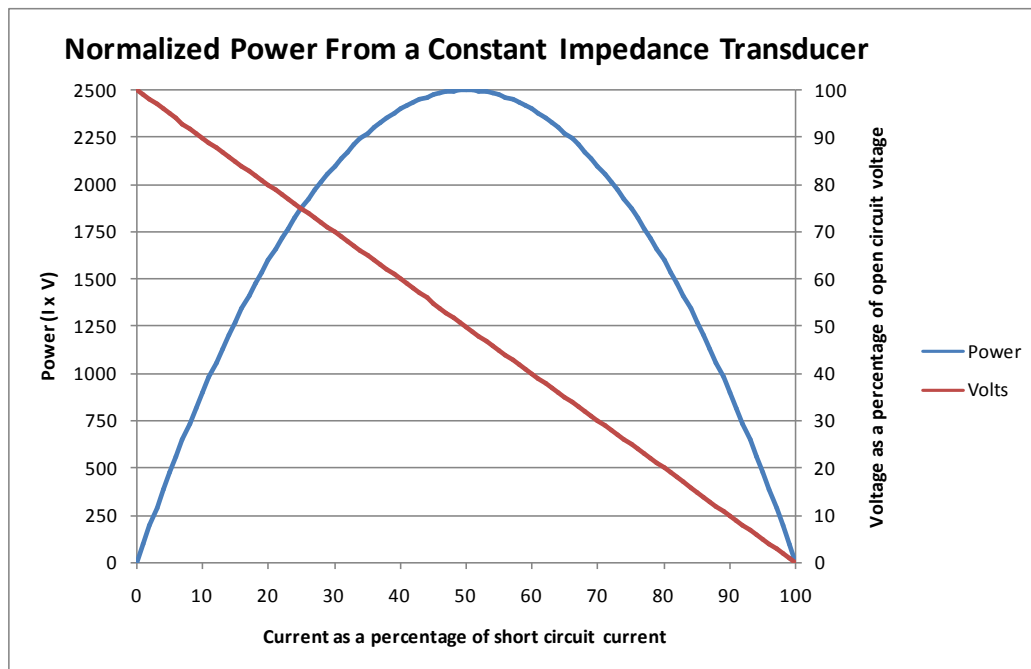

Figure 2. Current-Voltage Profile of a Constant Impedance Transducer

CBC915 EnerChip Energy Processor

Electromagnetic generators used for typical energy harvesting applications have an output impedance of several hundred ohms to several thousand ohms with an impedance of approximately $1k\Omega$ being typical. The output voltage of an electromagnetic generator will change linearly with input excitation. In most applications, voltages in the range of 500mV to 2V DC after rectification and filtering are typical.

CBC915 operation with a thermoelectric generator (TEG) transducer (as shown in Figure 3) starts with a temperature differential across the TEG. This temperature differential causes the TEG to generate a voltage. When that voltage reaches approximately 400mV, the input charge pump will start, boost the input voltage, and store the accumulated charge in capacitor C_{boost} . When the accumulated charge voltage reaches approximately 2.4V, the charge accumulated on C_{boost} will be released onto the CBC915 power rail, activating the CBC915. Upon activation, the CBC915 outputs are initialized to a known state and the input mode pins will be interrogated in order to recognize the transducer type. The CBC915 will then pulse-width modulate the LX pin and initiate operation of the boost converter. When the boost converter voltage rises above 2.4V, power to the input charge pump is removed to reduce quiescent current. The CBC915 then checks for voltage on the output capacitor (C_{out}) by setting the EN VCAP pin high and reading the output capacitor voltage on VCAP pin. If the capacitor is charged, the CBC915 will leave the capacitor connected to the VOUT pin and EnerChips. If the capacitor has not been charged, the CBC915 will turn off the VOUT connection by setting EN VOUT/ pin high and isolate the capacitor from the EnerChips by setting EN CAP CHG/ pin high. The CBC915 will then check the boost converter voltage by monitoring the voltage at the VOUT pin and wait for the voltage to reach 4.06V at which time the CBC915 will enter the maximum peak power tracking state (MPPT) and pulse the MPPT/ status pin low and start adjusting the boost converter input impedance to match the output impedance of the TEG. This process can take several minutes. The MPPT state is only entered at initial power-on and values are subsequently stored. Note the MPPT state can be entered by five different events:

- at initial power up;
- when powered up while the Status/ input is held low
- by command over the serial interface;
- by detection of the input voltage being at a lower level than what it was at the initial MPPT startup while VOUT is not in regulation (voltage to low);
- when the input voltage is at a higher level and VOUT is not in regulation (voltage too high).

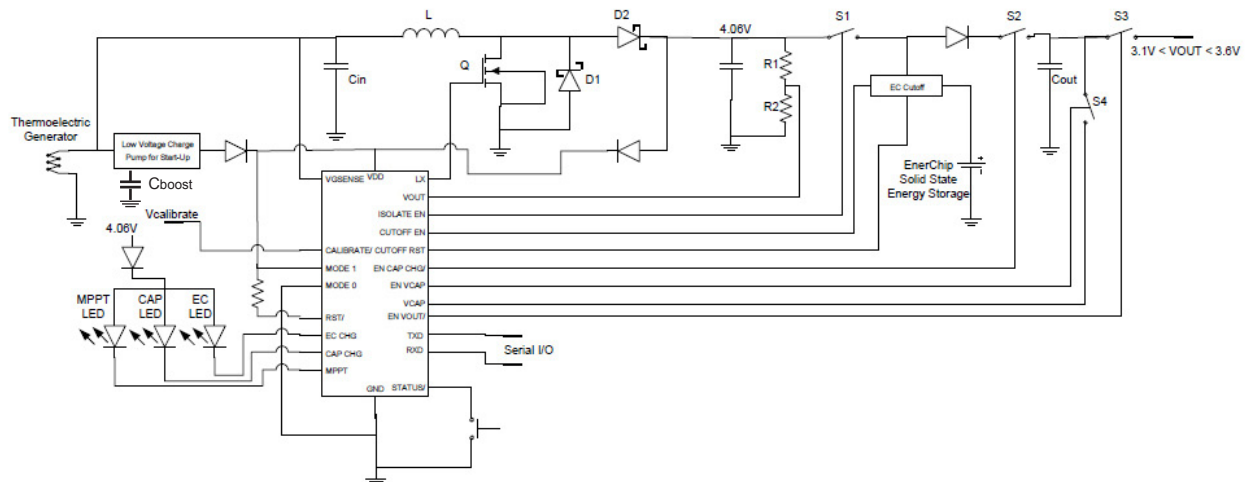

Figure 3. CBC915 Energy Processor Application Circuit

CBC915 EnerChip Energy Processor

In all cases while in the MPPT state, the boost converter is isolated from the EnerChip(s), output capacitor, and load. During MPPT mode, the load will be operating from the energy stored in the output capacitor and EnerChip(s). Once the maximum peak power point is found, the CBC915 will then set the ISOLATE EN line high to connect the boost converter to the power management circuits, then repeatedly pulse the CAP CHG pin low. The periodic pulsing of EN CAP CHG/ pin low enables small amounts of charge energy to be transferred from the boost converter to the output capacitor with each low pulse on the EN CAP CHG/ pin. While the output capacitor is being charged, the CBC915 will monitor the output capacitor voltage on the VCAP pin. When the output capacitor voltage rises to 2V, the CBC915 will stop pulsing and set the EN CAP CHG/ pin low continuously; this state allows maximum energy to be transferred from the boost converter into the output capacitor. When the output capacitor voltage reaches 3.4V, the CBC915 will set the EN VOUT/ line low, connecting the output capacitor to the application system load. At the same time, the CBC915 will pulse the EC CHG/ line low and pulse the CUTOFF RST line high, thereby connecting the EnerChip to the boost converter, output capacitor, and applying power to the application system load. The MODE SEL3 pin controls the charging behavior. If MODE SEL3 is high, the output capacitor will charge and the System load will be powered before the EnerChips are charged. If MODE SEL3 is low, the EnerChips will be charged before the system load is connected and the CBC915 will set the EN VOUT/ line low, connecting the output capacitor and EnerChips to the load. On the CBC915-ACA, MODE SEL3 is fixed high. The purpose for the MODE SEL3 pin is to select whether to power the system load before or after the EnerChips are charged, so users can select the priority of whether the system load is powered quickly or the batteries are charged quickly. The CBC915 then monitors the output of the boost converter; when the boost converter is in regulation the CBC915 will simultaneously pulse low the EC CHG/, CAP CHG/, and MPPT/ pins. This state indicates the output is turned on and the system is in regulation, which typically happens once the EnerChips have nearly a full charge.

Calibration Function

The CBC915 features a calibration function to remove errors caused by unit to unit variation in the voltage divider resistors (R1 and R2 of Figure 3) used to drive the ECFB input. The CALIBRATE/ pin has an internal pull up resistor and can be driven by an open drain/collector output or switch contact. To calibrate apply 4.06V to the V+ node. Then short the CALIBRATE/ pin to ground for approximately 100mS. The EC CHG LED/, MPPT LED/, and CAP CHG/ pins will simultaneously pulse low when the CBC915 has stored its calibration values.

Operating Modes

MODE SEL0 and MODE SEL1 determine which transducer type is being used.

- Type 0: Electromagnetic transducers; input voltage range 0.5V to 4V after rectification and filtering.
- Type 1: Thermoelectric generators; input voltage range 400mV for startup. 200mV to 1V at matched impedance.
- Type 2: Piezoelectric generators; input voltage range 4V to 20V after rectification, loaded to matched impedance.
- Type 3: Photovoltaic cells; 900mV to 4V at matched impedance.

MODE SEL3 (not available on CBC915-ACA) dictates whether the EnerChips get charged before being connected to the output (MODE SEL3 = low), or the Enerchips will begin charging when the output is connected to the load (MODE SEL3 = high).

Type	MODE SEL3	MODE SEL2	MODE SEL1	MODE SEL0
0 (Electromagnetic)	X	X	Low	Low
1 (Thermoelectric)	X	X	Low	High
2 (Piezoelectric)	X	X	High	Low
3 (Photovoltaic)	X	X	High	High

CBC915 EnerChip Energy Processor

EnerChip EP Communications Interface and Commands

The CBC915 has seven serial I/O commands to enable the end application to be “energy aware”. The serial I/O UART is configured as 9600 Bits per second, 8 bits, no parity bit, 1 stop bit. 9600 8N1.

The I/O lines are TXD and RXD, described as follows:

TXD - Serial I/O transmit data out of the Energy Processor. Data rate is 9600 8N1 (Output from CBC915)

RXD - Serial I/O receive data into the Energy Processor. Data rate is 9600 8N1 (Input to CBC915)

The serial I/O commands are:

Command 1 (Not available on CBC915-ACA): Power Available. This command returns - in microwatts - the total power available from the energy harvesting transducer. The application can use this information to change its performance characteristics depending on the input power available. This command is typically used in conjunction with command 4 (Find Maximum Peak Power Point)

Command 2 (Not available on CBC915-ACA): State of CBC915. This command returns the current state of the CBC915. The CBC915 is always in one of five different states:

State 1: Maximum Peak Power Tracking (MPPT). In this mode, the CBC915 adjusts the impedance of the power conversion stage to match the output impedance of the energy harvesting transducer. While in State 1, the load is not powered from the energy harvester.

State 2: Capacitor Charging. While in State 2, the CBC915 charges the output capacitor. This state is typically entered only once at initialization or if the EnerChips were to become deeply discharged. While in State 2, the output capacitor is isolated from the load until the output capacitor has reached full charge.

State 3: EnerChip Charging. This state is entered after the output capacitor charging state is completed and the system is not in regulation. During State 3 power is applied to the load.

State 4: System in Regulation. This state is entered when the system is in regulation.

State 5 Output Off. This state would typically only be detected and used in a laboratory environment, as power would normally be turned off to the load and thus prevent serial communications.

Command 3 (Not available on CBC915-ACA): Transducer Type. This command is typically used during production test to ensure the mode input pins have been set to the correct value for the particular transducer being used.

Command 4: Find Maximum Peak Power Point. To conserve power, the CBC915 only finds the maximum peak power point once at initialization or anytime the CBC915 falls out of regulation (voltage to high or low) while at the same time detecting a change in input voltage. If it is desired to reset the maximum peak power point the host microcontroller can force the CBC915 to find the maximum peak power point. While this command is being executed power from the energy harvester is cut off to the application and the application system will get its power while the CBC915 is finding the peak power point from the EnerChip(s) and output capacitor. This command would typically only be used on systems using PV cells that change impedance with changes in light level, other transducer types with constant impedance would typically derive little if any benefit from a reset of the peak power point.

Command 5: EnerChip State of Charge. This command returns the state of charge as a percentage of total capacity. This indicator is based on a voltage measurement and will not be totally accurate as the EnerChips age, or with large deviations from room temperature.

CBC915 EnerChip Energy Processor

Command 6: Calibrate EnerChip EP. This command requires a 4.06V power supply to be connected to the converter output. This command reads current A/D voltage and set as new A/D reading as 4.06 volts for the output A/D converter. This command can also be implemented with hardware using the CALIBRATE/ input line.

Command 7: This command returns as a single string data from:

- Command 1 (Power Available)
- Command 2 (State of the CBC915)
- Command 3 (Transducer Type)
- Command 5 (EnerChip State of Charge)

Command 8: Serial Communications Test Command. This command requests verification that the serial port is communicating, by requesting a return of the value <99>.

Command 9 (Not available on CBC915-ACA): Measure Transducer Power Available.

This command measures the maximum input power available from the transducer (in the current operating environment). This command can take up to 10 seconds to complete, so a read power command (Command 7 or Command 1) should not be sent before 10 seconds has elapsed. When the command is complete the system will return to its previous mode.

EnerChip EP Serial Port Command and Response Syntax

The CBC915 supports a command/response protocol on the serial port. The syntax for the commands and responses is listed as follows.

Characters not enclosed in <> are case-sensitive required ASCII characters. 0 = null (hex 0).
Do not insert extra white-space characters.

<XX> is defined as an ASCII decimal number of exactly the same number of digits as shown between the < and >. Leading zeros are used to left fill the field. (The < and > are not sent.)

<cr> is defined as an ASCII carriage return . (The < and > are not sent.)

<lf> is defined as an ASCII line feed. (The < and > is not sent.)

<space> is defined as an ASCII space character. (The < and > is not sent.)

Protocol Request Command to CBC915 on RXD line

<#> <space> <command number> <carriage return>

Protocol response from CBC915 on TXD line

<@> <command number> <comma> (data returned) <carriage return> <line feed> <zero>

All commands to the CBC915 take this form on the RXD line:

#<space> <X><cr>

Where X is the command number.

Example:

2<cr> requests the state of the CBC915

Protocol response from CBC915 on TXD line is as follows:

CBC915 EnerChip Energy Processor

@<X>,<DDDD><cr><lf>>0

Where <X> is an ASCII decimal number echoing the command number and <DDDD> is a specific length (4 digits in this case) ASCII decimal number. Notice the ASCII comma character between the command number and data parameter and the ASCII zero following the <cr>

Example:

@2,05<cr><lf>>0 is a response from command 2 that the CBC915 is in state 5.

Response 1 (Not available on CBC915-ACA): Power Available

<@> <command number> <comma> <XXXX> <line feed> <carriage return> <zero>
XXXX= ASCII numbers for microwatts of power (1-99999)

Example: Command request for power available #<sp>1<cr> ;where <sp> = ASCII space character and <cr> = ASCII carriage return character

Command returns @1,00237<cr><lf>>0 Where 00237 is 237uW of power available and <lf> is ASCII line feed character

Response 2 (Not available on CBC915-ACA): State of CBC915

<@> <command number> <comma> <XX><carriage return> <line feed> <zero>
XX= ASCII numbers for State (1-99)
State 1 = MPPT mode
State 2 = Capacitor charging
State 3 = EnerChip(s) charging
State 4 = System in regulation
State 5 = Output off

Response 3 (Not available on CBC915-ACA): Transducer Type

<@> <command number> <comma> <XX> <carriage return> <line feed> <zero>
XX= ASCII numbers for transducer type (1-99)
Transducer 1 = Low voltage input; typically TEG
Transducer 2 = PV cell input
Transducer 3 = High voltage input; typically piezoelectric
Transducer 4 = Medium voltage input, constant impedance transducers; typically electromagnetic generators

Response 4: Find Maximum Peak Power Point

<@> <command number> <comma> <ack> <carriage return> <line feed> <zero>
<ack>= ASCII ACK

Response 5: EnerChip State of Charge

<@> <command number> <comma> <XXX><carriage return> <line feed> <zero>
XXX= ASCII numbers as percent of full charge (requires command to be requested twice for accurate data)

Response 6: Calibrate EnerChip EP

<@> <command number> <comma> <XXXX> <carriage return> <line feed> <zero>
XXXX= ASCII numbers for A/D reading for 4.06 volts

Response 7: Returns data from Command 1, Command 2, Command 3, and Command 5

CBC915 EnerChip Energy Processor

<@> <command number> <comma> <XXXXYYZZUUU> <carriage return> <line feed> <zero>
X = ASCII numbers for POWER
Y = ASCII numbers for STATE
Z = ASCII numbers for TRANSDUCER TYPE
U = ASCII numbers for ENERCHIP percent charge

Response 8: Serial Communications Test Command

<@> <command number> <comma> <99> <carriage return> <line feed> <zero>

Response 9 (Not available on CBC915-ACA): Measure Transducer Power Available

<@> <command number> <comma> <ack> <carriage return> <line feed> <zero>
<ack>= ASCII ACK

Status Indicators

The following pins are used for the peak power tracking algorithm and **must be connected** for proper operation:

- EC CHG/ (EnerChip Charge) - indicates EnerChip charging state.
- CAP CHG/ (Capacitor Charge) - indicates capacitor charging state.
- MPPT/ (Maximum Peak Power Tracking) - indicates Maximum Peak Power Tracking (MPPT) state.

Each of these 3 pins must be either connected to a 1k Ω resistor pulled to the positive supply rail or connected to an LED in series with a current limiting resistor pulled up to the 4.06V supply rail via a diode, as shown in Figure 3. All three status lines must be connected to a load so the CBC915 has a way to bleed off excess energy while in the MPPT state. Note in Figure 3 the extra diode used to isolate the large LED currents from the CBC915 bypass capacitor. This is to prevent inadvertent resetting of the CBC915. The status indicator pins are used as a shunt regulator during peak power tracking. If these 3 pins are not connected as described, it is possible that the CBC915 can be damaged during start-up.

There is one status input pin and three status indicators.

Status Input Pin

STATUS SW/ is pulled high internally. Tie this pin to a switch or open drain/collector output to pull low. When pulled low STATUS SW/ will cause the EC CHG/, MPPT/, and CAP CHG/ lines to pulse low depending on the state of the Energy Processor. When in the normal state with power applied to the system and in regulation with fully charged EnerChips, all the lines will pulse low simultaneously. If STATUS SW/ is held low for more than 10 seconds, EN VOUT/ will go high shutting off power to the application system, subsequent pulses of less than 10 seconds will cause the EN CAP CHG/ and MPPT lines to pulse low and the EN VOUT/ line to remain in the high or power disconnected state. Holding STATUS SW/ line low for greater than 10 seconds will restore the Energy Processor to its normal state with EN VOUT/ in the low state with power applied to the application system and all three status lines pulsing low in response to a low level pulse on STATUS SW/.

When all three status indicators simultaneously pulse low, the output is connected to the load, the EnerChips are charged, and the system is in regulation. The status indicator corresponding to each state will automatically pulse low when the system enters that state. The EnerChip EP operating state can be requested by pulsing STATUS SW/ low. This will cause the corresponding indicators to pulse low.

Activating a status indicator requires a momentary (less than one second) low pulse to STATUS SW/. The associated indicator pin will then be driven low once.

Holding the STATUS SW/ pin low for approximately ten seconds will cause the CBC915 to disconnect from the load. If the STATUS/ pin is then momentarily pulsed low, the EC CHG/ and CAP CHG/ indicator pins will pulse low, indicating the batteries are charged, output is in regulation, and the load is disconnected.

CBC915 EnerChip Energy Processor

Holding the STATUS SW/ pin again for approximately ten seconds will toggle the load back to being connected to the energy harvester. The status indicators will pulse low. Any subsequent momentary push of the switch will result in all three status indicators toggling once, provided the batteries are charged and the output is in regulation. Holding the STATUS SW/ pin low until the CBC915 is powered up will force the CBC915 to enter the MPPT state.

EnerChip Charge Indicator

EnerChip charge indicator (EC CHG/) pulses low in response to STATUS SW/ being pulsed low while the EnerChip(s) is (are) being charged. EC CHG/ state is an indication that the output is connected to the energy harvester and the output voltage is not in regulation. It is possible – under direct sunlight conditions or other high power transducers for instance – for the system to be in regulation yet have EnerChips not fully charged. This indicator will be the most accurate when used indoors under normal/lower lighting conditions or with a low power transducer. This state can take from minutes to hours to complete depending on light intensity and/or energy available. In this state the output is disconnected from the energy harvester.

Capacitor Charge Indicator

Capacitor charge indicator (CAP CHG/). This pin pulses low in response to STATUS SW/ being pulsed low while the output capacitor is being charged. The CAP CHG/ state occurs only on initialization, during the time the output capacitors are being charged. This state can take minutes to hours to complete depending on the energy available at the harvesting transducer input. In this state, the EN VOUT/ output pin is driven high.

MPPT Indicator

Maximum Peak Power Tracking indicator. This pin goes low in response to STATUS SW/ being pulsed low when the Energy Processor is tracking the maximum peak power operating point. Engaging the MPPT state typically takes about a minute and occurs only when the system is first initialized or when the system can no longer stay in regulation and the input voltage has changed from the last time MPPT was completed. For example, if a light source has changed position throughout the day and the load current remains low, no MPPT will occur. If the load were to increase and light intensity increased or decreased, MPPT state will be entered to allow peak power to flow to the load. Note: Anytime the MPPT state is entered, the load, if connected, will be deriving its power from the EnerChips and not the photovoltaic cells.

EC CHG/, CAP CHG/, and MPPT/ pins must be connected to 1K ohm resistors or LEDs. The following table describes the operational modes for the several possible combinations of these three pins. Refer to CBC-EVAL-09 data sheet DS-72-13 for further clarification of mode descriptions.

PIN			MODE DESCRIPTION
EC CHG	CAP CHG	MPPT	
HIGH	HIGH	PULSED LOW	Maximum peak power tracking
HIGH	PULSED LOW	HIGH	Output holding capacitor charging
PULSED LOW	HIGH	HIGH	EnerChip charging
PULSED LOW	PULSED LOW	PULSED LOW	Normal operation; system in regulation
HIGH	PULSED LOW	PULSED LOW	Output state change; driven low when STATUS SW/ is driven low for 5 seconds
PULSED LOW	HIGH	PULSED LOW	Output to load turned off; same as EnerChip charging
PULSED LOW	PULSED LOW	HIGH	Output to load turned off; system in regulation

CBC915 EnerChip Energy Processor

Important EnerChip EP Pin Connections

The DVDD and AVDD pins should be connected together on the printed circuit board.

The DVSS and AVSS pins should be connected together on the printed circuit board.

The DVDD pin should be connected with bypass cap to the DVSS pin - typical capacitance value is 0.1uF; place as close to pins 2 and 4 as possible and in parallel a 10uF cap for low frequency decoupling

The AVDD pin should be connected with bypass cap to the AVSS pin - typical capacitance value is 0.1uF; place as close to pins 2 and 4 as possible and in parallel with a 10uF cap for low frequency decoupling.

Remember the Status Indicators: EC CHG/ (EnerChip Charge) te, CAP CHG/ (Capacitor Charge) and MPPT/ (Maximum Peak Power Tracking) must be connected to a resistor pull up or LED to insure the CBC915 has a method of shedding excess harvested energy.

Printed Circuit Board (PCB) Layout Guidelines for the CBC915 Application Circuit

The boost converter power stage consists of elements with tens of milliamperes of current along with control electronics with very high impedances operating at only a few nanoamperes of current. This disparity between current densities in the power stage vs. the control circuits can lead to poor circuit performance, poor efficiency and excessive noise coupling into other circuits if careful layout practices are not observed.

As in most switch mode power supply layouts, it is usually advantageous to isolate the power stage from the control electronics through a combination of isolated current conductors or by careful placement of power stage components in such a manner that the high currents in the power stage stay in an area associated only with the power stage components. Proper design and layout of the CBC915 application circuit will ensure maximum circuit performance.

Power stage components Cin, L, Q, D1, D2, and Cout should all be in close physical proximity to each other. When placing the components, it is better to make the traces associated with Cout the shorter path. The signal return conduction path should either be at the edge or corner of the board if a common ground plane is used, or routed together outside of the ground plane and then tied to the ground plane at a single point - preferably at the signal return connection for Cout. All traces interconnecting the power components should be as short and wide as practical; this will help eliminate parasitic inductance and conducted losses which will in turn help keep conducted noise and magnetic fields out of adjacent circuits. Doing a good job with the power stage component placement and layout will yield the best performance of the system as a whole. This area should not be compromised if maximum performance is to be achieved.

The feedback resistors R1 and R2 should be as close as practical to the VGSENSE input on the CBC915. The signal return line for resistor R2 should be isolated from the high current power stage signal return lines, either by placement of the components relative to the power stage components or by providing separate return lines.

Place bypass capacitors as near to the CBC915 VDD and VSS pins as possible. If using a power and ground plane, drop vias directly from the bypass capacitors to the power and ground planes and from the CBC915 VDD and VSS pins directly to the power and ground planes.

In general, all discrete components should be placed physically close to the gate connection of the transistor they are associated with. Keep the node lengths as short as possible to the FET gate connections.

Follow the PCB layout guidelines in the EnerChip data sheet and User Manual for details on how to minimize stray leakage paths on EnerChip package pins and PCB routing traces.

CBC915 EnerChip Energy Processor

Package Outline (38-TSSOP)

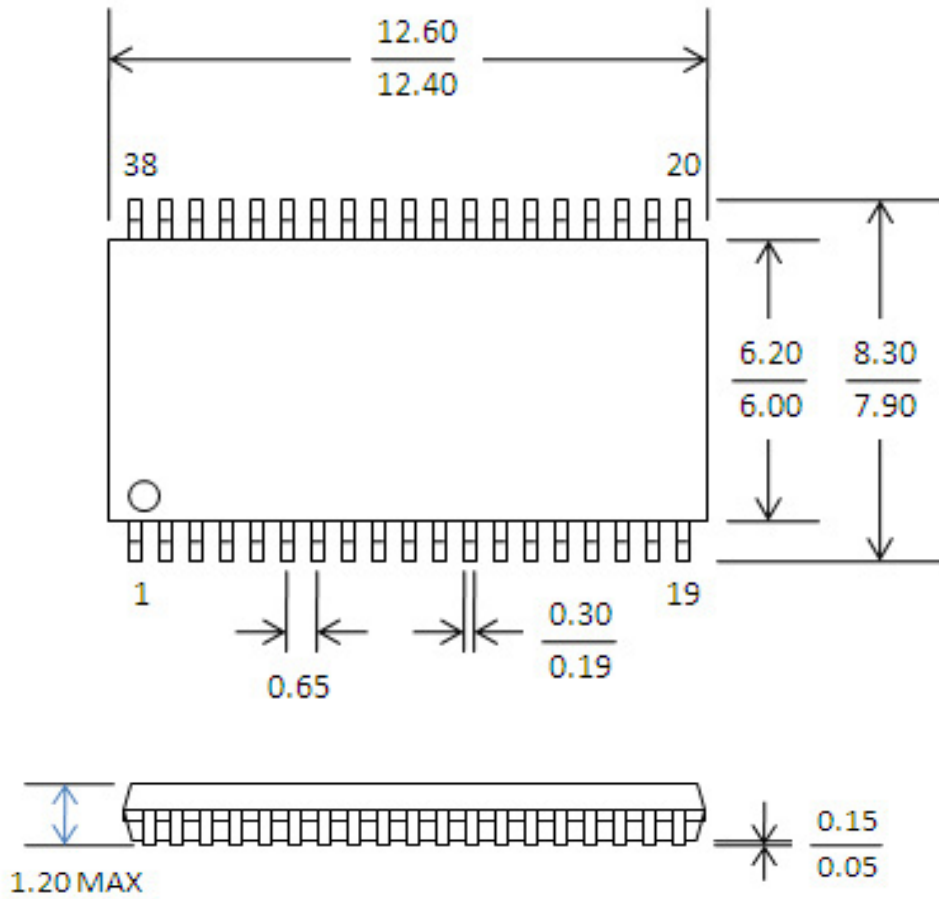

All linear dimensions in mm. (Max/Min)

CBC915 EnerChip Energy Processor

Environmental and Transportation Standards Compliance



CE is not applicable to this product



Ordering Information

EnerChip Part Number	Description	Notes
CBC915-ACA	CBC915 EnerChip Energy Processor	38-Pin TSSOP Package shipped in tubes
CBC915-ACA-TR1	CBC915 EnerChip Energy Processor	38-Pin TSSOP Package shipped as 1000 part tape and reel
CBC915-ACA-TR5	CBC915 EnerChip Energy Processor	38-Pin TSSOP Package shipped as 5000 part tape and reel
CBC915-AIA	CBC915 EnerChip Energy Processor - Industrial Temp	38-Pin TSSOP Package shipped in tubes
CBC915-AIA-TR1	CBC915 EnerChip Energy Processor - Industrial Temp	38-Pin TSSOP Package shipped as 1000 part tape and reel
CBC915-AIA-TR5	CBC915 EnerChip Energy Processor - Industrial Temp	38-Pin TSSOP Package shipped as 5000 part tape and reel
CBC915-ACB	CBC915 EnerChip Energy Processor	38-Pin TSSOP Package shipped in tubes
CBC915-ACB-TR1	CBC915 EnerChip Energy Processor	38-Pin TSSOP Package shipped as 1000 part tape and reel
CBC915-ACB-TR5	CBC915 EnerChip Energy Processor	38-Pin TSSOP Package shipped as 5000 part tape and reel
CBC915-AIB	CBC915 EnerChip Energy Processor - Industrial Temp	38-Pin TSSOP Package shipped in tubes
CBC915-AIB-TR1	CBC915 EnerChip Energy Processor - Industrial Temp	38-Pin TSSOP Package shipped as 1000 part tape and reel
CBC915-AIB-TR5	CBC915 EnerChip Energy Processor - Industrial Temp	38-Pin TSSOP Package shipped as 5000 part tape and reel
CBC-EVAL-09	EnerChip EP Universal Energy Harvesting Evaluation Kit	CBC915-AC with EnerChip 51100 module and solar cell

U.S. Patent No. 7,956,572. Additional U.S. and Foreign Patents Pending

Disclaimer of Warranties; As Is

The information provided in this data sheet is provided "As Is" and Cymbet Corporation disclaims all representations or warranties of any kind, express or implied, relating to this data sheet and the Cymbet product described herein, including without limitation, the implied warranties of merchantability, fitness for a particular purpose, non-infringement, title, or any warranties arising out of course of dealing, course of performance, or usage of trade. Cymbet products are not authorized for use in life critical applications. Users shall confirm suitability of the Cymbet battery product in any products or applications in which the Cymbet product is adopted for use and are solely responsible for all legal, regulatory, and safety-related requirements concerning their products and applications and any use of the Cymbet product described herein in any such product or applications.

Cymbet, the Cymbet Logo and EnerChip are trademarks of Cymbet Corporation. All Rights Reserved