

MODEL NO.:

- (1) Series no.
- (2) Schematic type: A,B,C
- (3) Housing color:
BK7=Black
- (4) Terminal plating:
AU03=Plating AU 3u" min.
- (5) Packing mode:L=Reel packing
- (6) Environmental requirements:
Rh=RoHS 2.0 + Halogen Free

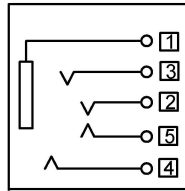

Circuit Diagram

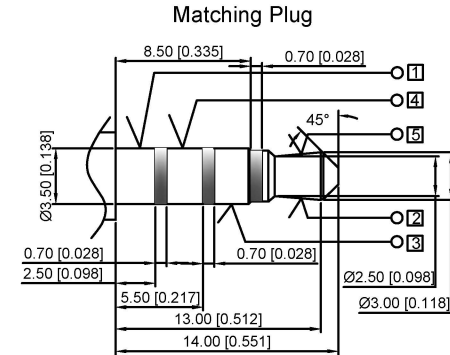
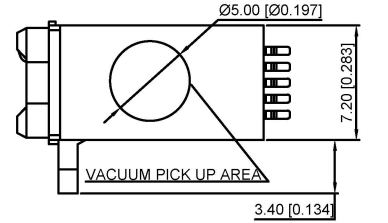
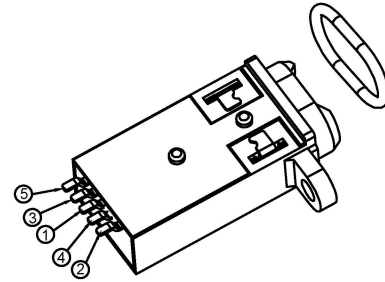
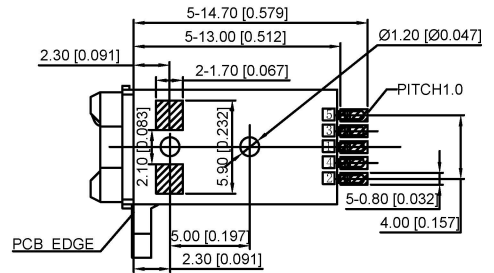
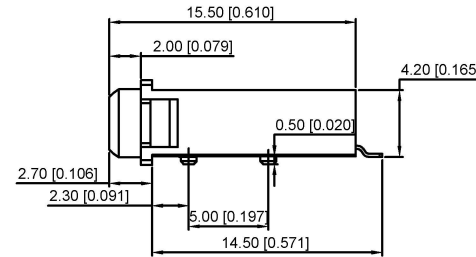
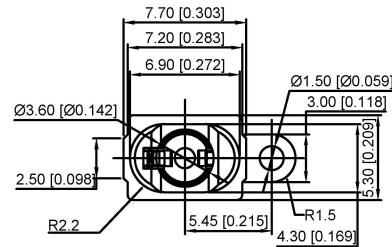

RECOMMENDED P.C.B LAYOUT
TOP VIEW (TOLRANCE:±0.05)

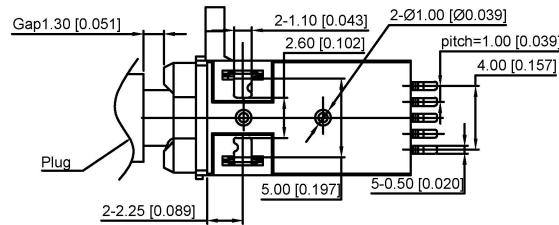

SPECIFICATION:

- 1.Electrical characteristics
 - 1-1.Current rating:DC 0.5A max.
 - 1-2.Voltage rating:DC 30V.
 - 1-3.Contact resistance:50mΩ max
 - 1-4.Insulation resistance:1000MΩ min. at 500V DC.
 - 1-5.Withstanding voltage:500V AC for 1 minute.
- 2.Mechanical characteristics
 - 2-1.Life test:5000 cycles min,
 - 2-2.Mating force:3~30N,
Unmating force:3~30N.
- 3.Temperature range: -40°C~+80°C
- 4.Dustproof and waterproof grade: IP67

广东星坤科技股份有限公司

生	日期
效	日期

MARK	DESCRIPTION	DATE	REVISED	APPROVED	REVISIONS

文件工程章

www.helloxkb.com www.helloxkb.com www.helloxkb.com

ANGLAR	±5°
L ≤ 4	±0.2
4 < L ≤ 16	±0.3
16 < L ≤ 63	±0.4
L > 63	±0.5

UNSPECIFIED TOLERANCES

DSND	DATE	SCALE: N/A	MODEL TYPE: 3.5 PHONE JACK
DWN	DATE	VIEW:	PART NO.:
CHKD	DATE	UNIT: mm/in	DWG NO.: PJ-3254
APPD	DATE	SIZE: A4	WEIGHT SHEET REVISION 1.0g 1/1 A0

XKB INDUSTRIAL PRECISION CO., LIMITED