

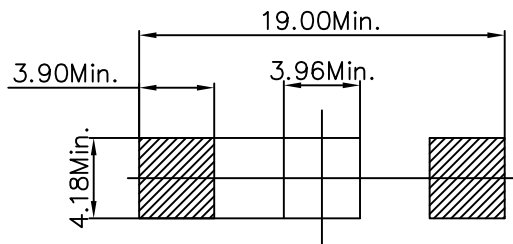

REV.	ECN NO.	REVISED	DATE

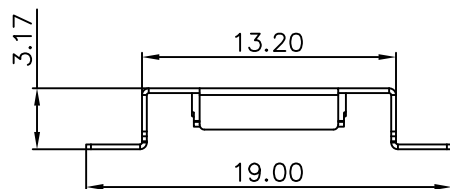
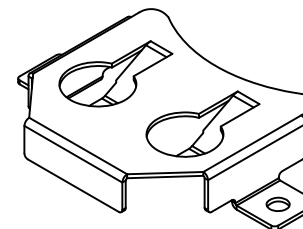
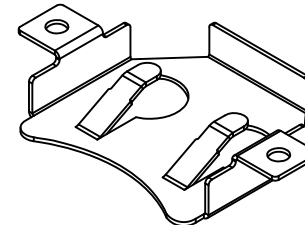
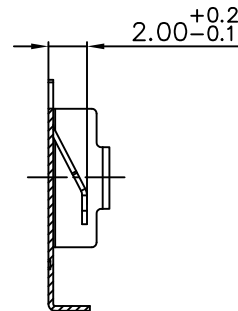
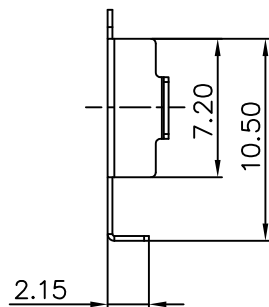
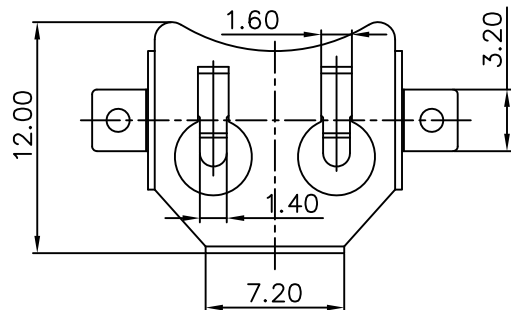

PCB Layout Diagram
Top View

工程部
2019-05-06
LQ. HUANG

技术要求:

- 1、截剪断面毛刺高度 $\leq 0.03\text{mm}$;
- 2、部件要求平整,无变形、裂纹、损伤等外观缺陷;

UNLESS OTHERWISE SPECIFIED TOLERANCES		MYOUNG 美阳 www.meiyangdz.com			
DECIMALS: X :±0.30 X.X :±0.25 X.XX :±0.20 X.XXX :±0.10	ANGLES: X :±1° X.X :±0.5°	DSND	YangFeng	DATE	2019-05-06
		CHKD	ZhouRuicai	DATE	2019-05-06
		APVD	XueShunyong	DATE	2019-05-06
WEIGHT: g		SCALE:	SIZE: A4	VIEW:	
SHEET 1 OF 1		UNIT: mm	REV.: A/1	OBJECT: MY	TITLE: 电池扣CR1220-W SMT
		PART NO.:		MY-1220-03	
		DRAW NO.:MY-CP-0210			

1	TERMINAL(+)	1	PHOSPHOR BRONZE, T=0.20mm	Ni-Plating
NO.	PART NAME	Q'TY	MATERIAL	PLATING & COLOR



REV.	ECN NO.	REVISED	DATE

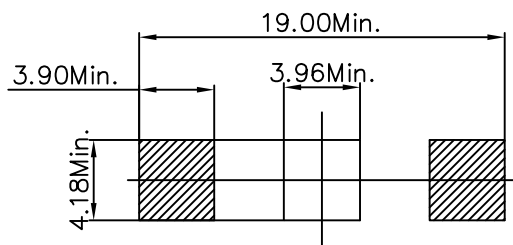
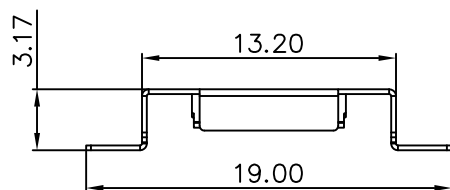
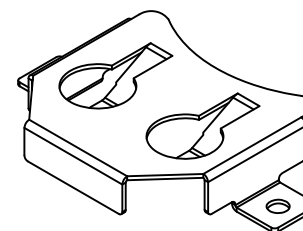
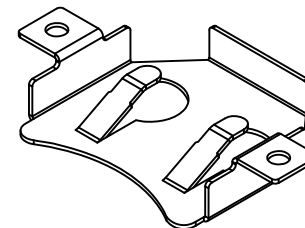
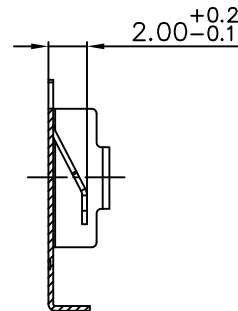
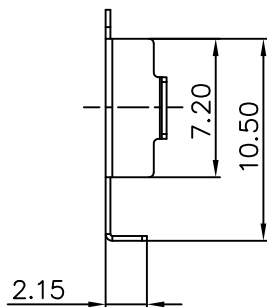
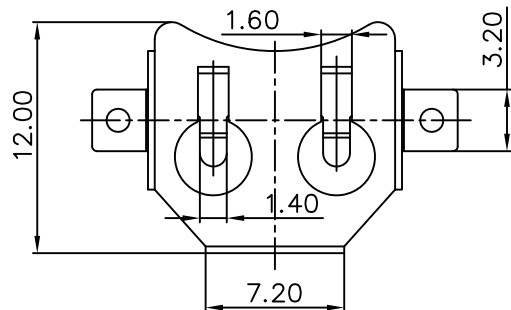

PCB Layout Diagram
Top View

工程部
2019-05-06
LQ. HUANG

技术要求:

- 1、截剪断面毛刺高度 $\leq 0.03\text{mm}$;
- 2、部件要求平整,无变形、裂纹、损伤等外观缺陷;

UNLESS OTHERWISE SPECIFIED TOLERANCES		MYOUNG 美阳 www.meiyangdz.com			
DECIMALS: X :±0.30 X.X :±0.25 X.XX :±0.20 X.XXX :±0.10	ANGLES: X :±1° X.X :±0.5°	DSND	YangFeng	DATE	2019-05-06
		CHKD	ZhouRuicai	DATE	2019-05-06
		APVD	XueShunyong	DATE	2019-05-06
WEIGHT: g		SCALE:	SIZE: A4	VIEW:	
SHEET 1 OF 1		UNIT: mm	REV.: A/1	OBJECT: MY	TITLE: 电池扣CR1220-W SMT
		PART NO.:		MY-1220-03	
		DRAW NO.:MY-CP-0210			

1	TERMINAL(+)	1	PHOSPHOR BRONZE, T=0.20mm	Ni-Plating
NO.	PART NAME	Q'TY	MATERIAL	PLATING & COLOR