

List

List..... 1

Package outline..... 2

Features..... 2

Mechanical data..... 2

Maximum ratings 2

Electrical characteristics..... 3~5

Rating and characteristic curves..... 6~7

Pinning information..... 8

Marking..... 8

Suggested solder pad layout..... 8

Suggested thermal profiles for soldering processes..... 9

High reliability test capabilities..... 10

SMAJ Series

400W Surface Mount Transient Voltage Suppressors- 5.0V- 440V

Package outline

Features

- 400W peak pulse power capability with a 10/1000 μ s waveform, repetition rate (duty cycle): 0.01%.
- Low profile surface mounted application in order to optimize board space.
- Excellent clamping capability.
- Low incremental surge resistance.
- Fast response time from 0V to VBR, typically less than 1 ps for uni-directional & 5 ns for bi-directional types.
- Glass passivated chip junction.
- Lead-free parts meet RoHS requirements.

Mechanical data

- Epoxy:UL94-V0 rated flame retardant
- Case : Molded plastic, DO-214AC / SMA
- Terminals : Solder plated, solderable per MIL-STD-750, Method 2026
- Polarity : Indicated by cathode band
- Mounting Position : Any
- Weight : Approximated 0.05 gram

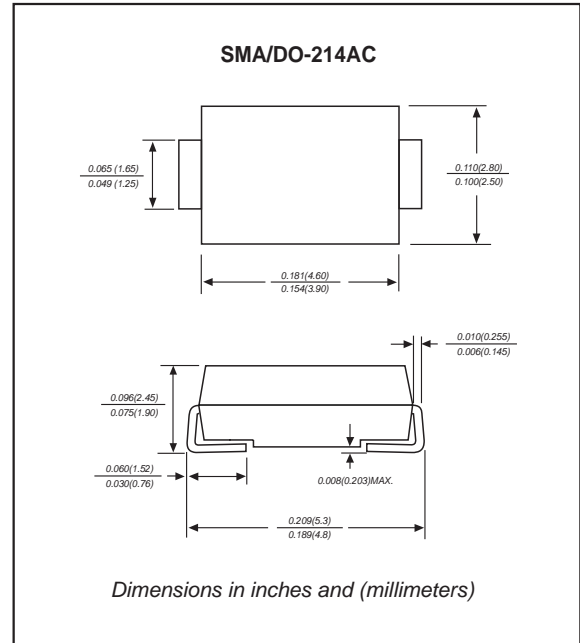

Maximum ratings (AT $T_A=25^{\circ}C$ unless otherwise noted)

PARAMETER	CONDITIONS	Symbol	Value	UNIT
Peak Power Dissipation	with a 10/1000 μ s waveform, Note 1, 2 & Fig. 1	P_{PPM}	400	W
Peak Pulse current	with a 10/1000 μ s waveform	I_{PPM}	See Table 1	A
Steady State Power Dissipation	at $T_C=75^{\circ}C$, Note 2	$P_{M(AV)}$	1.0	W
Peak Forward Surge Current	8.3ms Single Half Sine-Wave, Note 3	I_{FSM}	40	A
Maximum Instantaneous Forward Voltage	at 25A For Uni-Directional Types Only, Note 4	V_F	3.5/6.5	V
Operating Temperature		T_J	-55 ~ +150	$^{\circ}C$
Storage temperature		T_{STG}	-55 ~ +150	$^{\circ}C$

Note 1. Non-repetitive current pulse, per Fig. 3 and derated above $T_A=25^{\circ}C$ per Fig. 2
 2. Mounted on copper pad area of 0.2"x0.2" (5.0x5.0 mm) per Fig 5
 3. Measured on 8.3 ms single half sine-wave or equivalent square wave, duty cycle=4 pulses per minute maximum
 4. $V_F < 3.5V$ for $V_{BR} < 200V$ and $V_F < 6.5V$ for $V_{BR} > 201V$.

Electrical characteristics (at $T_A=25^{\circ}\text{C}$ unless otherwise noted)

Type Number		Marking		Reverse Stand-Off Voltage	Breakdown Voltage Min. @ I_T	Breakdown Voltage Max. @ I_T	Test Current	Maximum Clamping Voltage @ I_{PP}	Peak Pulse Current	Reverse Leakage @ V_{RMW}
(Uni)	(Bi)	(Uni)	(Bi)	$V_{RMW}(V)$	$V_{BR\ MIN}(V)$	$V_{BR\ MAX}(V)$	$I_T\ (mA)$	$V_C(V)$	$I_{PP}(A)$	$I_R(\mu A)$
SMAJ5.0	SMAJ5.0C	HD	TD	5.0	6.40	7.55	10.0	9.6	41.7	800.0
SMAJ5.0A	SMAJ5.0CA	HE	TE	5.0	6.40	7.25	10.0	9.2	43.5	800.0
SMAJ6.0	SMAJ6.0C	HF	TF	6.0	6.67	8.45	10.0	11.4	35.1	800.0
SMAJ6.0A	SMAJ6.0CA	HG	TG	6.0	6.67	7.67	10.0	10.3	38.8	800.0
SMAJ6.5	SMAJ6.5C	HH	TH	6.5	7.22	9.14	10.0	12.3	32.5	500.0
SMAJ6.5A	SMAJ6.5CA	HK	TK	6.5	7.22	8.30	10.0	11.2	35.7	500.0
SMAJ7.0	SMAJ7.0C	HL	TL	7.0	7.78	9.86	10.0	13.3	30.1	200.0
SMAJ7.0A	SMAJ7.0CA	HM	TM	7.0	7.78	8.95	10.0	12.0	33.3	200.0
SMAJ7.5	SMAJ7.5C	HN	TN	7.5	8.33	10.67	1.0	14.3	28.0	100.0
SMAJ7.5A	SMAJ7.5CA	HP	TP	7.5	8.33	9.58	1.0	12.9	31.0	100.0
SMAJ8.0	SMAJ8.0C	HQ	TQ	8.0	8.89	11.3	1.0	15.0	26.7	50.0
SMAJ8.0A	SMAJ8.0CA	HR	TR	8.0	8.89	10.23	1.0	13.6	29.4	50.0
SMAJ8.5	SMAJ8.5C	HS	TS	8.5	9.44	11.92	1.0	15.9	25.2	20.0
SMAJ8.5A	SMAJ8.5CA	HT	TT	8.5	9.44	10.82	1.0	14.4	27.8	20.0
SMAJ9.0	SMAJ9.0C	HU	TU	9.0	10.0	12.6	1.0	16.9	23.7	10.0
SMAJ9.0A	SMAJ9.0CA	HV	TV	9.0	10.0	11.5	1.0	15.4	26.0	10.0
SMAJ10	SMAJ10C	HW	TW	10	11.1	14.1	1.0	18.8	21.3	5.0
SMAJ10A	SMAJ10CA	HX	TX	10	11.1	12.8	1.0	17.0	23.5	5.0
SMAJ11	SMAJ11C	HY	TY	11	12.2	15.4	1.0	20.1	19.9	5.0
SMAJ11A	SMAJ11CA	HZ	TZ	11	12.2	14.0	1.0	18.2	22.0	5.0
SMAJ12	SMAJ12C	ID	UD	12	13.3	16.9	1.0	22.0	18.2	5.0
SMAJ12A	SMAJ12CA	IE	UE	12	13.3	15.3	1.0	19.9	20.1	5.0
SMAJ13	SMAJ13C	IF	UF	13	14.4	18.2	1.0	23.8	16.8	5.0
SMAJ13A	SMAJ13CA	IG	UG	13	14.4	16.5	1.0	21.5	18.6	5.0
SMAJ14	SMAJ14C	IH	UH	14	15.6	19.8	1.0	25.8	15.5	5.0
SMAJ14A	SMAJ14CA	IK	UK	14	15.6	17.9	1.0	23.2	17.2	5.0
SMAJ15	SMAJ15C	IL	UL	15	16.7	21.1	1.0	26.9	14.9	5.0
SMAJ15A	SMAJ15CA	IM	UM	15	16.7	19.2	1.0	24.4	16.4	5.0
SMAJ16	SMAJ16C	IN	UN	16	17.8	22.6	1.0	28.8	13.9	5.0
SMAJ16A	SMAJ16CA	IP	UP	16	17.8	20.5	1.0	26.0	15.4	5.0
SMAJ17	SMAJ17C	IQ	UQ	17	18.9	23.9	1.0	30.5	13.1	5.0
SMAJ17A	SMAJ17CA	IR	UR	17	18.9	21.7	1.0	27.6	14.5	5.0
SMAJ18	SMAJ18C	IS	US	18	20.0	25.3	1.0	32.2	12.4	5.0
SMAJ18A	SMAJ18CA	IT	UT	18	20.0	23.3	1.0	29.2	13.7	5.0
SMAJ20	SMAJ20C	IU	UU	20	22.2	28.1	1.0	35.8	11.2	5.0
SMAJ20A	SMAJ20CA	IV	UV	20	22.2	25.5	1.0	32.4	12.3	5.0

※ For Bi-directional type having VRWM of 10 Volts and less, the IR limit is double

Electrical characteristics (at $T_A=25^\circ\text{C}$ unless otherwise noted)

Type Number		Marking		Reverse Stand-Off Voltage	Breakdown Voltage Min. @ I_T	Breakdown Voltage Max. @ I_T	Test Current	Maximum Clamping Voltage @ I_{PP}	Peak Pulse Current	Reverse Leakage @ V_{RMW}
(Uni)	(Bi)	(Uni)	(Bi)	$V_{RMW}(V)$	$V_{BR\ MIN}(V)$	$V_{BR\ MAX}(V)$	$I_T\ (mA)$	$V_C(V)$	$I_{PP}(A)$	$I_R(\mu A)$
SMAJ22	SMAJ22C	IW	UW	22	24.4	30.9	1.0	39.4	10.2	5.0
SMAJ22A	SMAJ22CA	IX	UX	22	24.4	28.0	1.0	35.5	11.3	5.0
SMAJ24	SMAJ24C	IY	UY	24	26.7	33.8	1.0	43.0	9.3	5.0
SMAJ24A	SMAJ24CA	IZ	UZ	24	26.7	30.7	1.0	38.9	10.3	5.0
SMAJ26	SMAJ26C	JD	VD	26	28.9	36.6	1.0	46.6	8.6	5.0
SMAJ26A	SMAJ26CA	JE	VE	26	28.9	33.2	1.0	42.1	9.5	5.0
SMAJ28	SMAJ28C	JF	VF	28	31.1	39.4	1.0	50.0	8.0	5.0
SMAJ28A	SMAJ28CA	JG	VG	28	31.1	35.8	1.0	45.4	8.8	5.0
SMAJ30	SMAJ30C	JH	VH	30	33.3	42.2	1.0	53.5	7.5	5.0
SMAJ30A	SMAJ30CA	JK	VK	30	33.3	38.3	1.0	48.4	8.3	5.0
SMAJ33	SMAJ33C	JL	VL	33	36.7	46.5	1.0	59.0	6.8	5.0
SMAJ33A	SMAJ33CA	JM	VM	33	36.7	42.2	1.0	53.3	7.5	5.0
SMAJ36	SMAJ36C	JN	VN	36	40.0	50.7	1.0	64.3	6.2	5.0
SMAJ36A	SMAJ36CA	JP	VP	36	40.0	46.0	1.0	58.1	6.9	5.0
SMAJ40	SMAJ40C	JQ	VQ	40	44.4	56.3	1.0	71.4	5.6	5.0
SMAJ40A	SMAJ40CA	JR	VR	40	44.4	51.1	1.0	64.5	6.2	5.0
SMAJ43	SMAJ43C	JS	VS	43	47.8	60.5	1.0	76.7	5.2	5.0
SMAJ43A	SMAJ43CA	JT	VT	43	47.8	54.9	1.0	69.4	5.8	5.0
SMAJ45	SMAJ45C	JU	VU	45	50.0	63.3	1.0	80.3	5.0	5.0
SMAJ45A	SMAJ45CA	JV	VV	45	50.0	57.5	1.0	72.7	5.5	5.0
SMAJ48	SMAJ48C	JW	VW	48	53.3	67.5	1.0	85.5	4.7	5.0
SMAJ48A	SMAJ48CA	JX	VX	48	53.3	61.3	1.0	77.4	5.2	5.0
SMAJ51	SMAJ51C	JY	VY	51	56.7	71.8	1.0	91.1	4.4	5.0
SMAJ51A	SMAJ51CA	JZ	VZ	51	56.7	65.2	1.0	82.4	4.9	5.0
SMAJ54	SMAJ54C	RD	WD	54	60.0	76.0	1.0	96.3	4.2	5.0
SMAJ54A	SMAJ54CA	RE	WE	54	60.0	69.0	1.0	87.1	4.6	5.0
SMAJ58	SMAJ58C	RF	WF	58	64.4	81.6	1.0	103	3.9	5.0
SMAJ58A	SMAJ58CA	RG	WG	58	64.4	74.1	1.0	93.6	4.3	5.0
SMAJ60	SMAJ60C	RH	WH	60	66.7	84.5	1.0	107	3.7	5.0
SMAJ60A	SMAJ60CA	RK	WK	60	66.7	76.7	1.0	96.8	4.1	5.0
SMAJ64	SMAJ64C	RL	WL	64	71.1	90.1	1.0	114	3.5	5.0
SMAJ64A	SMAJ64CA	RM	WM	64	71.1	81.8	1.0	103	3.9	5.0
SMAJ70	SMAJ70C	RN	WN	70	77.8	98.6	1.0	125	3.2	5.0
SMAJ70A	SMAJ70CA	RP	WP	70	77.8	89.5	1.0	113	3.5	5.0
SMAJ75	SMAJ75C	RQ	WQ	75	83.0	105.7	1.0	134	3.0	5.0
SMAJ75A	SMAJ75CA	RR	WR	75	83.0	95.8	1.0	121	3.3	5.0
SMAJ78	SMAJ78C	RS	WS	78	86.0	109.8	1.0	139	2.9	5.0
SMAJ78A	SMAJ78CA	RT	WT	78	86.0	99.7	1.0	126	3.2	5.0

※ For Bi-directional type having VRWM of 10 Volts and less, the IR limit is double

Electrical characteristics (at $T_A=25^\circ\text{C}$ unless otherwise noted)

Type Number		Marking		Reverse Stand-Off Voltage	Breakdown Voltage Min. @ I_T	Breakdown Voltage Max. @ I_T	Test Current	Maximum Clamping Voltage @ I_{PP}	Peak Pulse Current	Reverse Leakage @ V_{RMW}
(Uni)	(Bi)	(Uni)	(Bi)	$V_{RMW}(V)$	$V_{BR\ MIN}(V)$	$V_{BR\ MAX}(V)$	$I_T\ (mA)$	$V_C(V)$	$I_{PP}(A)$	$I_R(\mu A)$
SMAJ85	SMAJ85C	RU	WU	85	94.0	119.2	1.0	151	2.6	5.0
SMAJ85A	SMAJ85CA	RV	WV	85	94.0	108.2	1.0	137	2.9	5.0
SMAJ90	SMAJ90C	RW	WW	90	100	126.5	1.0	160	2.5	5.0
SMAJ90A	SMAJ90CA	RX	WX	90	100	115.5	1.0	146	2.7	5.0
SMAJ100	SMAJ100C	RY	WY	100	111	141.0	1.0	179	2.2	5.0
SMAJ100A	SMAJ100CA	RZ	WZ	100	111	128.0	1.0	162	2.5	5.0
SMAJ110	SMAJ110C	SD	XD	110	122	154.5	1.0	196	2.0	5.0
SMAJ110A	SMAJ110CA	SE	XE	110	122	140.5	1.0	177	2.3	5.0
SMAJ120	SMAJ120C	SF	XF	120	133	169.0	1.0	214	1.9	5.0
SMAJ120A	SMAJ120CA	SG	XG	120	133	153.0	1.0	193	2.1	5.0
SMAJ130	SMAJ130C	SH	XH	130	144	182.5	1.0	231	1.7	5.0
SMAJ130A	SMAJ130CA	SK	XK	130	144	165.5	1.0	209	1.9	5.0
SMAJ150	SMAJ150C	SL	XL	150	167	211.5	1.0	268	1.5	5.0
SMAJ150A	SMAJ150CA	SM	XM	150	167	192.5	1.0	243	1.6	5.0
SMAJ160	SMAJ160C	SN	XN	160	178	226.0	1.0	287	1.4	5.0
SMAJ160A	SMAJ160CA	SP	XP	160	178	205.0	1.0	259	1.5	5.0
SMAJ170	SMAJ170C	SQ	XQ	170	189	239.5	1.0	304	1.3	5.0
SMAJ170A	SMAJ170CA	SR	XR	170	189	217.5	1.0	275	1.5	5.0
SMAJ180	SMAJ180C	SS	XS	180	200	253.8	1.0	321	1.2	5.0
SMAJ180A	SMAJ180CA	ST	XT	180	200	230.4	1.0	290	1.4	5.0
SMAJ190	SMAJ190C	SU	XU	190	211	267.9	1.0	339	1.2	5.0
SMAJ190A	SMAJ190CA	SV	XV	190	211	243.2	1.0	306	1.3	5.0
SMAJ200	SMAJ200C	SW	XW	200	222	282.0	1.0	356	1.1	5.0
SMAJ200A	SMAJ200CA	SX	XX	200	222	256.0	1.0	322	1.2	5.0
SMAJ210	SMAJ210C	SY	XY	210	233	296.1	1.0	375	1.1	5.0
SMAJ210A	SMAJ210CA	SZ	XZ	210	233	268.8	1.0	339	1.2	5.0
SMAJ220	SMAJ220C	ZD	YD	220	244	310.2	1.0	392	1.0	5.0
SMAJ220A	SMAJ220CA	ZE	YE	220	244	281.6	1.0	355	1.1	5.0
SMAJ250	SMAJ250C	ZF	YF	250	278	342.5	1.0	447	0.9	5.0
SMAJ250A	SMAJ250CA	ZG	YG	250	278	309.0	1.0	403	1.0	5.0
SMAJ300	SMAJ300C	ZH	YH	300	333	411.0	1.0	535	0.7	5.0
SMAJ300A	SMAJ300CA	ZK	YK	300	333	371.0	1.0	484	0.8	5.0
SMAJ350	SMAJ350C	ZL	YL	350	389	479.5	1.0	624	0.6	5.0
SMAJ350A	SMAJ350CA	ZM	YM	350	389	432.0	1.0	565	0.7	5.0
SMAJ400	SMAJ400C	ZN	YN	400	444	548.0	1.0	687	0.6	5.0
SMAJ400A	SMAJ400CA	ZP	YP	400	444	494.0	1.0	645	0.6	5.0
SMAJ440	SMAJ440C	ZQ	YQ	440	489	602.8	1.0	786	0.5	5.0
SMAJ440A	SMAJ440CA	ZR	YR	440	489	543.0	1.0	710	0.6	5.0

※ For Bi-directional type having VRWM of 10 Volts and less, the IR limit is double

Rating and characteristic curves (SMAJ SERIES)

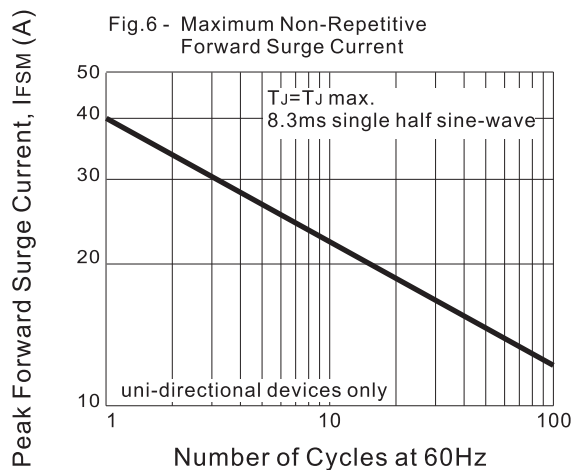
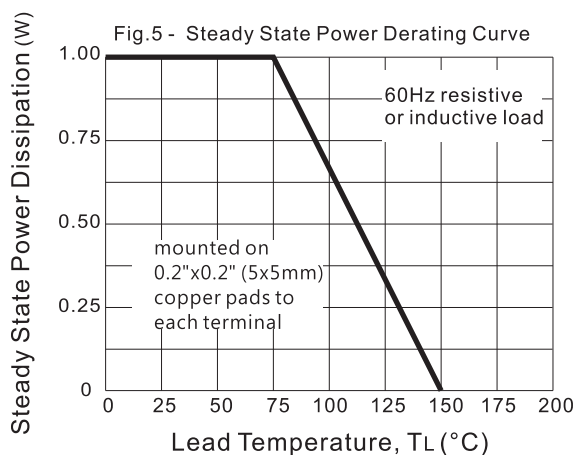
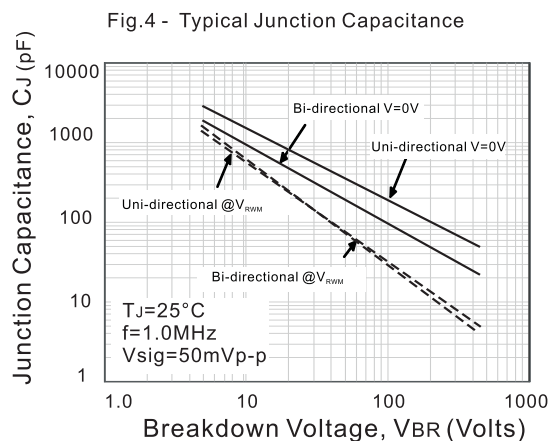
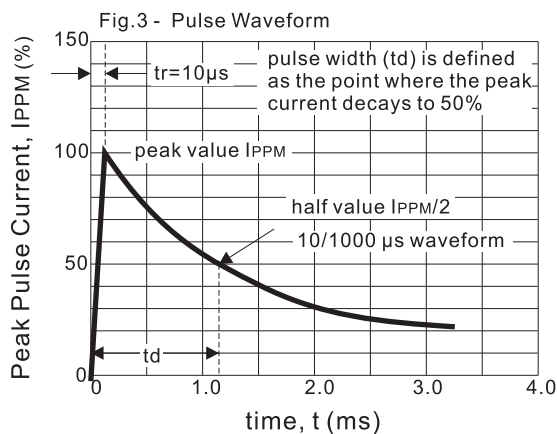
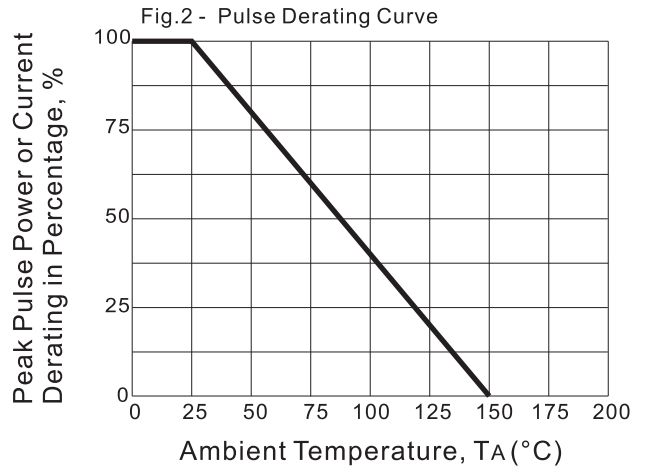
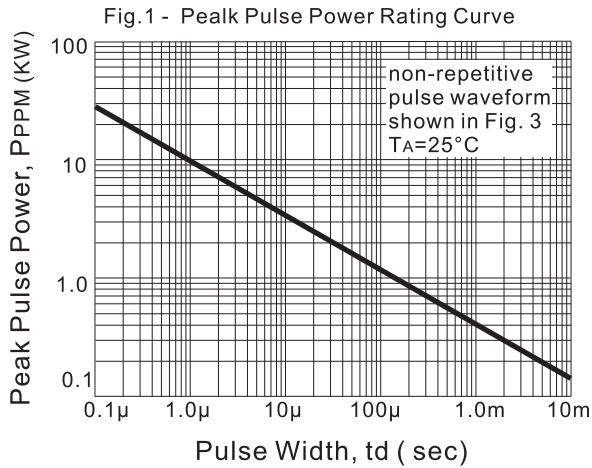

Rating and characteristic curves (SMAJ SERIES)

Fig. 7 - Transients of several thousand volts can be clamped to a safe level by the TVS

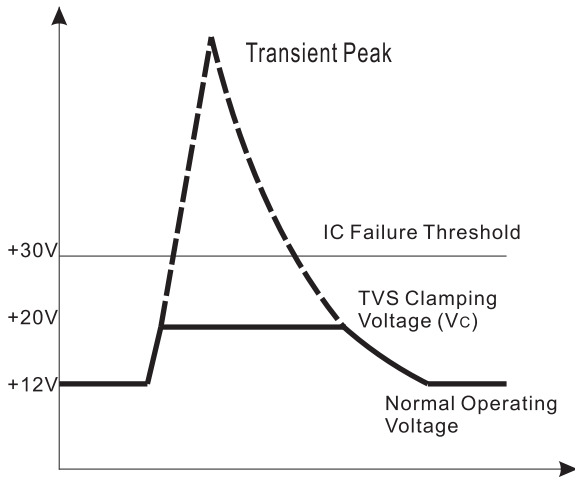
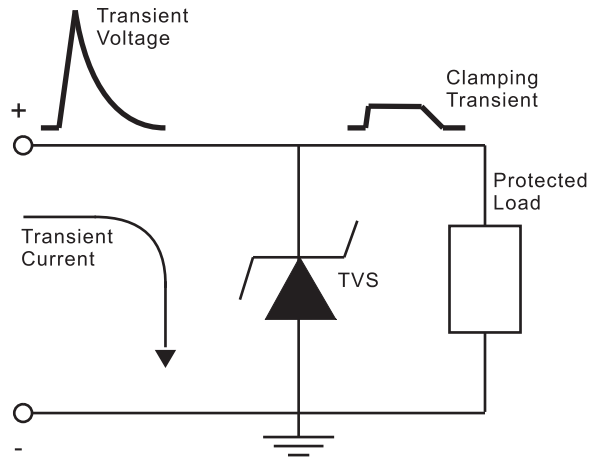





Fig. 8 - Transient current is diverted to ground thru TVS; the voltage seen by the protected load is limited to the clamping voltage level





SMAJ Series

Pinning information

Pin	Simplified outline	Symbol
Uni-Directional Pin1 cathode Pin2 anode		
Bi-Directional		

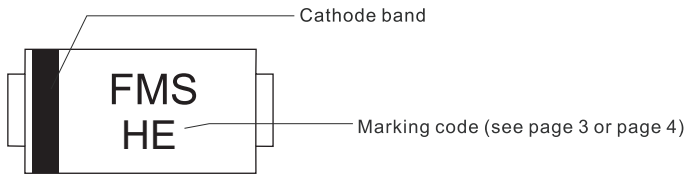
Marking

Type number	Example
Uni-Directional	
Bi-Directional	

Suggested solder pad layout

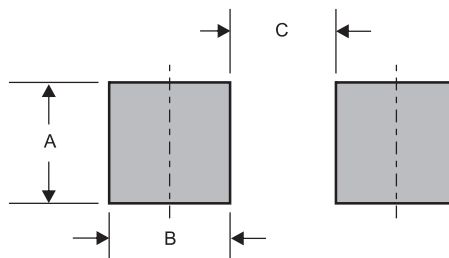

Dimensions in inches and (millimeters)

PACKAGE	A	B	C
SMA	0.063 (1.60)	0.059 (1.50)	0.110 (2.80)

Suggested thermal profiles for soldering processes

- 1.Storage environment: Temperature=5°C~40°C Humidity=55%±25%
- 2.Reflow soldering of surface-mount devices

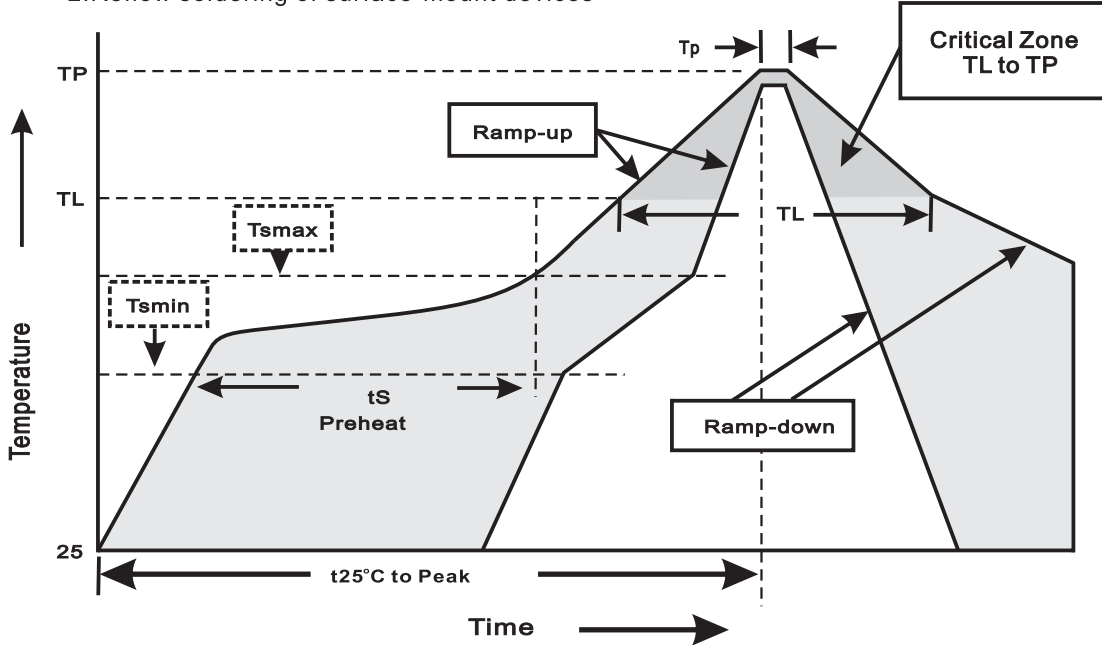

3.Reflow soldering

Profile Feature	Soldering Condition
Average ramp-up rate(T _L to T _P)	<3°C/sec
Preheat -Temperature Min(T _{smmin}) -Temperature Max(T _{smmax}) -Time(min to max)(t _s)	150°C 200°C 60~120sec
T _{smmax} to T _L -Ramp-upRate	<3°C/sec
Time maintained above: -Temperature(T _L) -Time(t _L)	217°C 60~260sec
Peak Temperature(T _P)	255°C-0/+5°C
Time within 5°C of actual Peak Temperature(t _P)	10~30sec
Ramp-down Rate	<6°C/sec
Time 25°C to Peak Temperature	<6minutes

High reliability test capabilities

Item Test	Conditions	Reference
1. Solder Resistance	at $260\pm 5^{\circ}\text{C}$ for $10\pm 2\text{sec}$. immerse body into solder $1/16''\pm 1/32''$	MIL-STD-750D METHOD-2031
2. Solderability	at $245\pm 5^{\circ}\text{C}$ for 5 sec.	MIL-STD-202F METHOD-208
3. High Temperature Reverse Bias	$V_{\text{RWM}}=80\%$ rate at $T_{\text{J}}=150^{\circ}\text{C}$ for 168 hrs.	MIL-STD-750D METHOD-1038
4. Pressure Cooker	$15P_{\text{SIG}}$ at $T_{\text{A}}=121^{\circ}\text{C}$ for 4 hrs.	JESD22-A102
5. Temperature Cycling	-55°C to $+125^{\circ}\text{C}$ dwelled for 30 min. and transferred for 5min. total 10 cycles.	MIL-STD-750D METHOD-1051
6. Thermal Shock	0°C for 5 min. rise to 100°C for 5 min. total 10 cycles.	MIL-STD-750D METHOD-1056
7. Humidity	at $T_{\text{A}}=85^{\circ}\text{C}$, RH=85% for 1000hrs.	MIL-STD-750D METHOD-1021
8. High Temperature Storage Life	at 175°C for 1000 hrs.	MIL-STD-750D METHOD-1031