

SynQor®

MQME-270-P Passive Filter

HIGH RELIABILITY EMI FILTER

-400V to +400V Continuous Input	2A Output Current	1.6Ω @ 125°C Max. DC Resistance	>80dB @ 500kHz Differential Attenuation
------------------------------------	----------------------	------------------------------------	--

FULL POWER OPERATION: -55°C TO +125°C

The MilQor® series of high-reliability EMI filters brings SynQor's field proven technology and manufacturing expertise to the Military/Aerospace industry. SynQor's innovative QorSeal™ packaging approach ensures survivability in the most hostile environments. Compatible with the industry standard format, these filters have high differential-mode and common-mode attenuation, low DC resistance, and a stabilizing bulk capacitor resistor. They follow conservative component derating guidelines and they are designed and manufactured to comply with a wide range of military standards

MilQor®

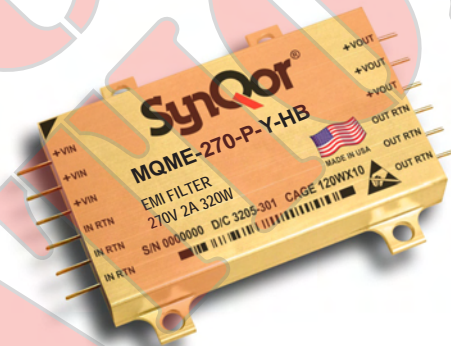

DESIGNED & MANUFACTURED IN THE USA
FEATURING QORSEAL™ HI-REL ASSEMBLY

Design Process

MQME series filters are:

- Designed for reliability per NAVSO-P3641-A guidelines
- Designed with components derated per:
 - MIL-HDBK-1547A
 - NAVSO P-3641A

Qualification Process

MQME series filters are qualified to:

- MIL-STD-810F
 - consistent with RTCA/DO-160E
- SynQor's First Article Qualification
 - consistent with MIL-STD-883F
- SynQor's Long-Term Storage Survivability Qualification
- SynQor's on-going life test

In-Line Manufacturing Process

- AS9100 and ISO 9001:2000 certified facility
- Full component traceability
- Temperature cycling
- Constant acceleration
- 24, 96, 160 hour burn-in
- Three level temperature screening

Features

- 2A output current
- Very low DC resistance
- > 80dB differential-mode attenuation at 500kHz
- > 60dB common-mode attenuation at 500kHz
- Stabilizing bulk capacitor and damping resistor included
- All capacitors are X7R multi-layer ceramic
- Designed to meet all MIL-STD 461 EMI and most RTCA/DO-160E Section 22 lightning requirements

Specification Compliance

MQME series filters (with MQFL converters) are designed to meet:

- MIL-HDBK-704-8 (A through F)
- RTCA/DO-160E Section 16
- MIL-STD-1275B
- DEF-STAN 61-5 (part 6)/5
- MIL-STD-461 (C, D, E)
- RTCA/DO-160E Section 22

BLOCK DIAGRAM

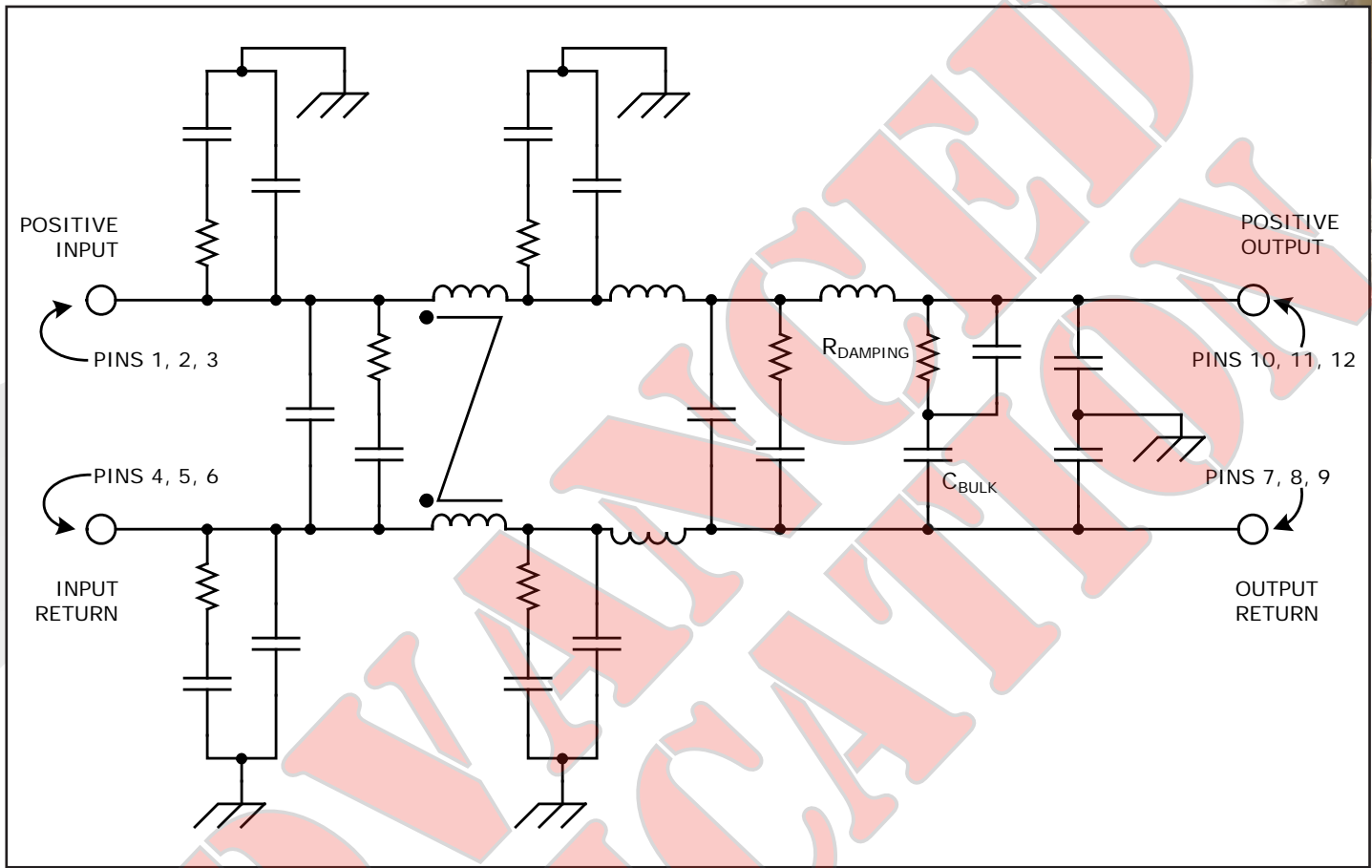

TYPICAL CONNECTION DIAGRAM

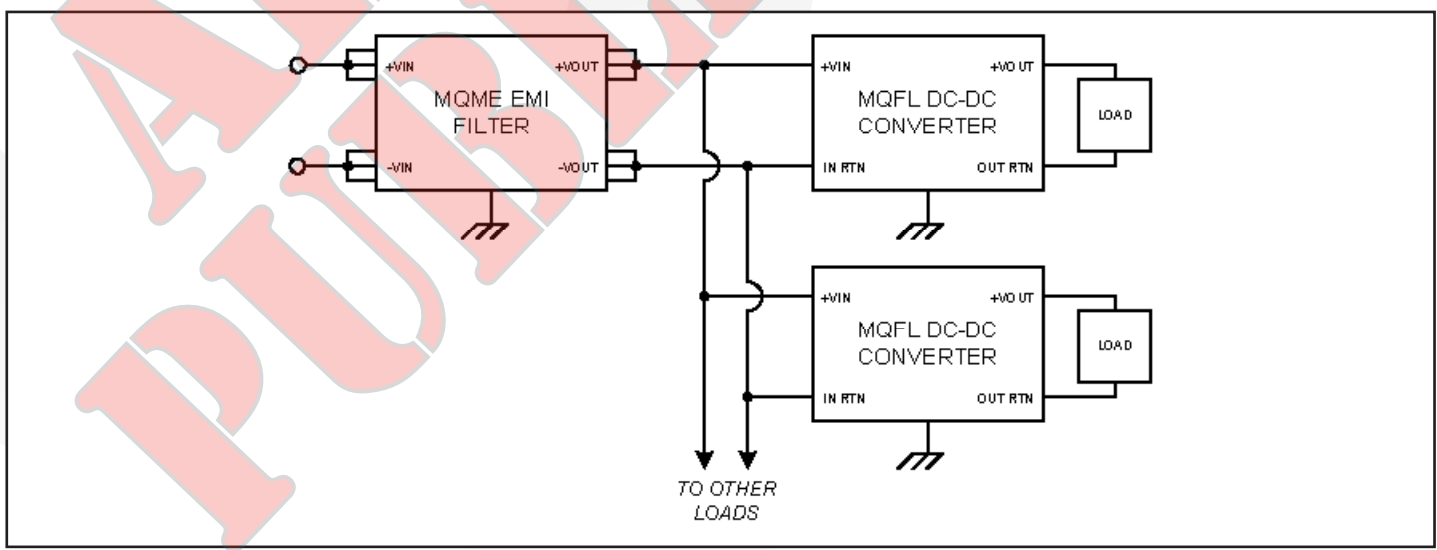



Technical Specification

MQME-270-P
Current: 2A

MQME-270-P Electrical Characteristics

Parameter	Min.	Typ.	Max.	Units	Notes & Conditions	Group A Subgroup ³
ABSOLUTE MAXIMUM RATINGS						
Input Voltage					See Note 1	
Continuous	-800		800	V		
Transient (≤ 1 s)	-1000		1000	V		
Isolation Voltage (I/O to case, I to O)						
Continuous	-500		500	V		
Transient (≤ 1 s)	-1000		1000	V		
Output Current			3	A		
Operating Case Temperature	-55		125	$^{\circ}$ C		
Storage Case Temperature	-65		135	$^{\circ}$ C		
Lead Temperature (20 s)			300	$^{\circ}$ C		
ELECTRICAL CHARACTERISTICS						
Input Voltage						
Continuous	-400		400	V	See Note 1 for negative limits	1, 2, 3
Transient (≤ 1 s, $R_S^* = 0 \Omega$)	-500		500	V	"	
Transient (≤ 100 ms, $R_S^* = 0 \Omega$)	-1000		1000	V	See Note 1	
Output Voltage (continuous)	$V_{out} = V_{in} - (I_{in} \times R_{dc})$			V		1, 2, 3
Output Current (continuous)			2	A		1, 2, 3
DC Resistance RDC						
TCASE = 25 $^{\circ}$ C			1.2	Ω		1
TCASE = 125 $^{\circ}$ C			1.6	Ω		3
Power Dissipation (2A output current)						
TCASE = 25 $^{\circ}$ C			4.8	W		
TCASE = 125 $^{\circ}$ C			6.4	W		1, 2, 3
Total Differential-Mode Capacitance		1		μ F	Measured across input or output pins	
Total Common-Mode Capacitance		0.44		μ F	Measured between any pin to case	
Bulk Capacitor		0.8		μ F		
Damping Capacitor		20		Ω		
Noise Attenuation					See Figure 1	
INPUT VOLTAGE SPIKE SUPPRESSION						
Output Voltage Deviation due to a Spike 2						
Input Voltage Spike (Centered on V_{in})						
± 200 V, 10 μ s, $R_s \leq 0.5 \Omega$ $ Q \leq 250 \mu$ C	-50		150	Δ V	MIL-STD-461C (CS06)	
± 600 V, 10 μ s, $R_s = 50 \Omega$	-50		150	Δ V	MIL-STD-461C (CS06)	
ISOLATION CHARACTERISTICS						
Isolation Voltage (any pin to case)						
Continuous	-500		500	V		1
Transient ($\leq 100 \mu$ s)	-800		800	V		
Isolation Resistance (any pin to case)	100			M Ω		1



Technical Specification



MQME-270-P
Current: 2A

MQME-270-P Electrical Characteristics (Continued)

Parameter	Min.	Typ.	Max.	Units	Notes & Conditions	Group A Subgroup ³
RELIABILITY CHARACTERISTICS						
Calculated MTBF (MIL-STD-217F2)					$V_{in}=270V\ DC \pm 5\%$, $I_{out}= 2A$ unless otherwise specified	
GB @ Tcase = 70°C		TBD		10 ⁶ Hrs.		
AIF @ Tcase = 70°C		TBD		10 ⁶ Hrs.		
Demonstrated MTBF		TBD		10 ⁶ Hrs.		

WEIGHT CHARACTERISTICS						
Device Weight		79		g		

Electrical Characteristics Notes

1. While the filter will survive these input voltage limits, the filter's output voltage will be outside the limits for an MQFL converter input voltage range.
2. Verified by qualification testing and analysis.
3. Only the ES and HB grade products are tested at three temperatures. The B and C grade products are tested at one temperature. Please refer to the Construction and Environmental Stress Screening Options table for details.

* R_s = Source Impedance

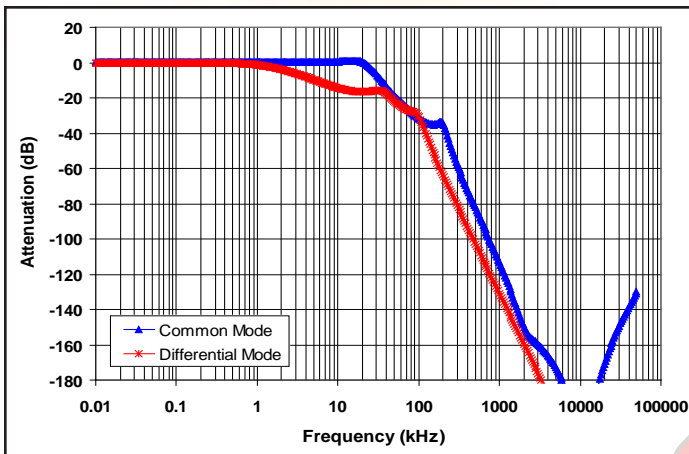

Figure 1: Typical Common Mode and Differential Mode Attenuation provided by the filter as a function of frequency. Both input lines are connected to chassis ground through 50ohm resistors. The filter case is also connected to chassis ground.

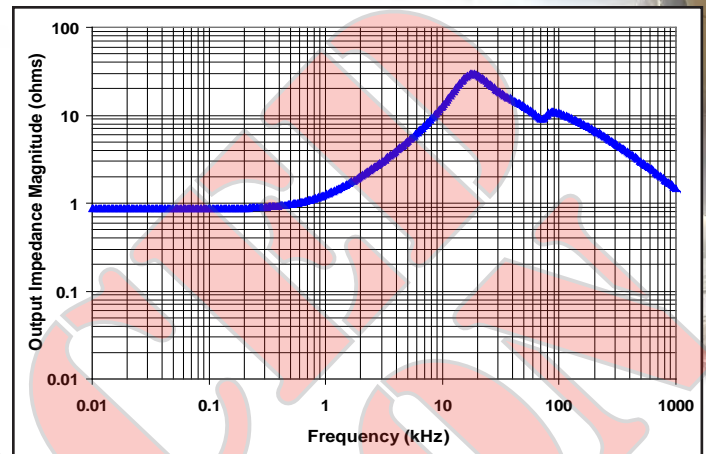

Figure 2: Typical Output Impedance (magnitude) of the filter looking back into its output pins with the input pins connected to a source with zero source impedance.

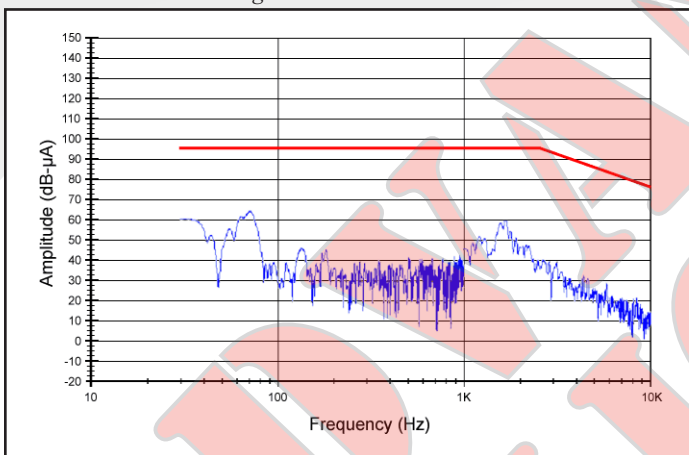

Figure 3: MIL-STD-461E Method CE101 Low Frequency Conducted Emissions. Limit line (in red) is the 'Submarine Applications DC Curve'.

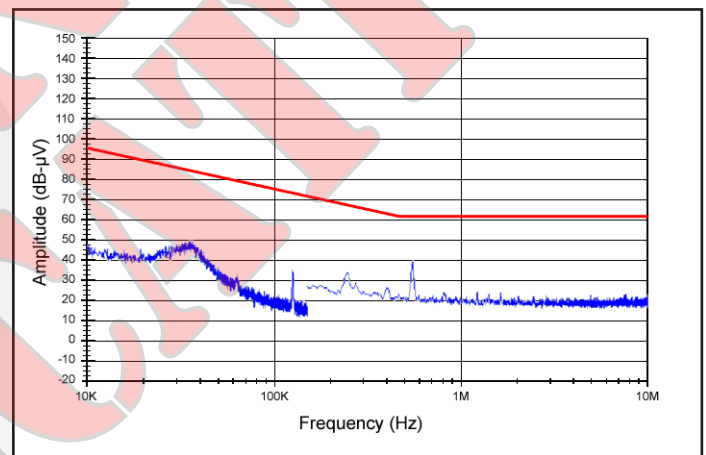

Figure 4: MIL-STD-461E Method CE102 High Frequency Conducted Emissions. Limit line (in red) is the 'Basic Curve'.

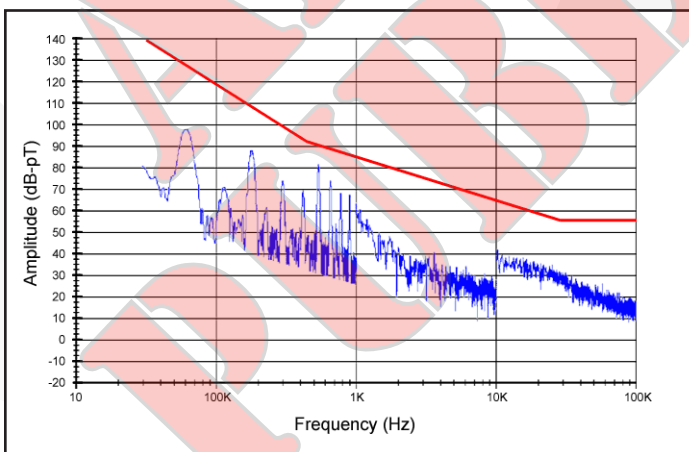

Figure 5: MIL-STD-461E Method RE101 Low Frequency Radiated Emissions. Limit line (in red) is the 'Standard Curve' from MIL-STD-461C Method RE01, which is more strict than all RE101 limits.

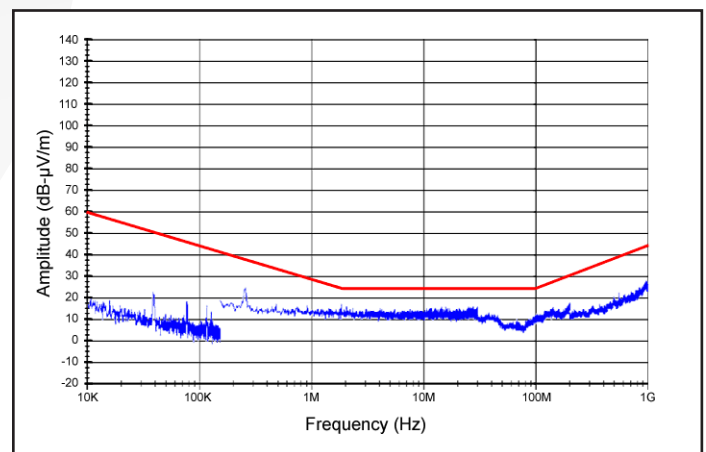

Figure 6: MIL-STD-461E Method RE102 High Frequency Radiated Emissions. Limit line (in red) is the 'Submarine External to Pressure Hull Curve'.

BASIC OPERATION AND FEATURES

The MQME-270-P is a multi-stage differential-mode and common-mode passive EMI filter designed to interface a power source with one or more SynQor DC/DC converters (or other loads that create EMI). Each stage of this filter is well damped to avoid resonances and oscillations, and only X7R multi-layer ceramic capacitors are used. Figure 1 shows the typical differential and common-mode attenuation provided by this filter when the source impedance is 50Ω to chassis ground on each input line.

The MQME-270-P EMI filter includes a large bulk capacitor (also X7R) with a series damping resistor to correct for the unstabilizing effect of a converter's negative input resistance. A white paper discussing this negative input resistance and the need for corrective damping can be found on the SynQor website (see Input System Instability application note). Figure 2 shows the magnitude of the filter's output impedance when the filter input is connected to a stiff voltage source.

The input voltage surge and spike compliance matrix shown on Page 8 displays the worst case requirements listed in various 270V Military (Vehicle and Aircraft) and Civil Aircraft standards. The MQME-270-P EMI filter is designed to handle all of the short duration voltage spike requirements of these standards (with certain assumptions regarding DEF-STAN 61-5). Some of the long duration voltage surge requirements remain within the 50V maximum transient rating of a SynQor MQFL-270 DC/DC converter. The others require the transient suppression circuitry of an MQME-270-T EMI filter to protect the converter from an over-voltage condition. If MQFL-270E or MQFL-270VE converters are used, voltage surges as high as 80V can be tolerated without the need for this transient suppression circuitry.

When used with SynQor's DC/DC converters, the MQME-270-P EMI filter is designed to pass all of the relevant MIL-STD-461C/D/E requirements to their most stringent limits. The MIL-STD-461 Compliance Matrix Table on Page 7 lists these requirements and describes the setup used to pass them. Figures 3 - 6 show results from selected conductive and radiated emissions tests.

The filter is also designed to pass the waveform types and applications specified in RTCA/DO-160E Section 22 (Lightning Induced Transient Susceptibility) to Level 4 (some waveforms/applications require the MQME-270-T filter and/or external transient suppression circuitry). The Section 22 Compliance Matrix Table on Page 9 lists these waveforms and applications and describes the setup used to pass them.

A typical application would place the MQME filter close to the input of the DC/DC converter, with the cases of the filter and the converter connected together through a ground plane. Both cases are electrically conductive, so connection to the cases can be made with the fasteners used to secure the device.

Do not connect the outputs of multiple MQME-270-P filters in parallel. Connecting filters in this manner may result in slightly unequal currents to flow in the positive and return paths of each filter. These unequal currents may cause the internal common-mode chokes to saturate and thus cause degraded common-mode rejection performance.

MIL-STD-461 COMPLIANCE MATRIX

This table shows the MIL-STD-461 requirements/limits that have been met* by a stand-alone setup comprised of:

- MilQor-270-P Filter
- MQFL-28-05S DC/DC Converter
- 120W Resistive Load
- Metal Chassis Plane

	-461 C		-461 D/E	
	Requirement	Most Stringent Limit Listed	Requirement	Most Stringent Limit Listed
Conducted Emissions	CE01 CE03 CE07	Class A5 (Submarine) Class A5 (Submarine) Class A1 (Aircraft)	CE101 CE102	Submarine Basic Curve
Conducted Susceptibility	CS01 CS02	Class A5 (Submarine) Class A5 (Submarine)	CS101 CS114 CS115 CS116	Curve #2 Curve #5 Basic Waveform Imax = 10 A
	CS06	Class A1/A5 (Aircraft/Sub)		
	CS10 CS11	Class A5 (Submarine) Class A5 (Submarine)		
Radiated Emissions	RE01 RE02†	Class A5 (Submarine) Class A5 (Submarine)	RE101 RE102†	Navy Submarine
Radiated Susceptibility	RS01 RS02 RS03	Class A5 (Submarine) Class A1/A5 (Aircraft/Sub) Class A4 (Surface Ship)	RS101 RS103	Army Aircraft External

Met by any MQME Filter

Met by an MQME Filter having the
Transient Suppression and Reverse
Polarity Protection Features

* Susceptibility requirements/limits are deemed to have been met as long as transient deviations in the converter's output voltage remain within $\pm 10\%$ of its initial value.

† Met with metal screen shield covering the filter, converter, and resistive load.

RTCA/DO-160E SECTION 22 COMPLIANCE MATRIX (LIGHTNING INDUCED TRANSIENT SUSCEPTIBILITY)

The following table shows the RTCA/DO-160 Section 22 requirements that have been met* by a stand-alone setup comprised of:

- MilQor-270-P (or -T) Filter
- MQFL-28-05S DC/DC Converter
- Resistive Load
- Metal Chassis Plane
- Unshielded Power Cable Bundle

	Waveform	Maximum Level Passed	Test Conditions
Pin Injection	3	4	Signal applied to +Vin pin. Input Return pin connected to system ground
	4	4†	
	5a	4†	
Single- and Multiple-Stroke Cable Induction	2	4**	Signal applied to unshielded power cable bundle
	3	4	
Single- and Multiple-Stroke Ground Injection	4	4	Signal applied between metal ground plane and system ground
	5a	4	
Multiple-Burst Cable Induction	3	4	Signal applied to unshielded power cable bundle

Met by any MQME Filter	Met by an MQME Filter having the Transient Suppression and Reverse Polarity Protection Features
------------------------	---

* Requirement is deemed to have been met as long as transient deviations in the converter's output voltage remain within $\pm 10\%$ of its initial value.

† For these waveforms at Level 3 and above, an external transient suppressor of sufficient energy rating must be placed across the filter's input pins to keep the differential transient input voltage below $+200V/-50V$. Negative polarity waveforms may cause power flow to the converter to be interrupted long enough to cause a graceful shutdown and restart of the converter. Also, the reverse voltage protection feature of the -T filter is required to protect the converter (but not the filter) from negative polarity waveform.

** For this waveform at a Level 4 and above, external transient suppressors of sufficient energy rating must be added between the filter's input power pins and its case to keep the common-mode transient input voltage below $\pm 800V$.

VOLTAGE SURGE AND SPIKE COMPLIANCE MATRIX

These tables show the Voltage Surge and Spike requirements/limits that have been met* by a stand-alone setup comprised of:

- MilQor-270-P (or -T) Filter
- MQFL-28-05S DC/DC Converter
- 120W Resistive Load
- Metal Chassis Plane

Vehicle 28Vin	Worst Case Over-Voltage Surge (Voltage/Duration)	Short Duration Spikes (Voltage/Duration/Impedance)
MIL-STD-1275B (Gen.+Bat.)	40V / 50ms	±250V / 15mJ / 0.5W
MIL-STD-1275B (Bat. Only)	100V / 50ms	±250V / 15mJ / 0.5W
MIL-STD-1275B (Gen. Only)	100V / 50ms	±250V / 15mJ / 0.5W
DEF STAN 61-5 (PART 6)† (Gen.+Bat.)	40V / 50ms	+130V/-100V max
	+70V/-40V / 5ms	+90V/-60V / 10µs
DEF STAN 61-5 (PART 6)† (Bat. Only, Regen. Ld. Sw.)	40V / 50ms	+130V/-100V max
	+70V/-40V / 5ms	+90V/-60V / 10µs
DEF STAN 61-5 (PART 6)† (Bat. Only, Non-Regen. Ld. Sw.)	100V / 80ms	+130V/-100V max
	+70V/-40V / 5ms	+90V/-60V / 10µs
DEF STAN 61-5 (PART 6)† (Gen. Only)	100V / 80ms	+280V/-220V max
	+110V/-50V / 5ms	+130V/-70V / 10µs

Aircraft 28Vin	Worst Case Over-Voltage Surge (Voltage/Duration)	Short Duration Spikes (Voltage/Duration/Impedance)
MIL-HDB K-704-8 (704A)	80V / 50ms	N/A
	60V / 50ms	
MIL-HDB K-704-8 (704B)	50V / 50ms	N/A
MIL-HDB K-704-8 (704C)	50V / 50ms	N/A
MIL-HDB K-704-8 (704D)	50V / 50ms	N/A
MIL-HDB K-704-8 (704E)	50V / 50ms	N/A
MIL-HDB K-704-8 (704F)	50V / 50ms	N/A
RT CA/DO-160E (Cat A)	47V / 100ms	±600V / 10µs / 50W
	38V / 1 sec	
RT CA/DO-160E (Cat B)	60V / 100ms	±200V / 10µs / 50W
	40V / 1 sec	
RT CA/DO-160E (Cat Z)	80V / 100ms	N/A
	48V / 1 sec	

Met by any MQME Filter	Met by an MQME Filter having the Transient Suppression and Reverse Polarity Protection Features
------------------------	---

* Surge/spike requirements/limits are deemed to have been met as long as transient deviations in the converter's output voltage remain within ±10% of its initial value.

† For the DEF STAN 61-5 specification:

- 1) Negative surges require reverse voltage protection circuitry to protect the converter (but not the filter) from a negative input. This circuitry is included in the MilQor-28-T and MilQor-28-HT filters but not the MilQor-270-P filter.
- 2) The negative surges may cause the converter to shut down unless additional holdup capacitance is included.
- 3) Maximum spike voltages are assumed to last < 1µs.

CONSTRUCTION AND ENVIRONMENTAL STRESS SCREENING OPTIONS

Screening	Consistent with MIL-STD-883F	C-Grade (-40 °C to +100 °C)	ES-Grade (-55 °C to +125 °C) (Element Evaluation)	HB-Grade (-55 °C to +125 °C) (Element Evaluation)
Internal Visual	*	Yes	Yes	Yes
Temperature Cycle	Method 1010	No	Condition B (-55 °C to +125 °C)	Condition C (-65 °C to +150 °C)
Constant Acceleration	Method 2001 (Y1 Direction)	No	500g	Condition A (5000g)
Burn-in	Method 1015 Load Cycled • 10s period • 2s @ 100% Load • 8s @ 0% Load	24 Hrs @ +125 °C	96 Hrs @ +125 °C	160 Hrs @ +125 °C
Final Electrical Test	Method 5005 (Group A)	+25 °C	-45, +25, +100 °C	-55, +25, +125 °C
Mechanical Seal, Thermal, and Coating Process		Full QorSeal	Full QorSeal	Full QorSeal
External Visual	2009	*	Yes	Yes
Construction Process		QorSeal	QorSeal	QorSeal
* Per IPC-A-610 (Rev. D) Class 3				

MilQor converters and filters are offered in four variations of construction technique and environmental stress screening options. The three highest grades, C, ES, and HB, all use SynQor's proprietary QorSeal™ Hi-Rel assembly process that includes a Parylene-C coating of the circuit, a high performance thermal compound filler, and a nickel barrier gold plated aluminum case. Each successively higher grade has more stringent mechanical and electrical testing, as well as a longer burn-in cycle. The ES- and HB-Grades are also constructed of components that have been procured through an element evaluation process that pre-qualifies each new batch of devices.

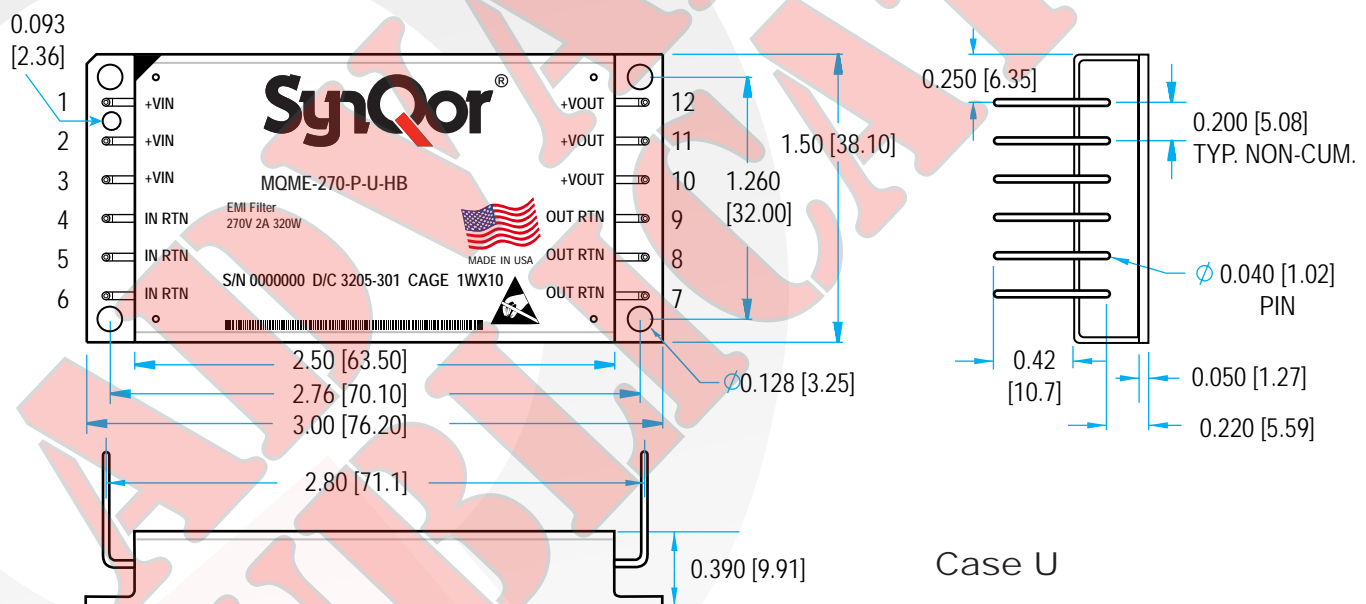
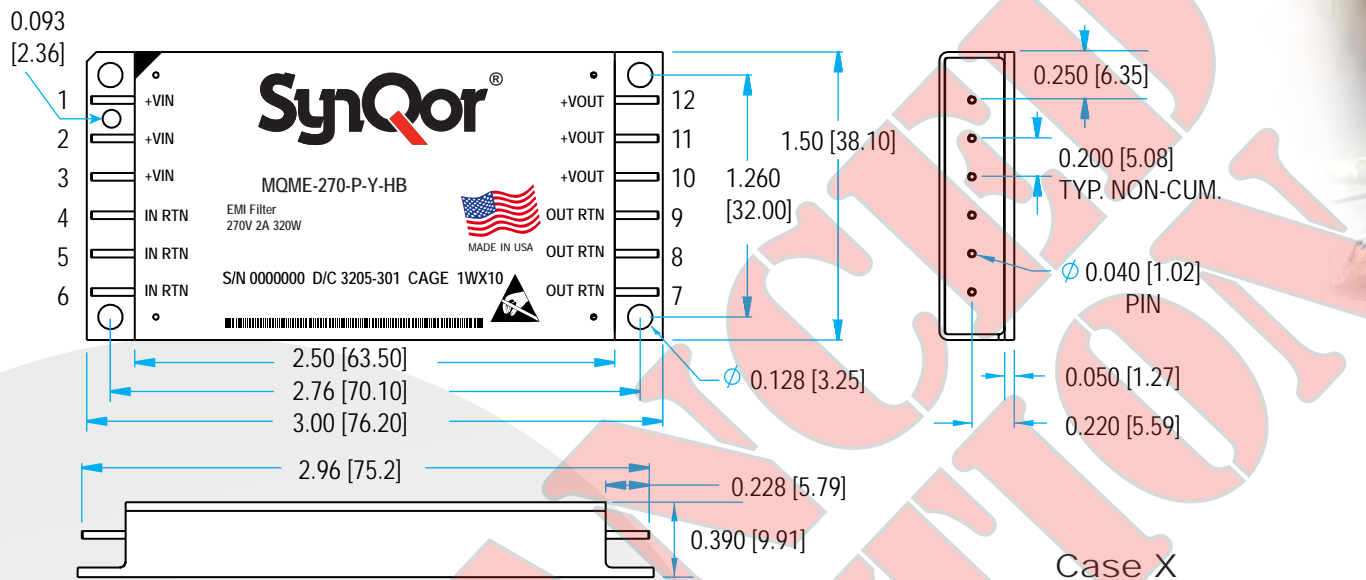

NOTES

- 1) Pins 0.040" (1.02mm) diameter
- 2) Pins Material: Copper
Finish: Gold over Nickel plate
- 3) All dimensions in inches (mm) Tolerances: x.xx +/-0.02 in. (x.x +/-0.5mm)
x.xxx +/-0.010 in. (x.xx +/-0.25mm)
- 4) Weight: 2.8 oz (78.5 g) typical
- 5) Workmanship: Meets or exceeds IPC-A-610C Class III
- 6) Print Labeling on Top Surface per Product Label Format Drawing

PIN DESIGNATIONS

Pin	Function	Pin	Function
1	Positive input	7	Output return
2	Positive input	8	Output return
3	Positive input	9	Output return
4	Input return	10	Positive output
5	Input return	11	Positive output
6	Input return	12	Positive output

Technical Specification

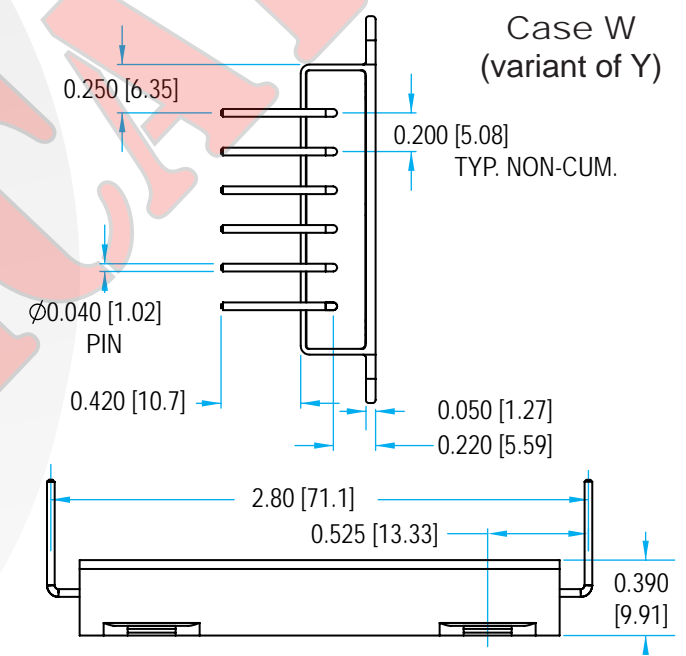
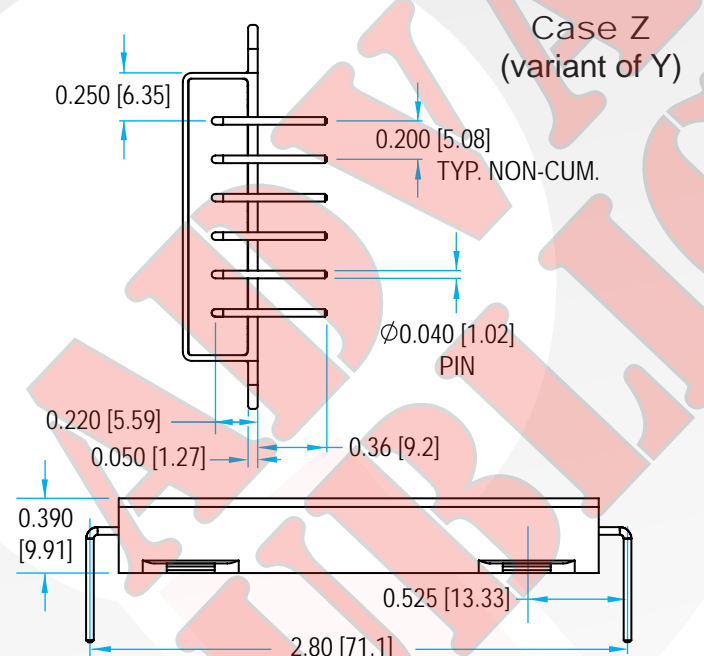
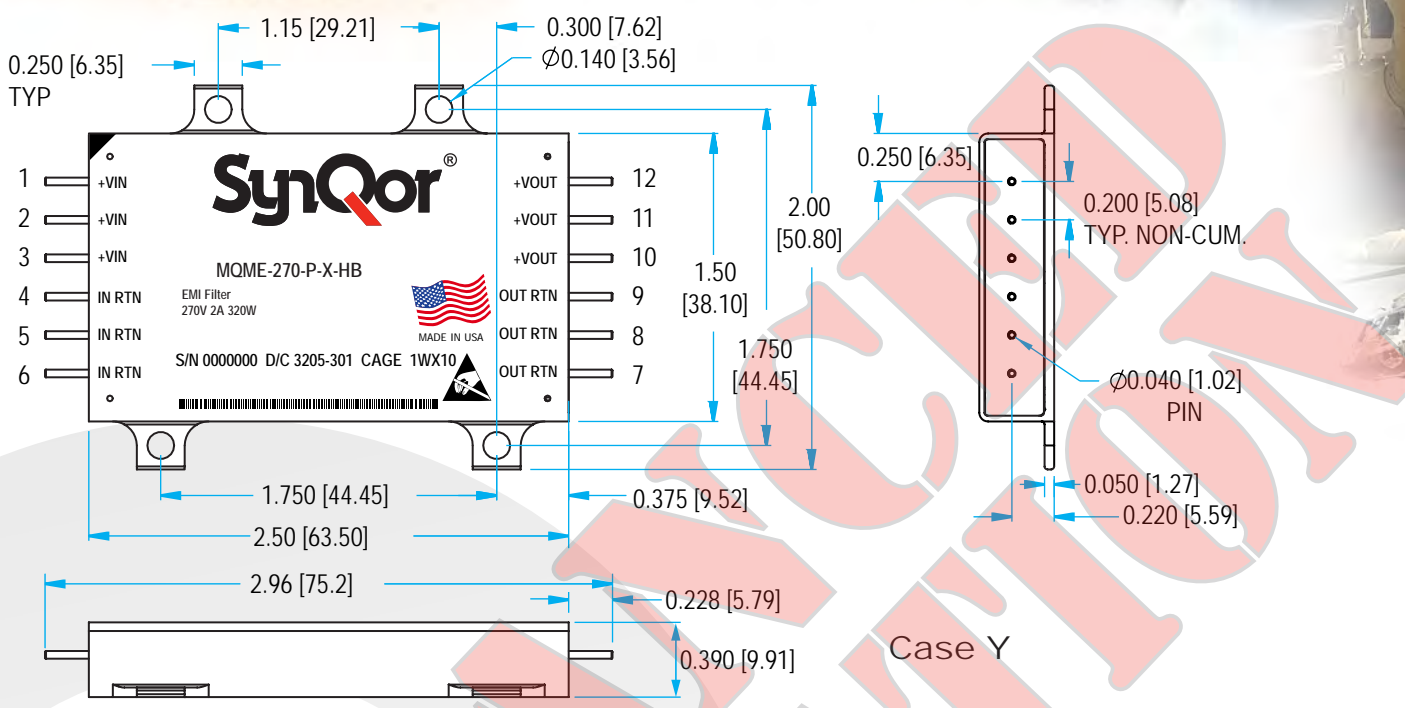

NOTES

- 1) Pins 0.040" (1.02mm) diameter
- 2) Pins Material: Copper
Finish: Gold over Nickel plate
- 3) All dimensions in inches (mm) Tolerances: x.xx +/-0.02 in. (x.x +/-0.5mm)
x.xxx +/-0.010 in. (x.xx +/-0.25mm)
- 4) Weight: 2.8 oz (78.5 g) typical
- 5) Workmanship: Meets or exceeds IPC-A-610C Class III
- 6) Print Labeling on Top Surface per Product Label Format Drawing

PIN DESIGNATIONS

Pin	Function	Pin	Function
1	Positive input	7	Output return
2	Positive input	8	Output return
3	Positive input	9	Output return
4	Input return	10	Positive output
5	Input return	11	Positive output
6	Input return	12	Positive output



Technical Specification

MQME-270-P
Current: 2A

MilQor FAMILY MATRIX

The table below shows the array of MilQor filters available. When ordering SynQor filters, please ensure that you use the complete part number according to the following Part Numbering System table. Contact the factory for other requirements.

Product Family Designator	Continuous Input Voltage	Power (Amperage) Rating	Version (see table below)	Features Available (In Addition to Passive Filter Components)				
				Enable Pass-Through Circuitry	Transient Suppression Circuitry	Soft-Start Circuitry	Reverse Polarity Protection Circuitry	Power Interrupt Hold-Up Capacitor Pre-Charger
MQME-28	40V	320W (20A)	P					
MQME-28E	70V	320W (20A)	T	•	•	•	•	
			HT	•	•	•	•	•
MQME-270	400V	320W (2A)	P					
MQME-270E	530V	320W (2A)	R				•	
			HR				•	•

PART NUMBERING SYSTEM

The part numbering system for SynQor's MilQor EMI filters follows the format shown in the table below.

Model Name	Input Voltage Range	Version	Package Outline/Pin Configuration	Screening Grade
MQME	28 28E	P T HT	U X Y	B C ES HB
	270 270E	P R HR	W Z	

Example: MQME-270-P-Y-HB

APPLICATION NOTES

A variety of application notes and technical white papers can be downloaded in pdf format from the SynQor website.

PATENTS

SynQor holds the following patents, one or more of which might apply to this product:

5,999,417	6,222,742	6,545,890	6,577,109
6,594,159	6,731,520	6,894,468	6,896,526
6,927,987	7,050,309	7,072,190	7,085,146
7,119,524	7,269,034	7,272,021	7,272,023

Contact SynQor for further information:

Phone: 978-849-0600
Toll Free: 888-567-9596
Fax: 978-849-0602
E-mail: power@synqor.com
Web: www.synqor.com
Address: 155 Swanson Road
 Boxborough, MA 01719
 USA

Warranty

SynQor offers a two (2) year limited warranty. Complete warranty information is listed on our website or is available upon request from SynQor.

Information furnished by SynQor is believed to be accurate and reliable. However, no responsibility is assumed by SynQor for its use, nor for any infringements of patents or other rights of third parties which may result from its use. No license is granted by implication or otherwise under any patent or patent rights of SynQor.