

SPECIFICATION

Part No.	:	GSA.8859.A.105111
Product Name	:	4dBi Adhesive Mini DSRC 5.9GHz Antenna 1M CFD200 with SMA(M) Connector
Feature	:	Omnidirectional For V2V and V2X Applications High Efficiency and High Peak Gain IP67 Rating Adhesive Mount on Plastic or Glass Low Loss 1M CFD200 Cable SMA(M) ST Connector Customizable Cable Type, Length, Connector Dims: 36*30*10mm RoHS compliant



1. Introduction

The GSA.8859 Mini DSRC antenna is an external adhesive mount antenna that operates from 5850-5925MHz for DSRC systems.

DSRC (Dedicated Short Range Communications) is the communications medium of choice for active safety V2V (Vehicle-to-Vehicle) and V2X (Vehicle-to-Other) systems, primarily allocated for vehicle safety applications. DSRC supports high speed, low latency, short-range V2V/V2X wireless communications. The GSA.8859 at only 10mm comes in a very compact size enabling flexibility of integration. It can be mounted on glass or plastic surfaces easily with the double-sided adhesive. The antenna features high peak gain at 4.14 dBi on glass and 3.24 dBi on 2mm thick plastic.

Contact your regional Taoglas office for support to integrate and test this antenna's performance in your device.

2. Specification

Wi-Fi		
Frequency	5850~5925MHz	
Efficiency (%)		
In free space	0.3m	80.23
	1m	68.30
	2m	54.24
	3m	44.09
	5m	28.26
On glass	0.3m	72.05
	1m	61.33
	2m	48.71
	3m	39.59
	5m	25.38
On the 2mm ABS	0.3m	78.34
	1m	66.67
	2m	52.96
	3m	43.05
	5m	27.60
Average Gain (dBi)		
In free space	0.3m	-0.96
	1m	-1.66
	2m	-2.66
	3m	-3.56
	5m	-5.49
On glass	0.3m	-1.42
	1m	-2.12
	2m	-3.12
	3m	-4.02
	5m	-5.96
On the 2mm ABS	0.3m	-1.06
	1m	-1.76
	2m	-2.76
	3m	-3.66
	5m	-5.59

Peak Gain (dBi)		
In free space	0.3m	3.27
	1m	2.57
	2m	1.57
	3m	0.67
	5m	-1.30
On glass	0.3m	4.84
	1m	4.14
	2m	3.14
	3m	2.24
	5m	0.34
On the 2mm ABS	0.3m	3.94
	1m	3.24
	2m	2.24
	3m	1.34
	5m	-0.66
Return loss	<-10	
VSWR	<2	
Impedance	50	
Polarization	Linear	
Radiation Pattern	Omnidirectional	
Input Power	5W	
MECHANICAL		
Dimensions	36*30*10mm	
Casing	PP	
Connector	SMA(M) ST, fully customizable	
Cable	1M CFD200, fully customizable	
Waterproof	IP67	
Weight	42g	
ENVIRONMENTAL		
Temperature Range	-40°C to 85°C	
Humidity	Non-condensino 65°C 95% RH	

3. Antenna Characteristics

3.1 Antenna Test Setup

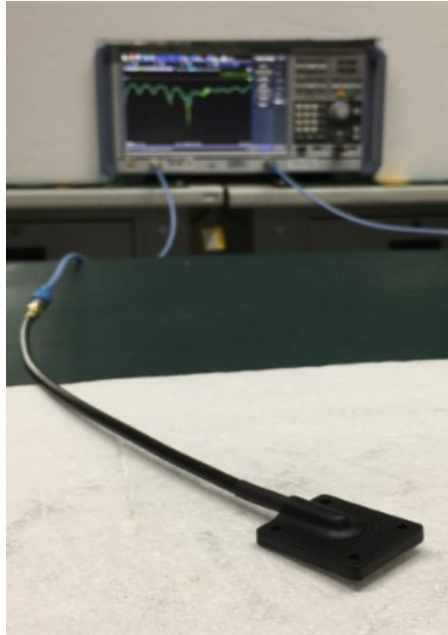

Free Space

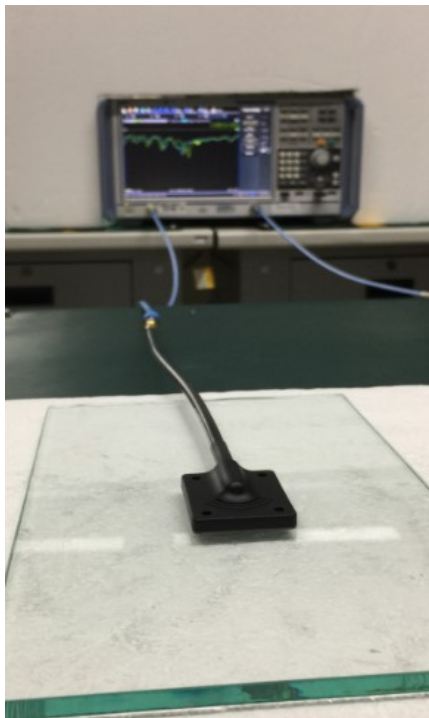

On Glass

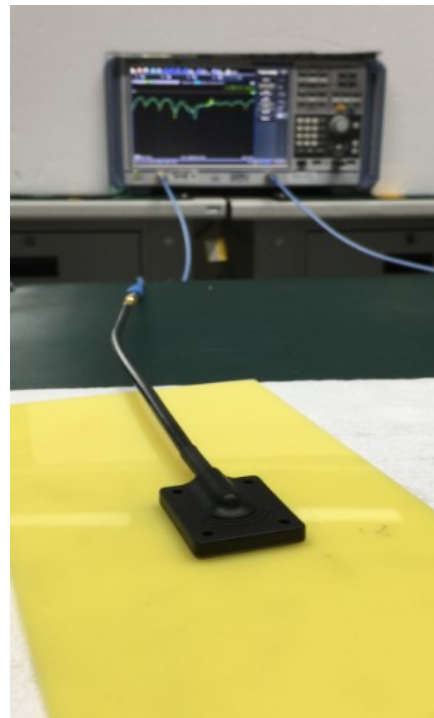

On 2mm ABS

3.2 Return Loss

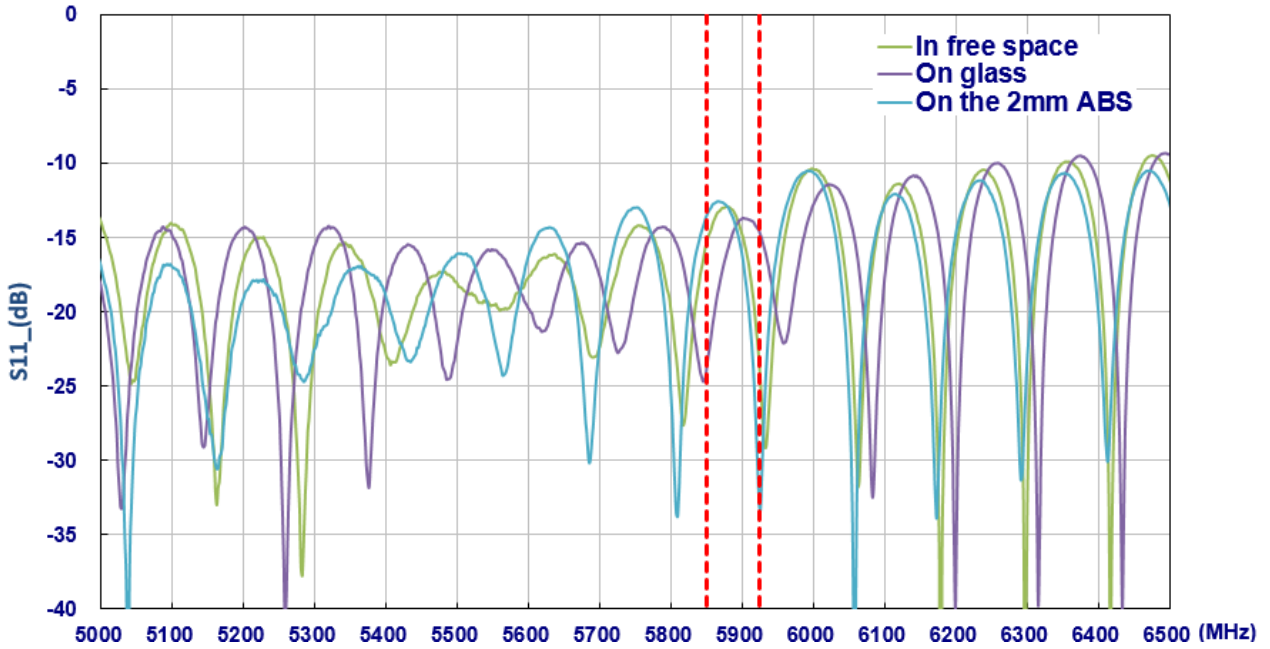

3.3 Efficiency

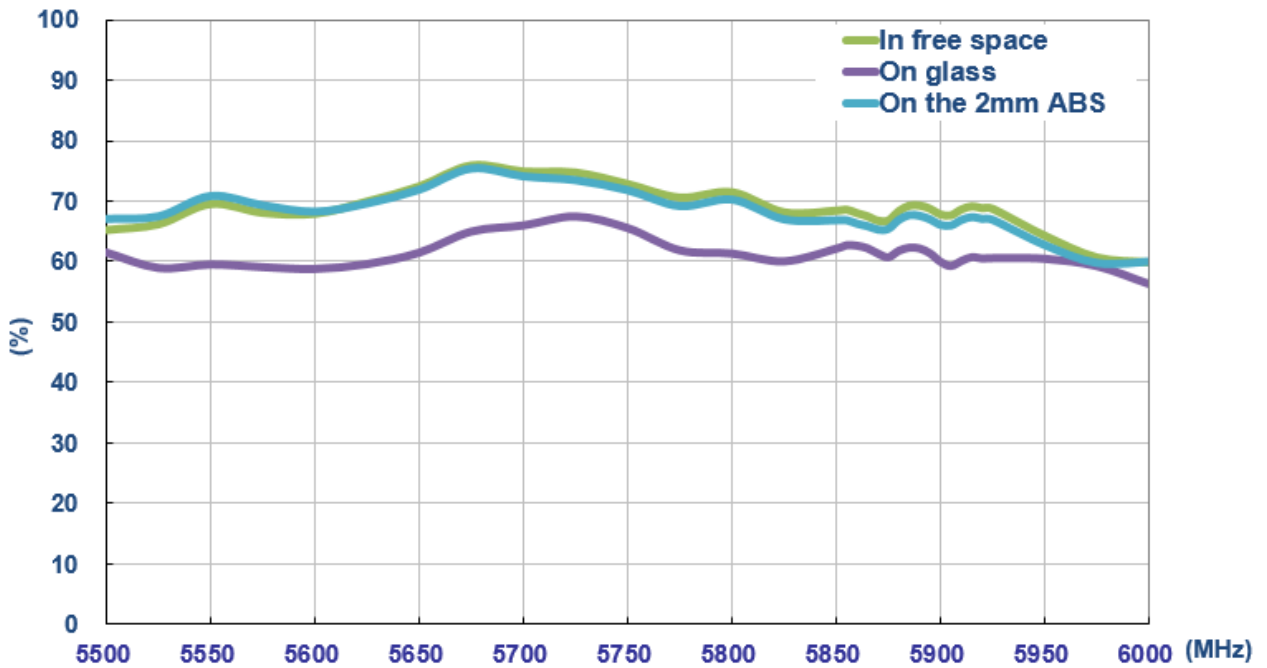

3.4 Peak Gain

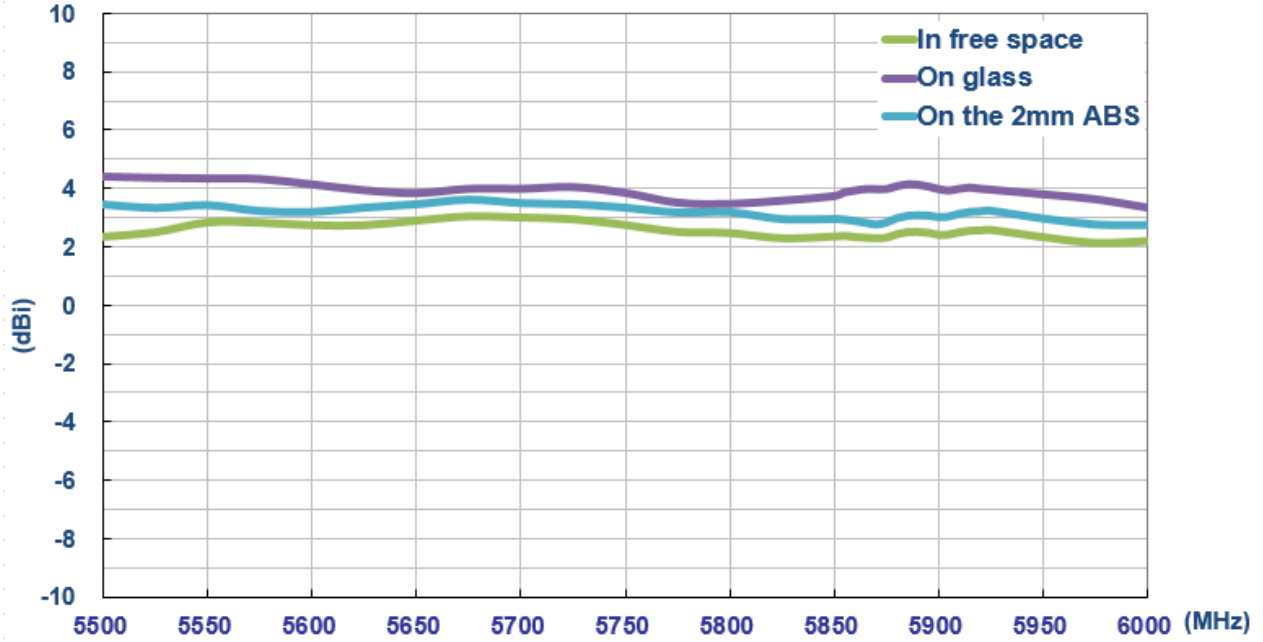

3.5 Average Gain

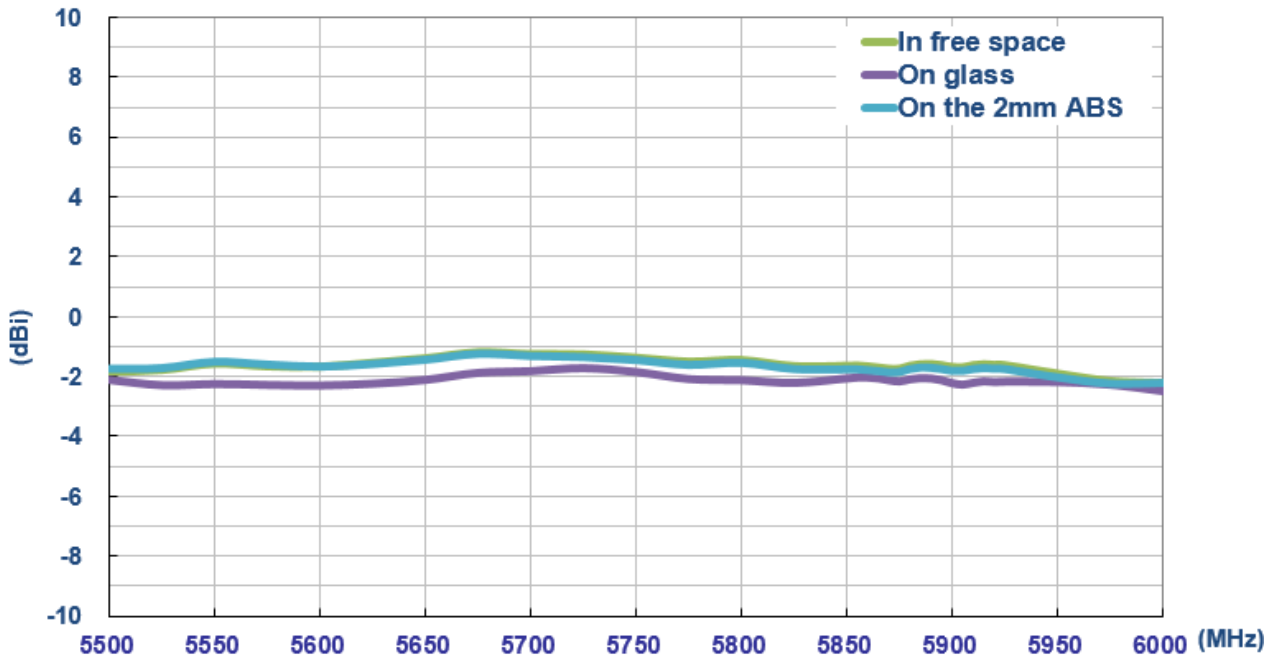

4. Antenna Radiation Patterns

4.1 Antenna setup (Free space with 1m cable)

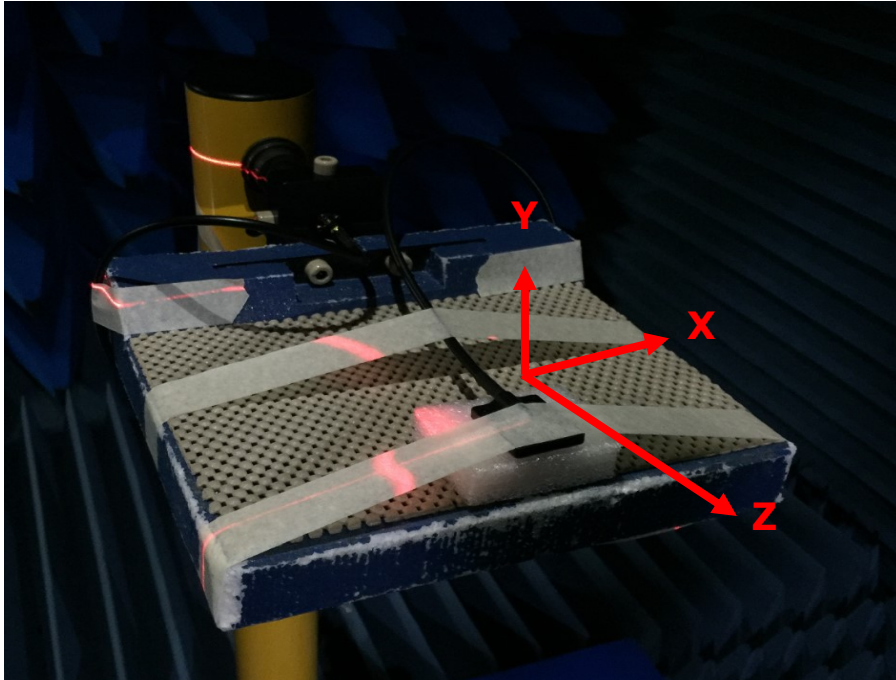

Free Space

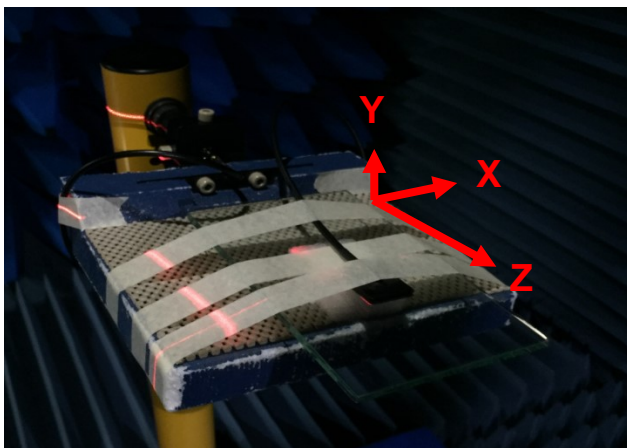

On Glass

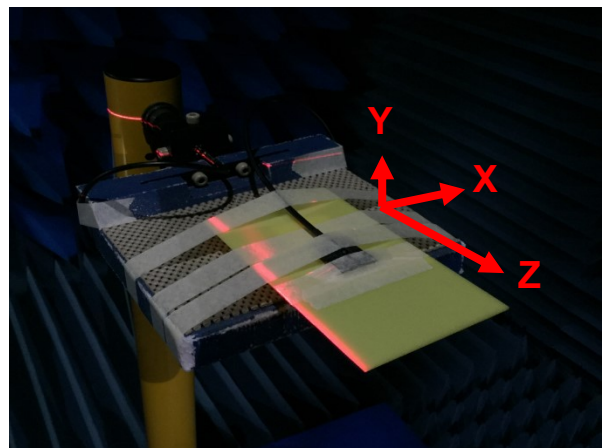

On 2mm ABS

Antenna testing Setup in ETS Anechoic Chamber

4.2 2D Radiation Patterns

4.2.1 In Free Space

XY Plane

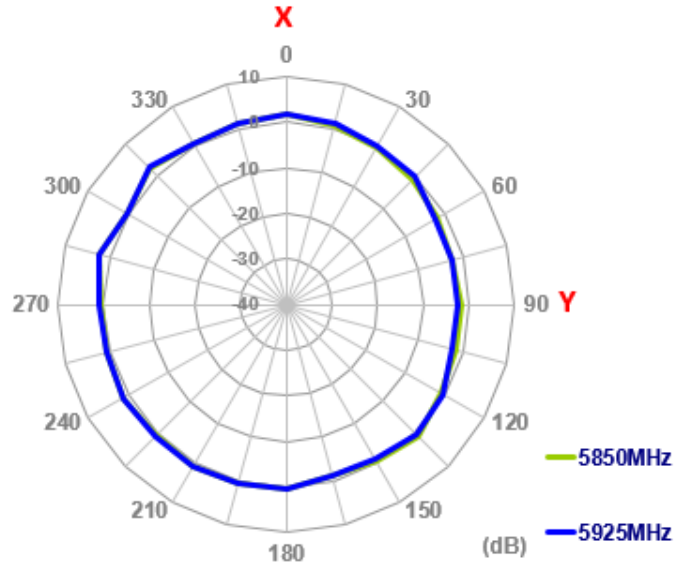

XZ Plane

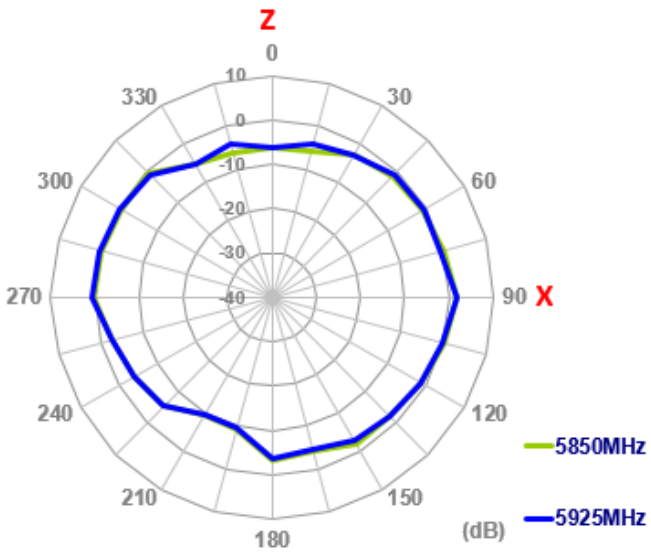

YZ Plane

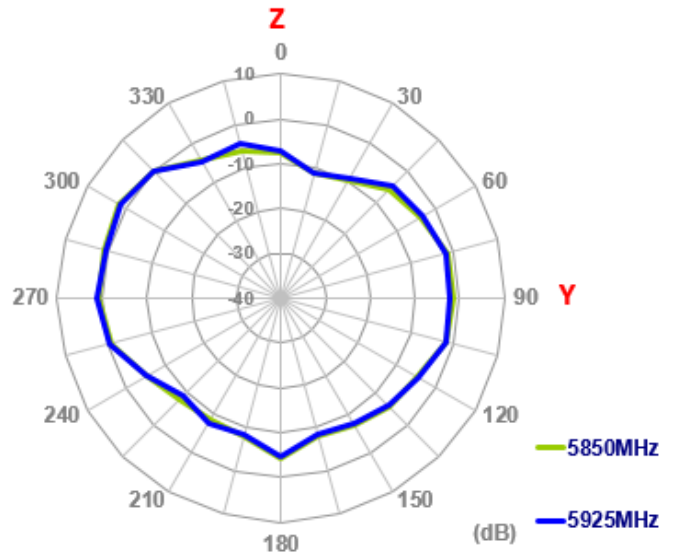

4.2.2 On Glass

XY Plane

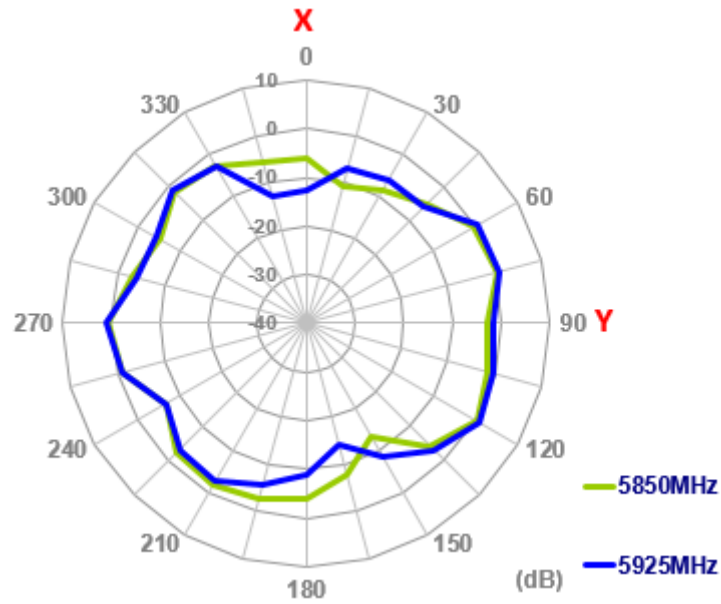

XZ Plane

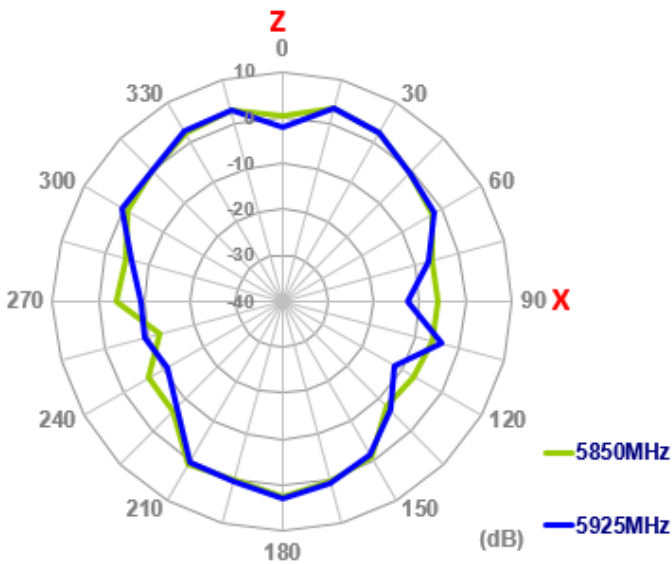

YZ Plane

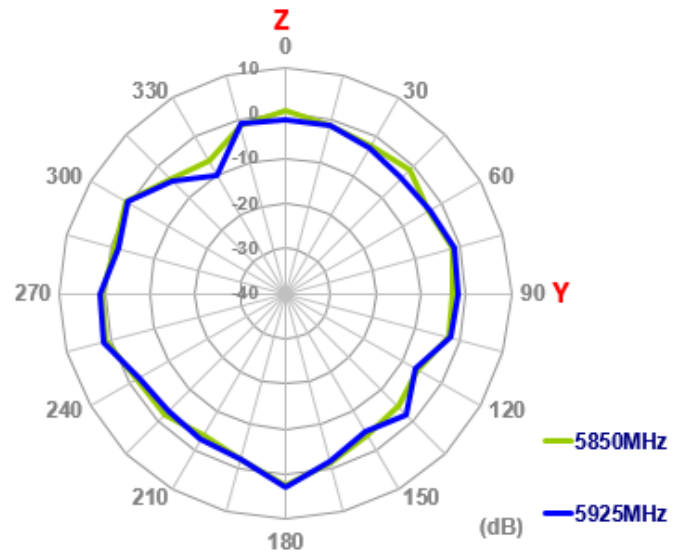

4.2.3 On 2mm ABS

XY Plane

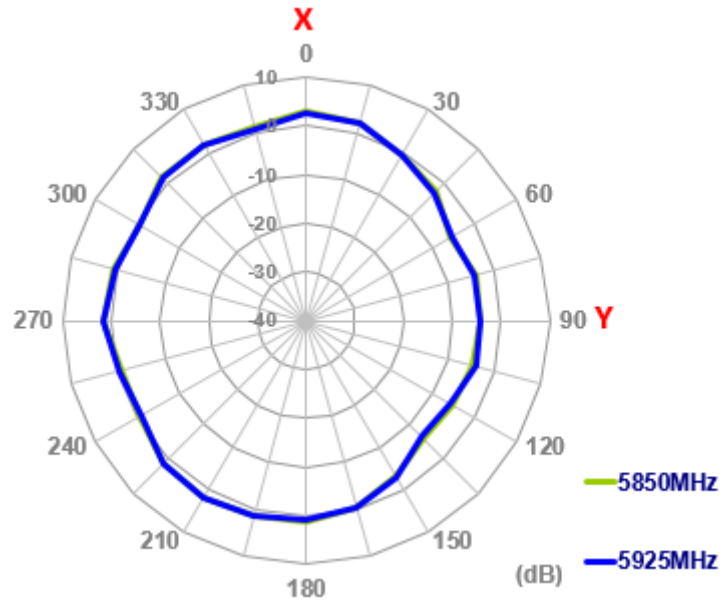

XZ Plane

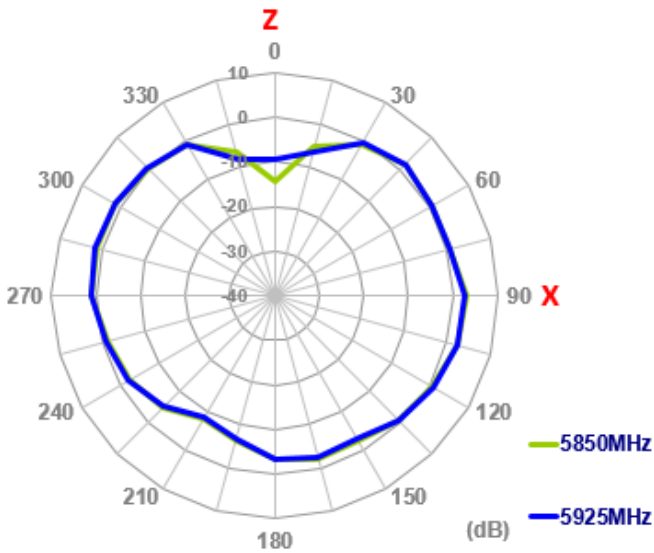

YZ Plane

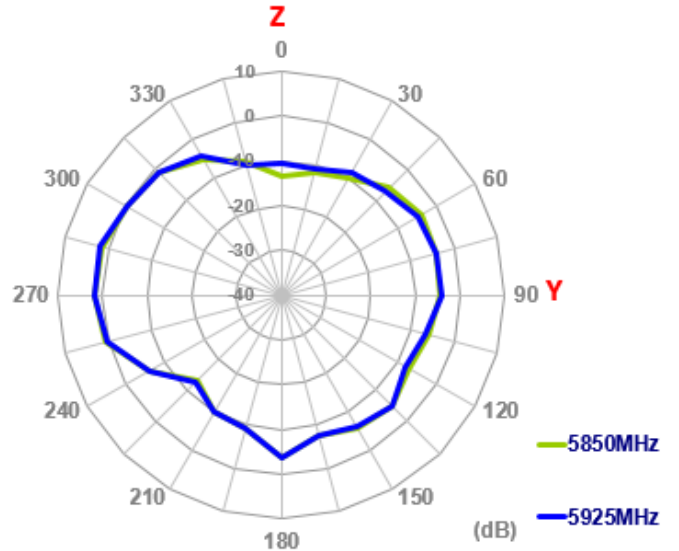

4.3 Antenna 3D Radiation Pattern

4.3.1 In Free Space

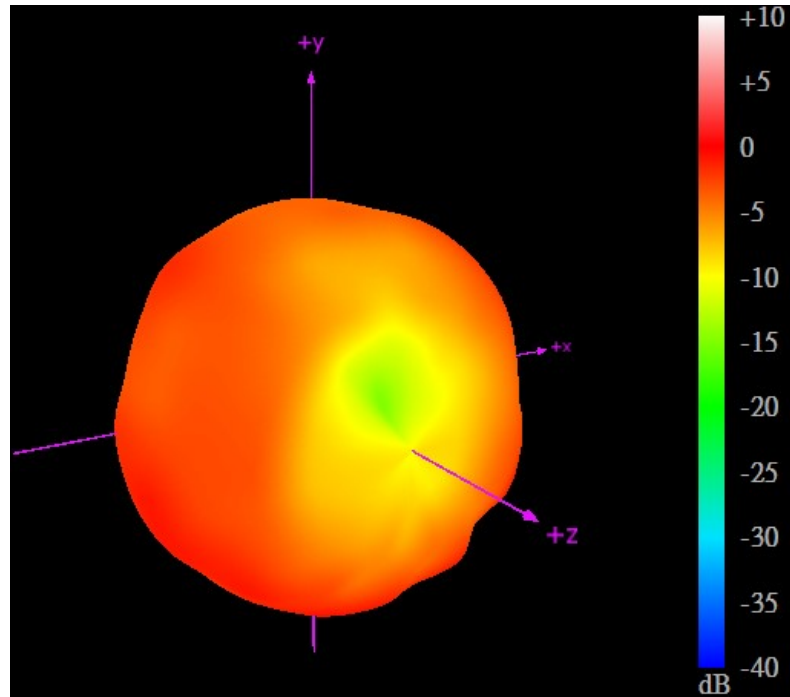

5850MHz

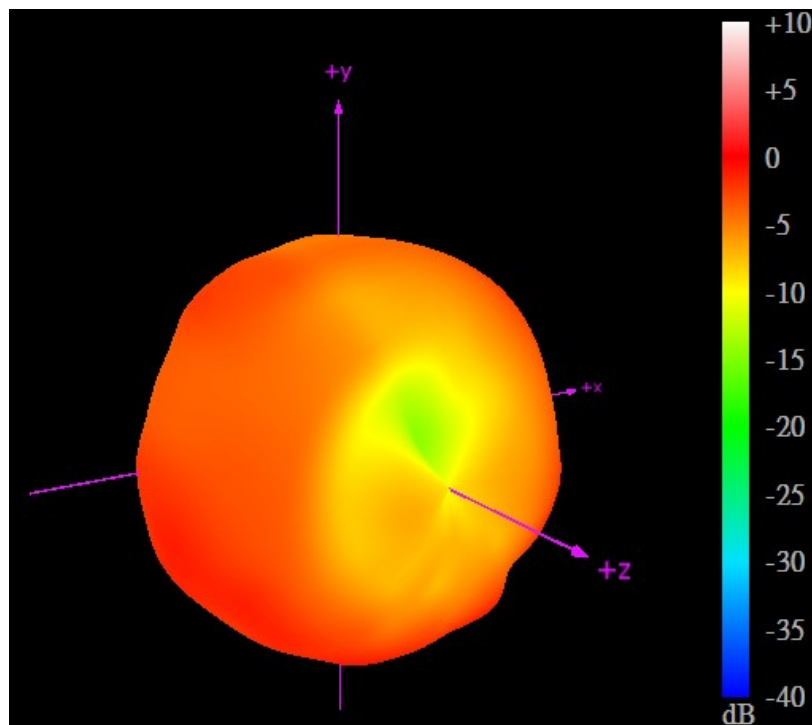

5925MHz

4.3.2 On Glass

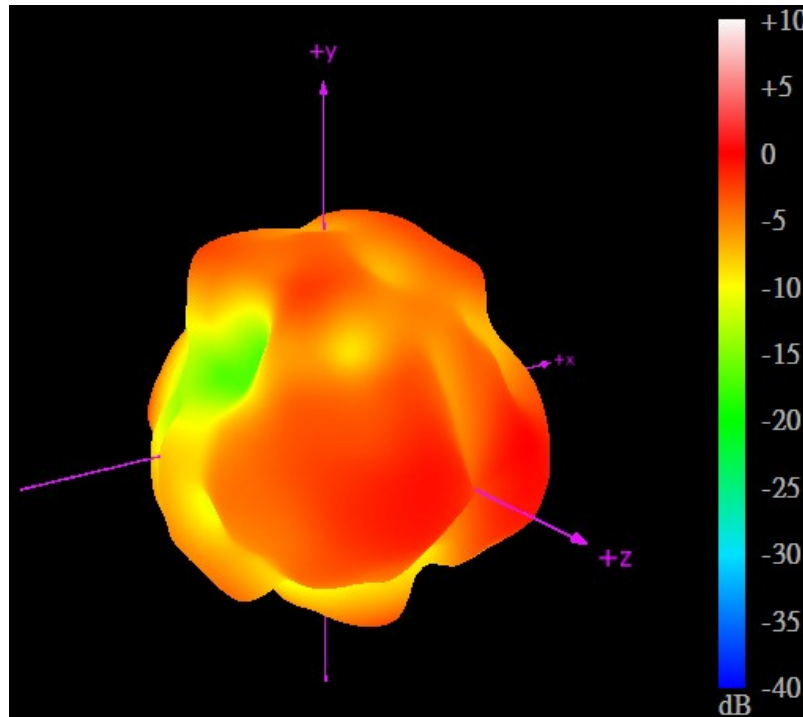

5850MHz

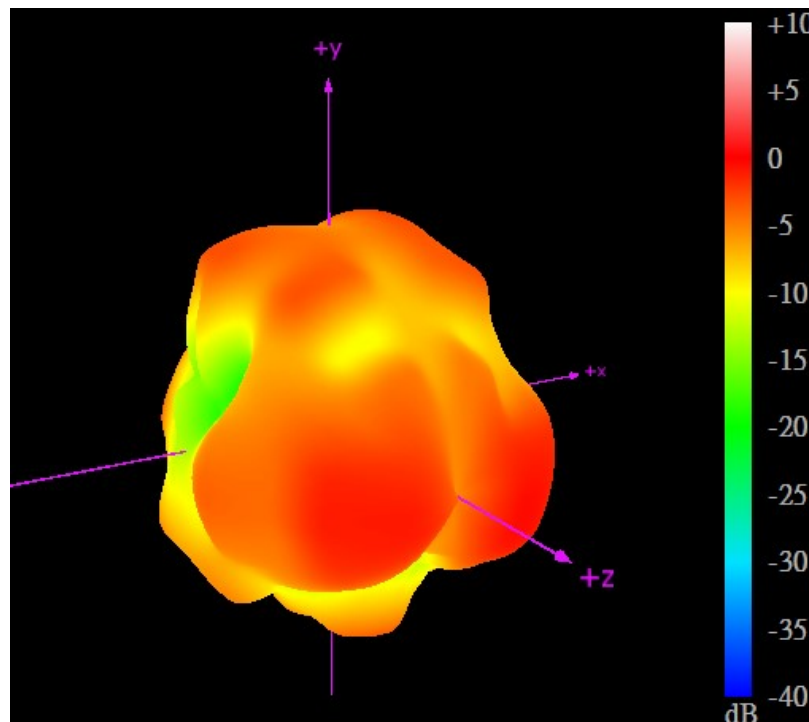

5925MHz

4.3.3 On 2mm ABS

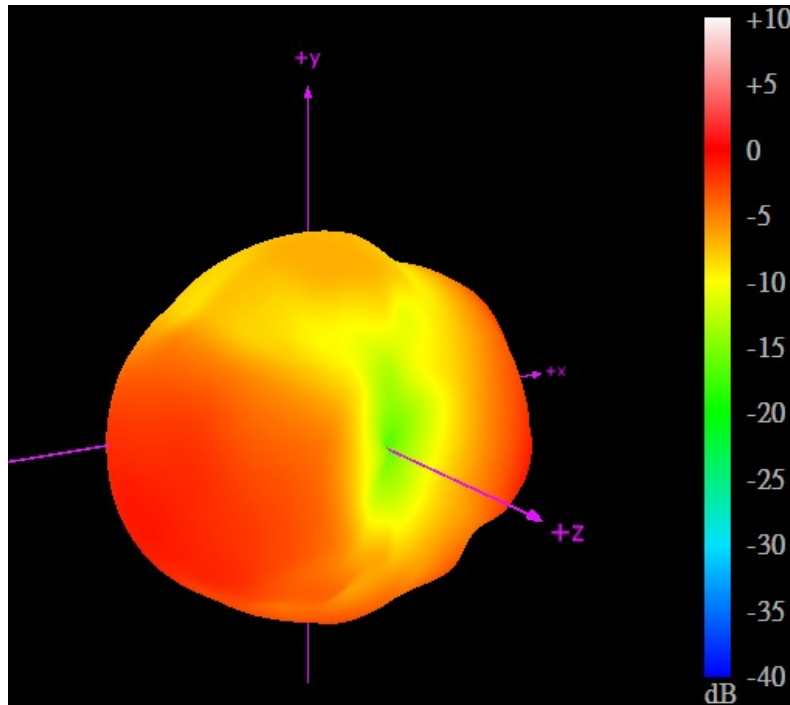

5850MHz

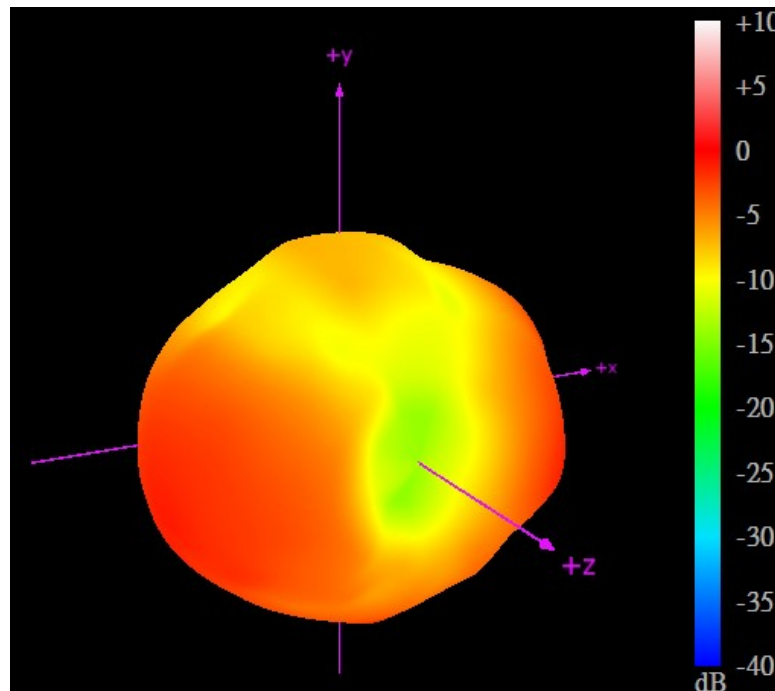

5925MHz

5. Drawing (Unit: mm)

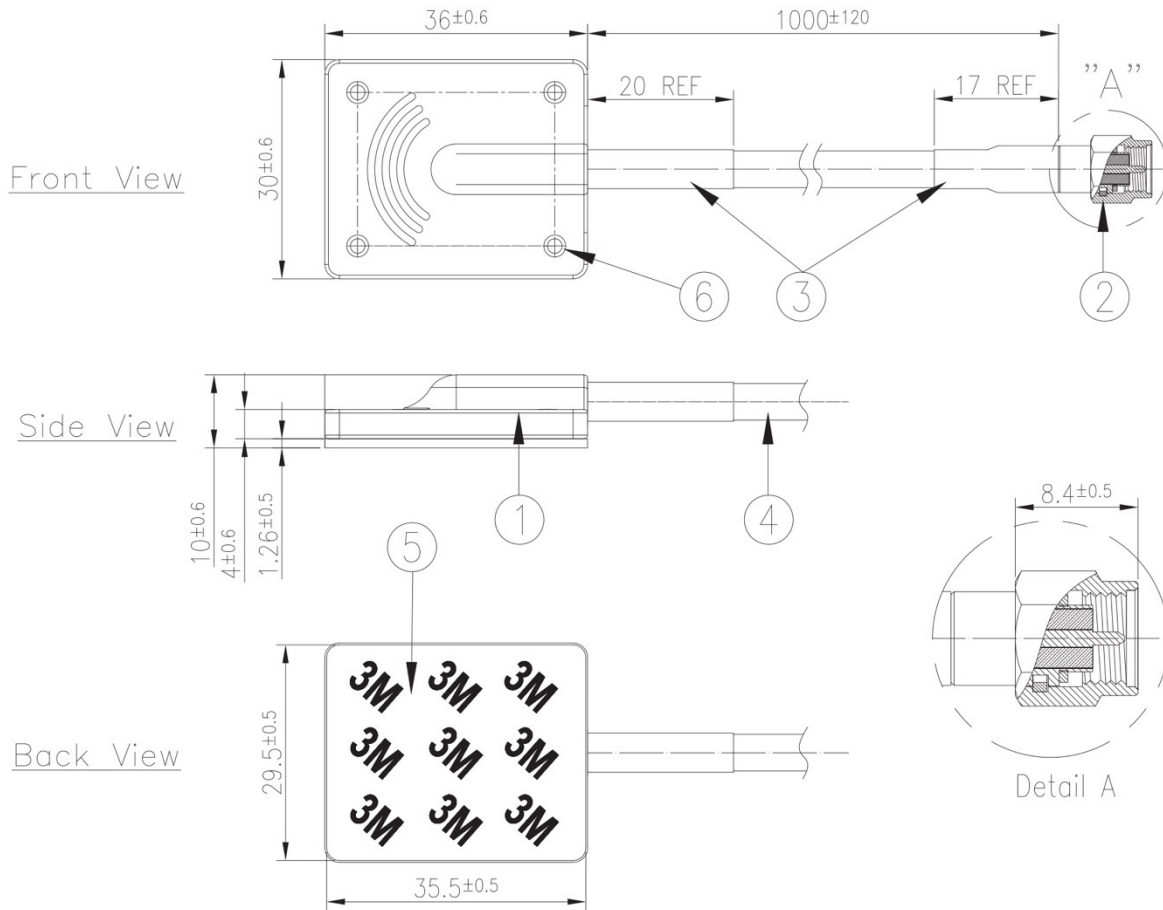

	Name	Material	Finish	QTY
1	GSA.8859 Housing	PP	Black	1
2	SMA(M)ST	Brass	Au Plated	1
3	Heat Shrink Tube	PE	Black	2
4	CFD200 Coaxial Cable	PE	Black	1
5	Double-Side Adhesive With Gray Foam	VHB 4941 1.26t	White Liner	1
6	GSA.8859 PCB	FR4 1.0t	Black	1

6. Packaging

1pc GSA.8859.A.105111 per Small PE Bag
 Bag Dimensions - 160*300 mm
 Weight - 50g

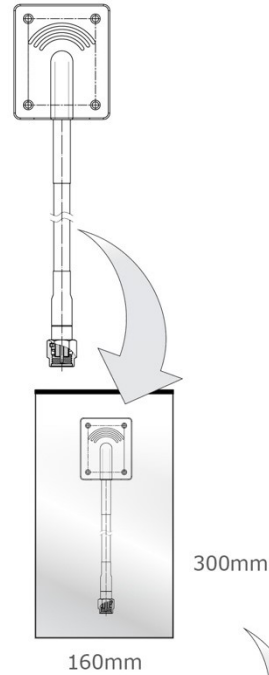

50pcs GSA.8859.A.105111 per Carton
 Carton Dimensions - 320*250*290mm
 Weight - 2.6Kg

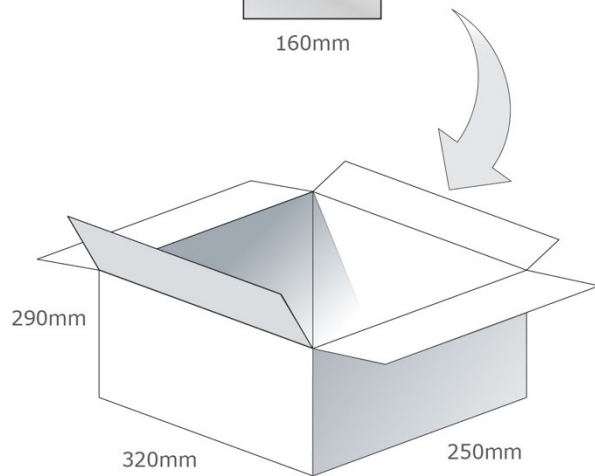

Pallet Dimensions:
 1100mm*1000mm*1360mm
 48 Cartons per Pallet
 12 Cartons per Layer, 4 Layers

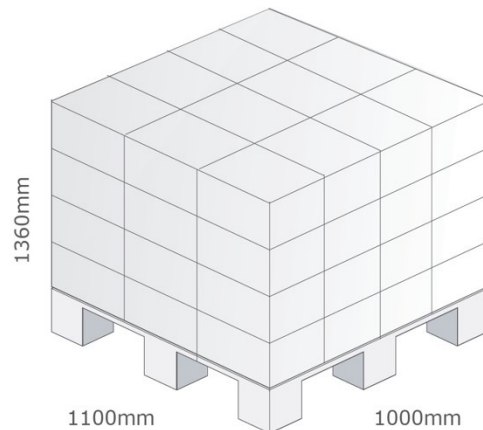

7. Application Note

The WSA.2458 antenna performance with different cable lengths is shown below.

7.1 In free Space

7.1.1 Return Loss

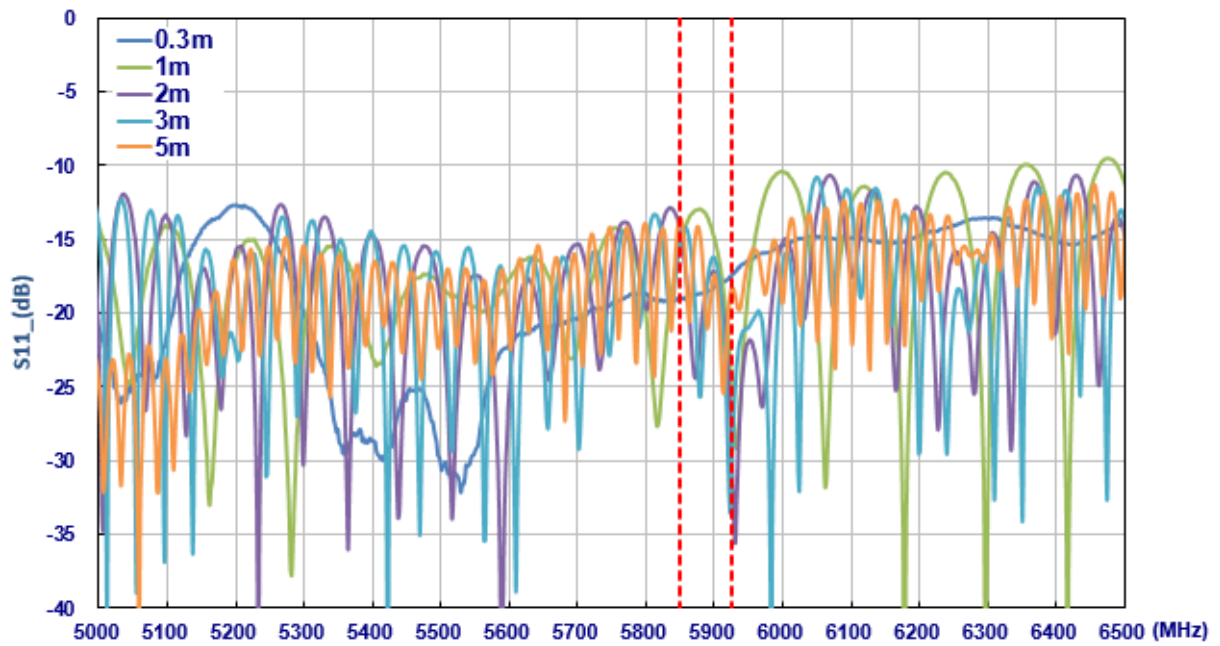

7.1.2 Efficiency

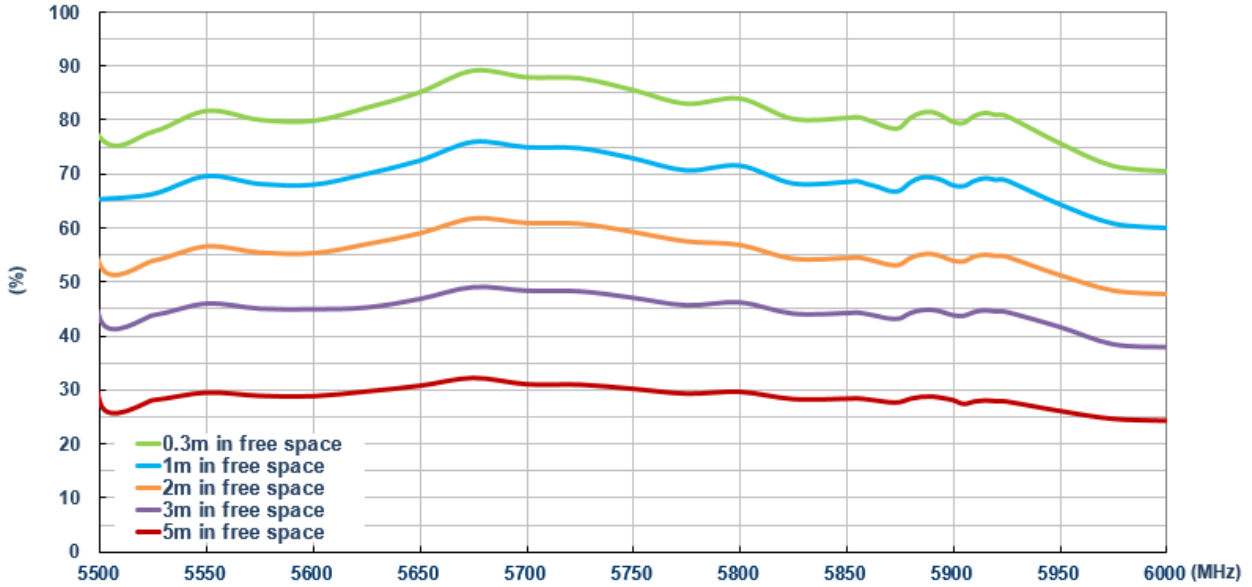

7.1.3 Peak Gain

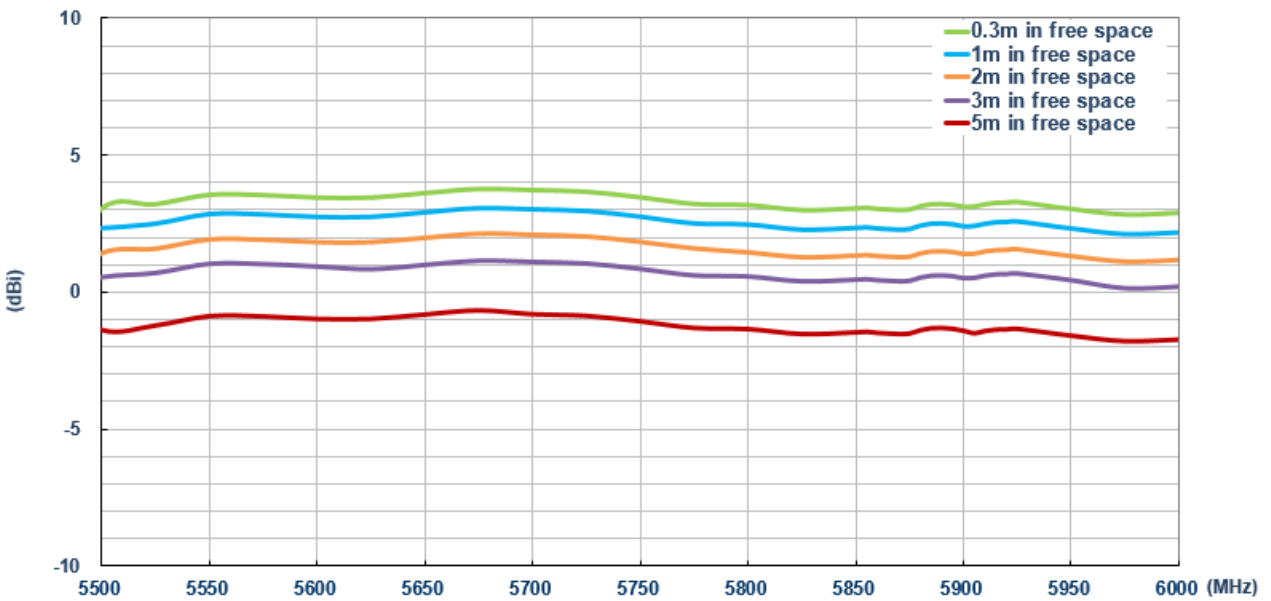

7.1.4 Average Gain

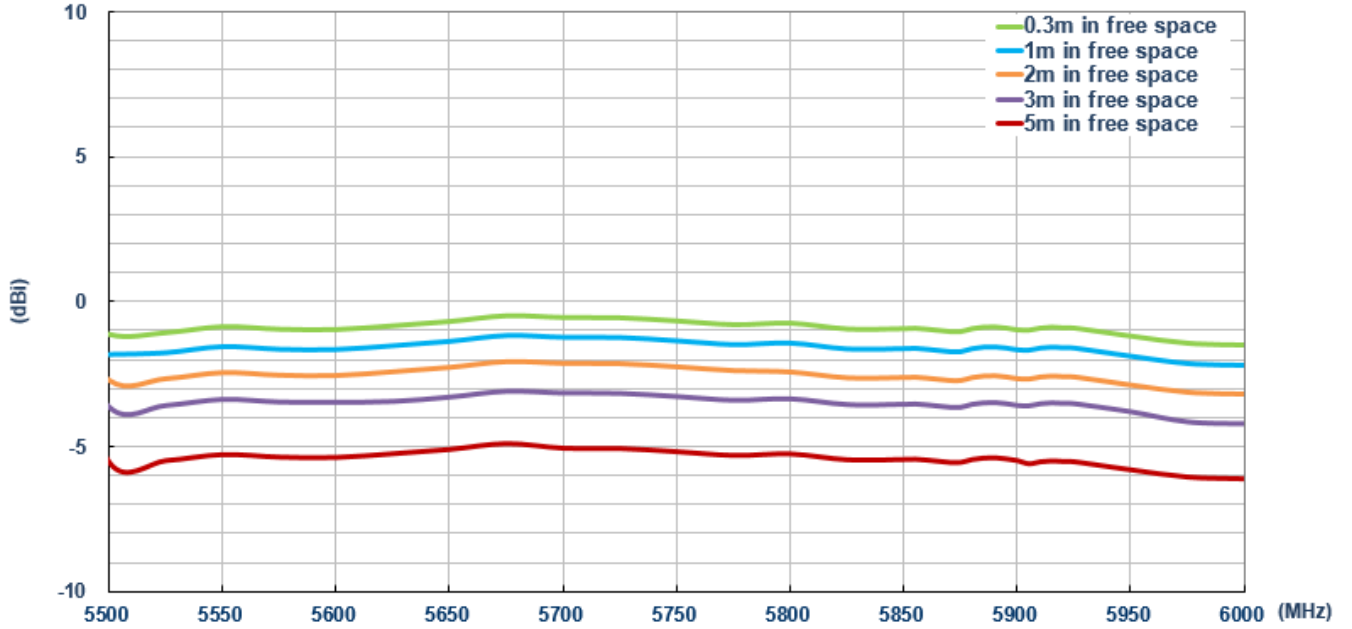

7.2 On Glass

7.2.1 Return Loss

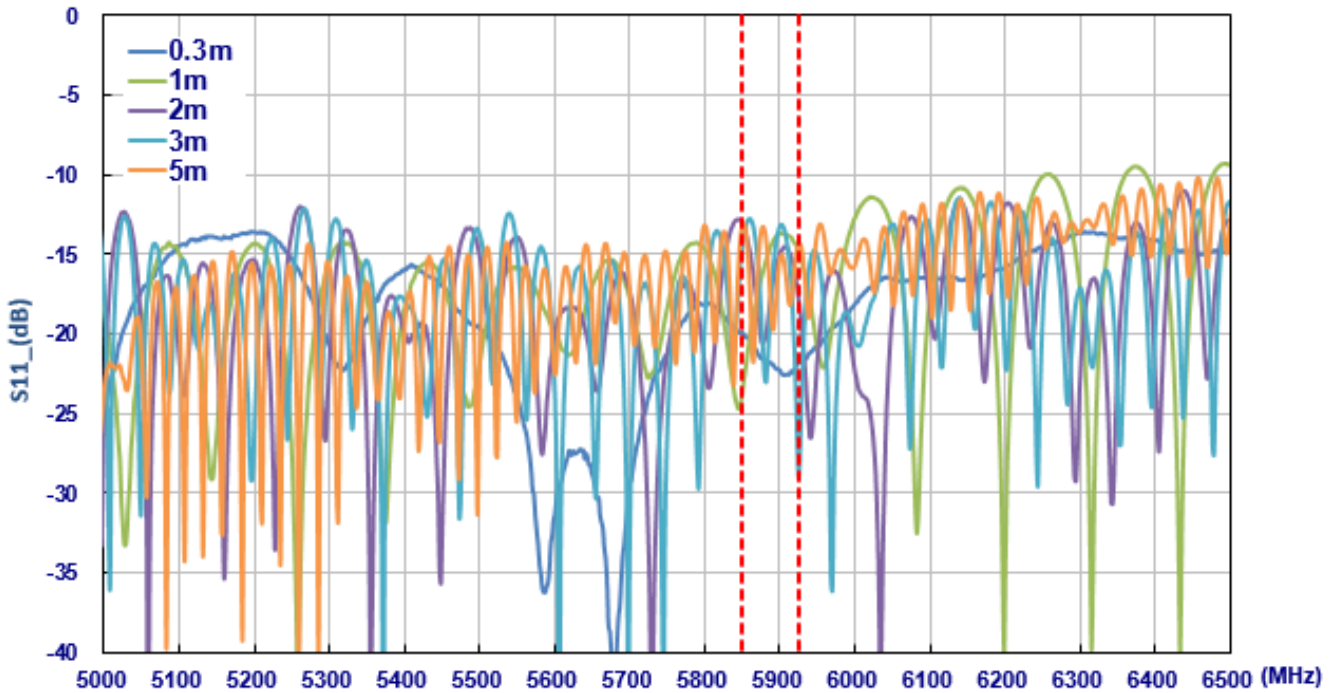

7.2.2 Efficiency

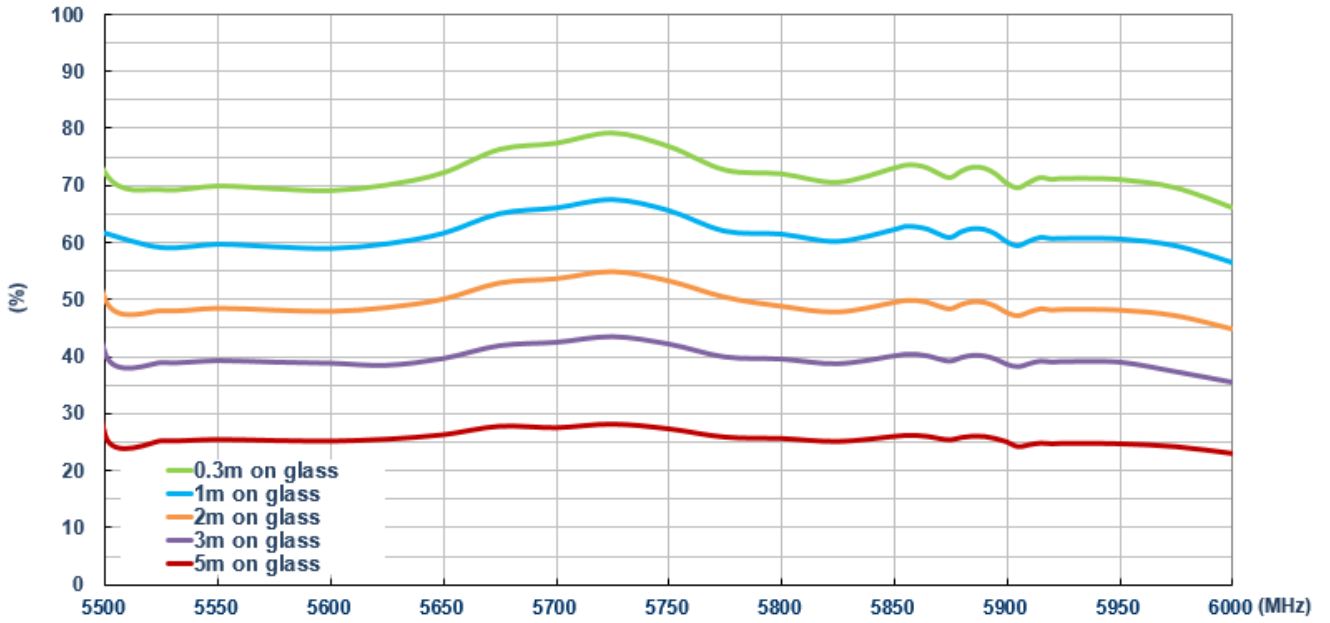

7.2.3 Peak Gain

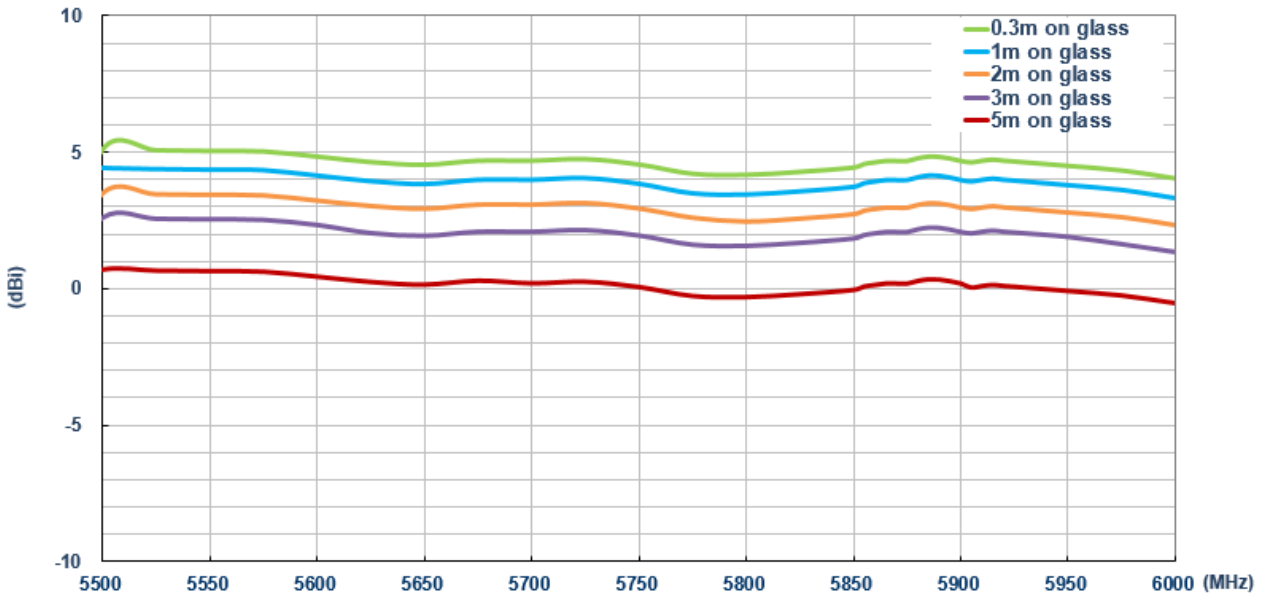

7.2.4 Average Gain

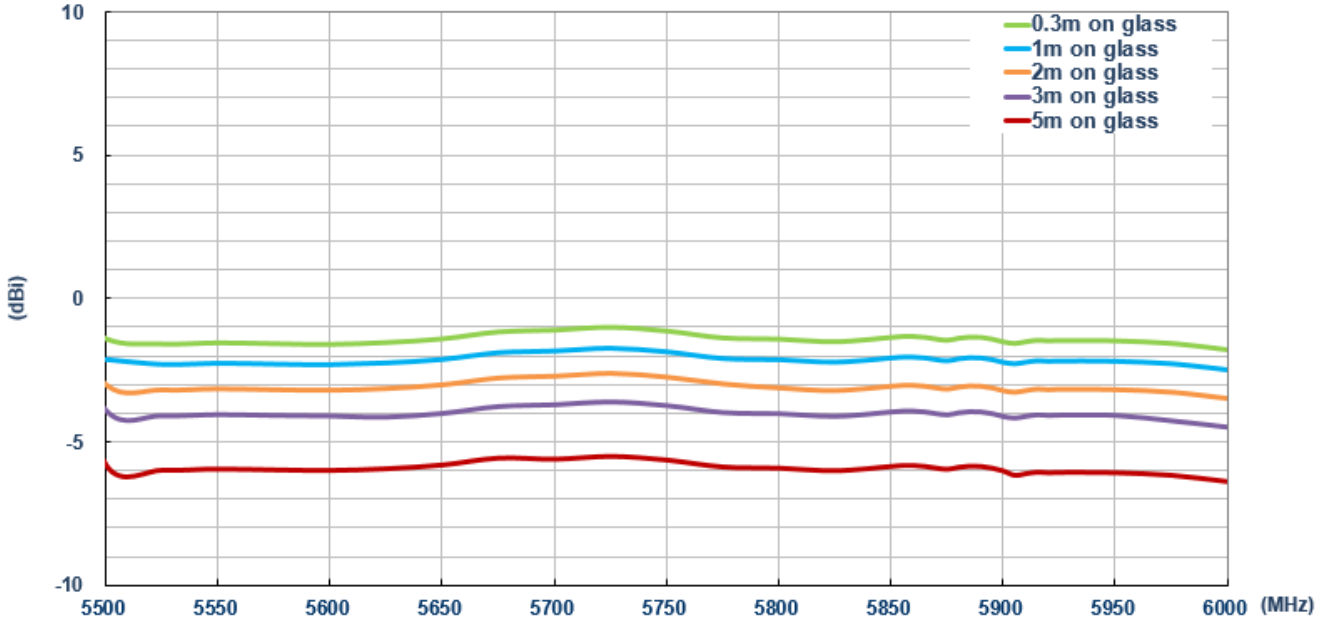

7.3 On 2mm ABS

7.3.1 Return Loss

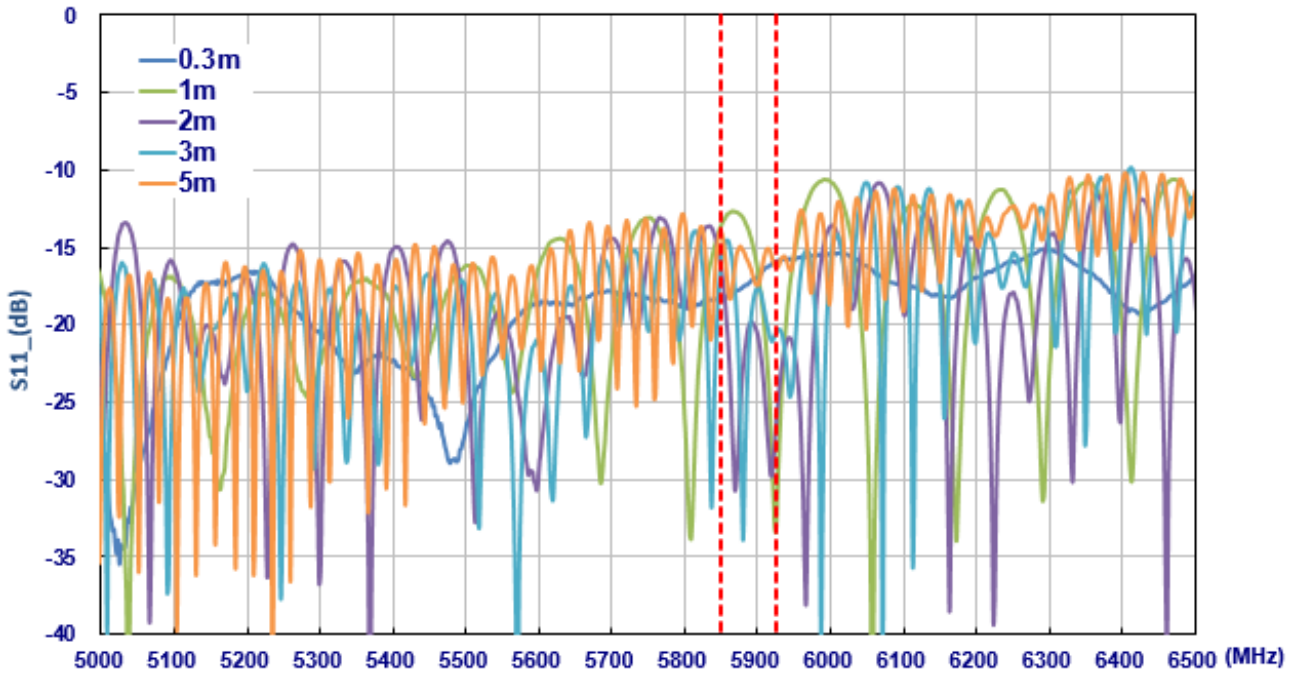

7.3.2 Efficiency

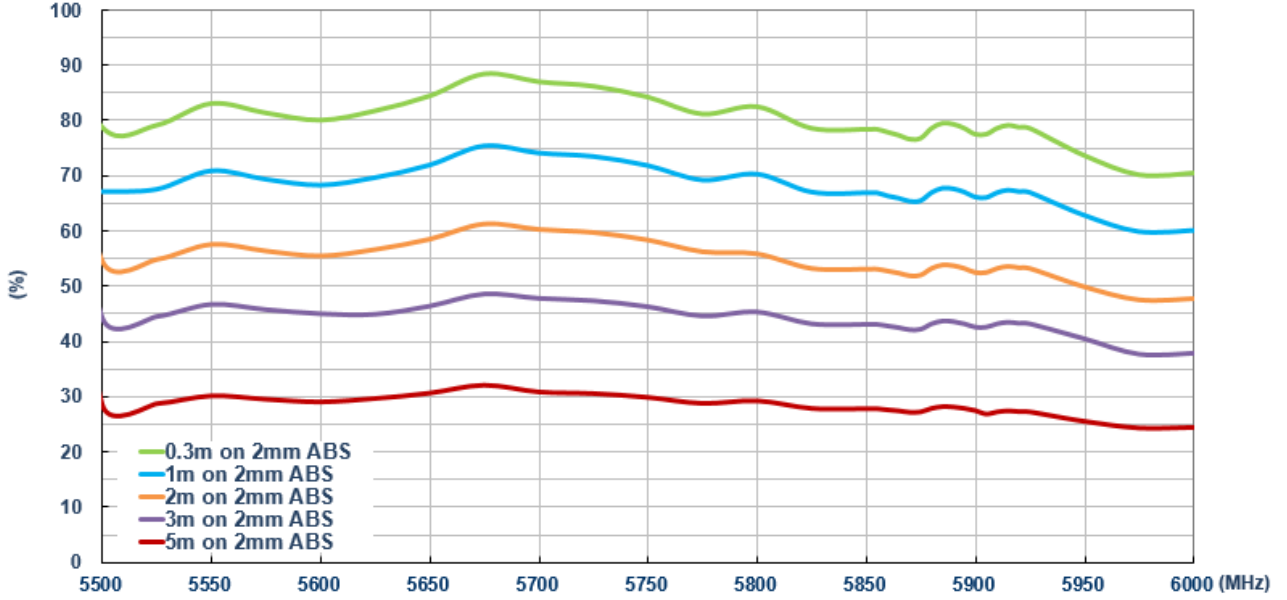

7.3.3 Peak Gain

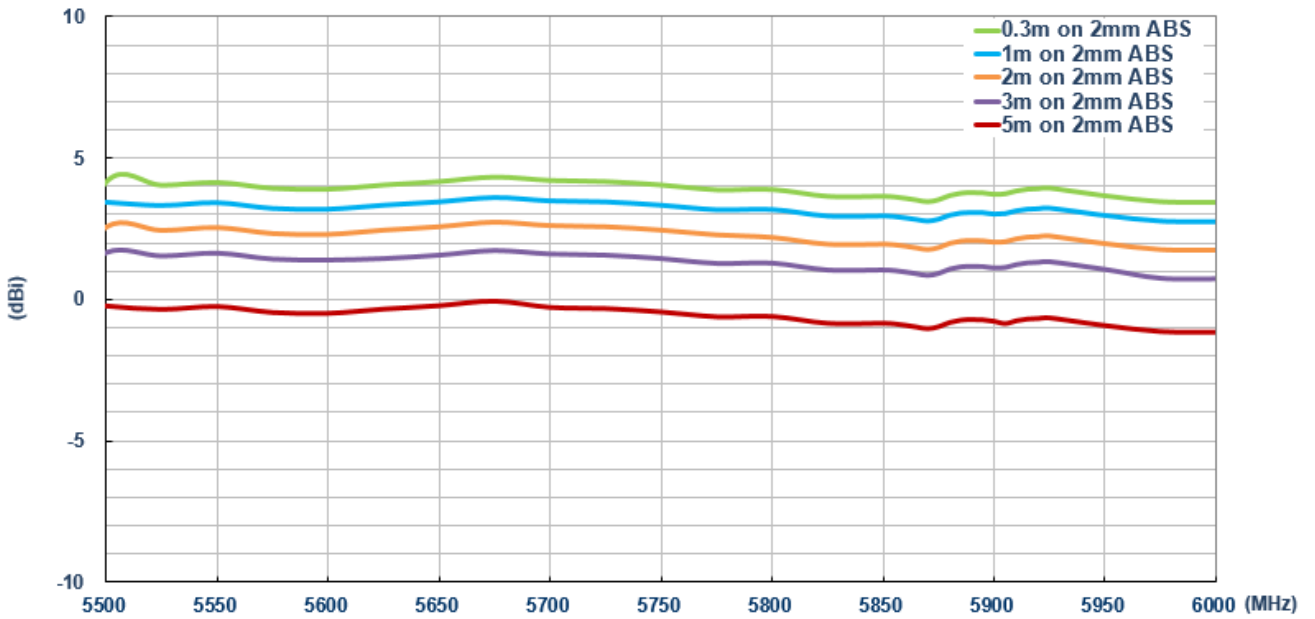

7.3.4 Average Gain

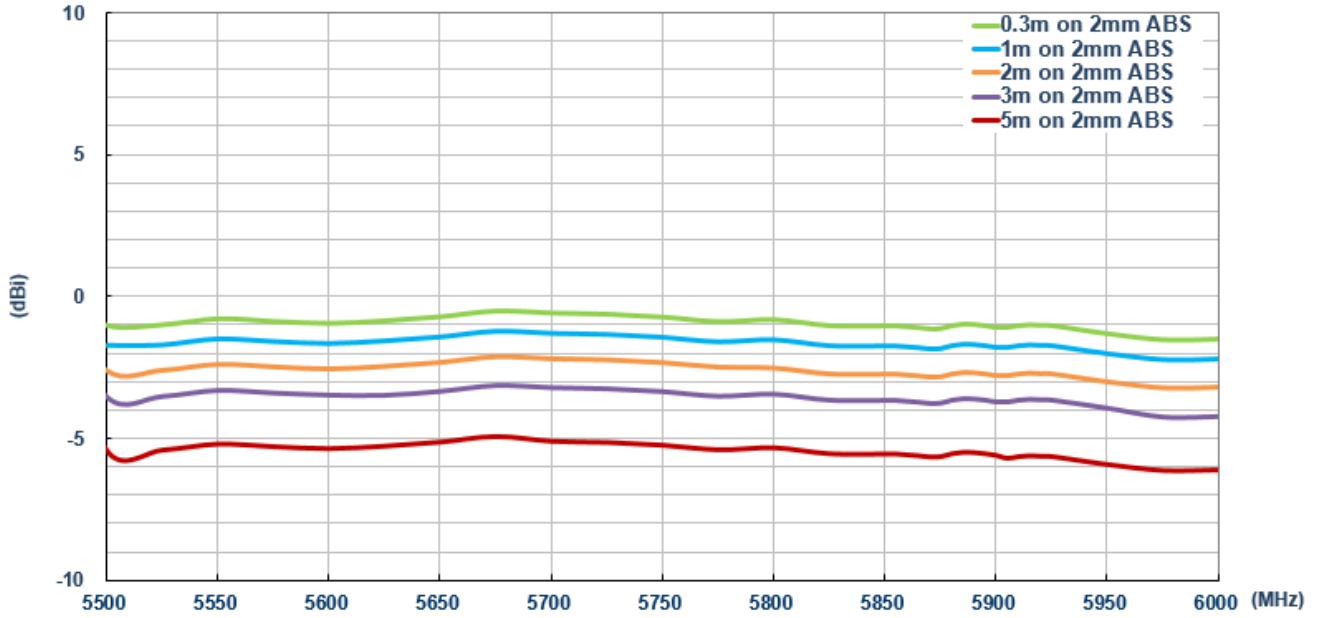

Taoglas makes no warranties based on the accuracy or completeness of the contents of this document and reserves the right to make changes to specifications and product descriptions at any time without notice.

Taoglas reserves the rights to this document and the information contained herein. Reproduction, use or disclosure to third parties without express permission is strictly prohibited.

Copyright © Taoglas Ltd.