

# HF2160

# MINIATURE HIGH POWER RELAY



File No.:E134517



File No.: R50153835



File No.:CQC08002027546



## Features

- 30A switching capability
- PCB coil terminals, ideal for heavy duty load
- 2.5kV dielectric strength (between coil and contacts)
- Plastic sealed and Dust protected types available
- UL insulation system: Class F available
- Environmental friendly product (RoHS compliant)
- Outline Dimensions: (32 x 27.5 x 19.8) mm

## CONTACT DATA

Contact arrangement	1A	1B	1C (NO)	1C (NC)
Contact resistance	50mΩ max.(at 1A 24VDC)			
Contact material	AgSnO <sub>2</sub> , AgCdO			
Contact rating (Res. load)	30A 240VAC 20A 30VDC	15A 240VAC 10A 30VDC	20A 240VAC 20A 30VDC	10A 240VAC 10A 30VDC
Max. switching power	7200VA 600W	3600VA 300W	4800VA 600W	2400VA 300W
Max. switching voltage	277VAC / 30VDC			
Max. switching current	40A	15A	20A	10A
Mechanical endurance	1 x 10 <sup>7</sup> OPS			
Electrical endurance	1A type: 1 x 10 <sup>5</sup> OPS (30A 240VAC, Resistive load, AgCdO, Room temp., 1s on 9s off)			

## COIL

Coil power	Approx. 900mW
------------	---------------

## COIL DATA

at 23°C

Nominal Voltage VDC	Pick-up Voltage VDC max.	Drop-out Voltage VDC min.	Max. Voltage VDC*	Coil Resistance Ω
5	3.75	0.5	6.5	27 x (1±10%)
6	4.50	0.6	7.8	40 x (1±10%)
9	6.75	0.9	11.7	97 x (1±10%)
12	9.00	1.2	15.6	155 x (1±10%)
15	11.25	1.5	19.5	256 x (1±10%)
18	13.50	1.8	23.4	380 x (1±10%)
24	18.00	2.4	31.2	660 x (1±10%)
48	36.00	4.8	62.4	2560 x (1±10%)
70	52.50	7.0	91.0	5500 x (1±10%)
110	82.50	11.0	143.0	13450 x (1±10%)

Notes: \*Maximum voltage refers to the maximum voltage which relay coil could endure in a short period of time.

## CHARACTERISTICS

Insulation resistance	1000MΩ (at 500VDC)	
Dielectric strength	Between coil & contacts	2500VAC 1min
	Between open contacts	1500VAC 1min
Operate time (at nomi. volt.)	15ms max.	
Release time (at nomi. volt.)	10ms max.	
Ambient temperature	-55°C to 85°C	
Shock resistance	Functional	98m/s <sup>2</sup>
	Destructive	980m/s <sup>2</sup>
Vibration resistance	10Hz to 55Hz 1.5mm DA	
Humidity	5% to 85% RH	
Termination	PCB & QC	
Unit weight	Approx. 30g	
Construction	Plastic sealed, Dust protected	

- Notes: 1) For plastic sealed type, the venting-hole should be excised in test.  
 2) The data shown above are initial values.  
 3) Please find coil temperature curve in the characteristic curves below.  
 4) UL insulation system: Class F, Class B.



HONGFA RELAY

ISO9001, ISO/TS16949, ISO14001, OHSAS18001, IECQ QC 080000 CERTIFIED

2014 Rev. 1.01

## SAFETY APPROVAL RATINGS

### UL/CUL

Contact material	Load type	Volts	1 Form A	1 Form B	1 Form C (NO)	1 Form C (NC)	
AgCdO	General purpose	125/240VAC	30A	15A	30A	15A	
		277VAC	30A	30A	30A	30A	
	Resistive	125/240VAC	30A	15A	--	--	
		30VDC	20A	10A	20A	10A	
		277VAC	20A	--	--	--	
		240VAC	15A	--	--	--	
		250VAC	40A		40A		
	Ballast	125/240/277VAC	6A	3A	6A	3A	
	Pilot duty	125VAC	800VA	290VA	800VA	290VA	
		125VAC	690VA	--	690VA	--	
		125VAC	800VA	--	800VA	--	
		240VAC	1152VA	768VA	1152VA	768VA	
		277VAC	764VA	--	764VA	--	
	Motor load	125VAC	1HP	1/4HP	1HP	1/4HP	
		240VAC	2HP	1HP	2HP	1HP	
		125VAC	1HP	--	1HP	--	
		125/277VAC	3/4HP	--	3/4HP	--	
	Definite purpose (LRA-loaded rotor) (FLA-full load)	120VAC	82.8LRA, 13.8FLA	--	82.8LRA, 13.8FLA	--	
		125VAC	96LRA, 30FLA	33LRA, 10FLA	60LRA, 20FLA	33LRA, 10FLA	
		125VAC	60LRA, 20FLA	30LRA, 12FLA	60LRA, 20FLA	30LRA, 12FLA	
		125VAC	82.8LRA, 27FLA	--	82.8LRA, 27FLA	--	
		240VAC	80LRA, 30FLA	33LRA, 10FLA	60LRA, 20FLA	33LRA, 10FLA	
		240VAC	41.4LRA, 6.9FLA	--	41.4LRA, 6.9FLA	--	
		277VAC	60LRA, 20FLA	--	60LRA, 20FLA	--	
	Tungsten	125VAC	15A	--	15A	--	
		240VAC	5A	--	5A	3A	
		120VAC	--	3A	--	--	
		240VAC	--	3A	--	--	
	AgSnO <sub>2</sub>	General purpose	125/240VAC	30A	--	--	--

Notes: 1) All values unspecified are at room temperature.

2) Only typical loads are listed above. Other load specifications can be available upon request.

## ORDERING INFORMATION

Type	HF2160	-1A	-12D	E	T	F	(XXX)
Contact arrangement	1A: 1 Form A 1B: 1 Form B 1C: 1 Form C						
Coil voltage	5, 6, 9, 12, 15, 18, 24, 48, 70, 110VDC						
Construction <sup>1)2)</sup>	E: Plastic sealed Nil: Dust protected						
Contact material	T: AgSnO <sub>2</sub>		Nil: AgCdO				
Insulation standard	F: Class F		Nil: Class B				
Customer special code							

- Notes: 1) We recommend dust protected types for a clean environment (free from contaminations like H<sub>2</sub>S, SO<sub>2</sub>, NO<sub>2</sub>, dust, etc.).  
We suggest to choose plastic sealed types and validate it in real application for an unclean environment (with contaminations like H<sub>2</sub>S, SO<sub>2</sub>, NO<sub>2</sub>, dust, etc.).
- 2) Contact is recommended for suitable condition and specifications if water cleaning or surface process is involved in assembling relays on PCB.

## OUTLINE DIMENSIONS, WIRING DIAGRAM AND PC BOARD LAYOUT

Unit: mm

### 1 Form A

Outline Dimensions

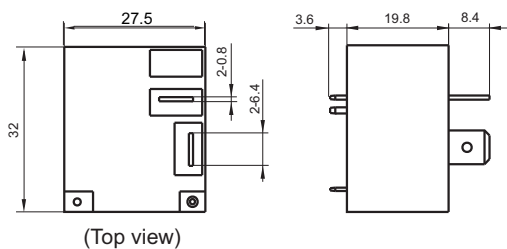

Wiring Diagram

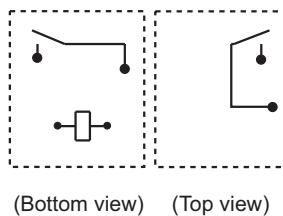

PCB Layout  
(Bottom view)

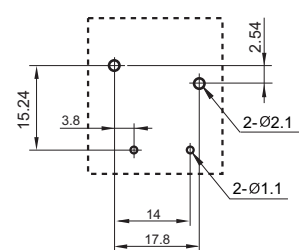

### 1 Form B

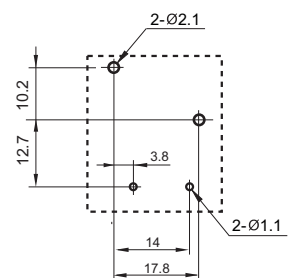
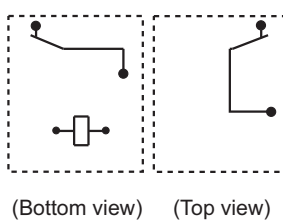
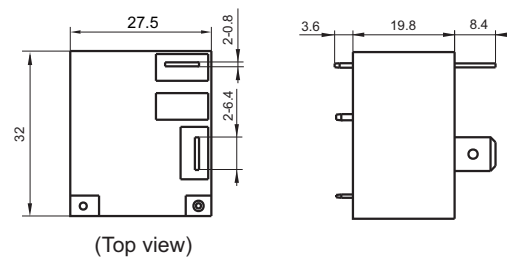

# OUTLINE DIMENSIONS, WIRING DIAGRAM AND PC BOARD LAYOUT

Unit: mm

## 1 Form C

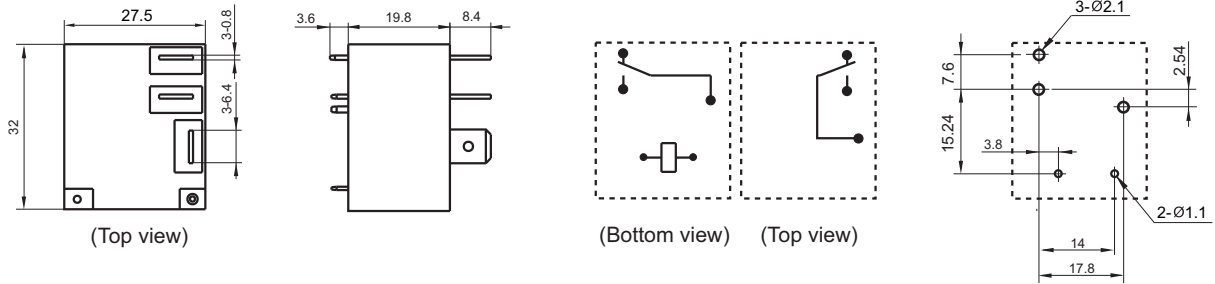

Remark: 1) In case of no tolerance shown in outline dimension: outline dimension  $\leq 1\text{mm}$ , tolerance should be  $\pm 0.2\text{mm}$ ; outline dimension  $> 1\text{mm}$  and  $\leq 5\text{mm}$ , tolerance should be  $\pm 0.3\text{mm}$ ; outline dimension  $> 5\text{mm}$ , tolerance should be  $\pm 0.4\text{mm}$ .  
 2) The tolerance without indicating for PCB layout is always  $\pm 0.1\text{mm}$ .

# CHARACTERISTIC CURVES

MAXIMUM SWITCHING POWER

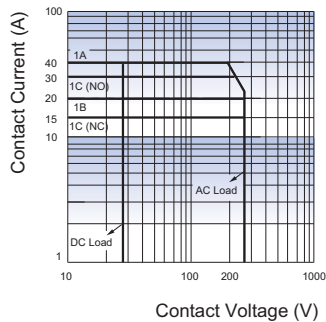

ENDURANCE CURVE

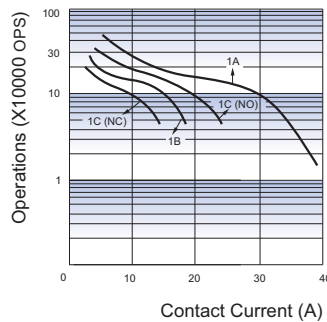

COIL TEMPERATURE RISE

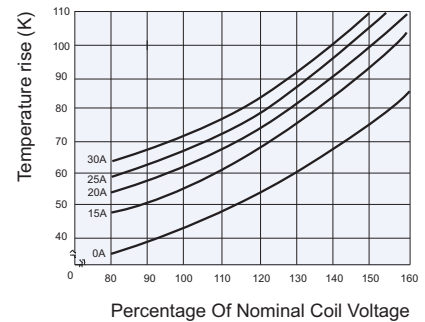

**Test conditions:**  
 Resistive load, AgCdO, Dust protected,  
 Room temp., 1s on 9s off.

### Disclaimer

The specification is for reference only. See to "Terminology and Guidelines" for more information. Specifications subject to change without notice. We could not evaluate all the performance and all the parameters for every possible application. Thus the user should be in a right position to choose the suitable product for their own application. If there is any query, please contact Hongfa for the technical service. However, it is the user's responsibility to determine which product should be used only.

© Xiamen Hongfa Electroacoustic Co., Ltd. All rights of Hongfa are reserved.