

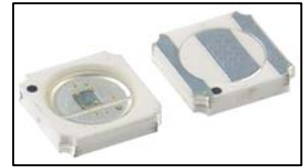

VL390-5050



TECHNICAL DATA

High Power UV LED, SMD 5x5 mm Ceramic

Features

- Zener diode is built in the protective circuit against static electricity
- Low Voltage DC Operated
- High Power Intensity
- Complies with RoHS Directive



Specifications (25°C)

Item	Symbol	Value	Unit
Absolute Maximum Ratings			
DC Forward Current	I_F	350	mA
Peak Pulse Forward Current *	I_{FP}	420	mA
Reverse Voltage	U_R	5	V
Power Dissipation	P_D	1000	mW
Operating Temperature	T_{OP}	-40 ... +85	°C
Storage Temperature	T_{STG}	-40 ... +100	°C
Soldering Temperature (for 5 sec.)	T_{SOL}	260 ± 5	°C

* Note: 1/200 duty cycle, 10 µs pulse width

Item	Symbol	Min.	Typ.	Max.	Unit
Optical Specifications					
CW Output Power * ¹	P_O	70	-	80	mW
Peak Wavelength * ²	λ_P	385	390	395	nm
Viewing Angle	φ		120		deg.
Electrical Specifications					
Forward Current	I_F	-	350	-	mA
Forward Voltage * ³	V_F	3.2	-	4.2	V

* Note:

1. Peak wavelength measurement allowance is ± 2 nm
2. Optical output measurement allowance is ± 10%
3. Forward voltage measurement allowance is ± 0.2 V

Outline Dimensions (Unit: mm, Tolerance: ±0.2 mm)

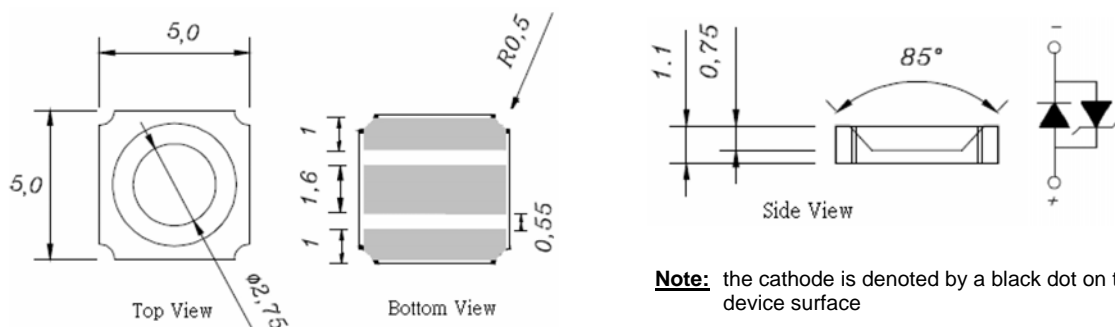

Note: the cathode is denoted by a black dot on the device surface



Typical Performance Curves

Spectral Distribution

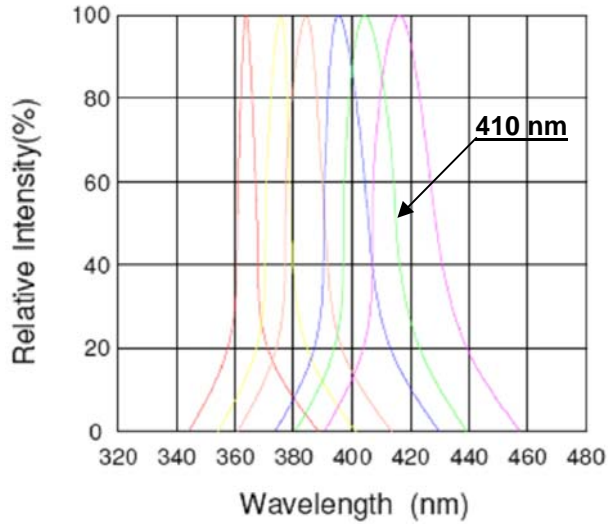

Forward Voltage vs. Forward Current

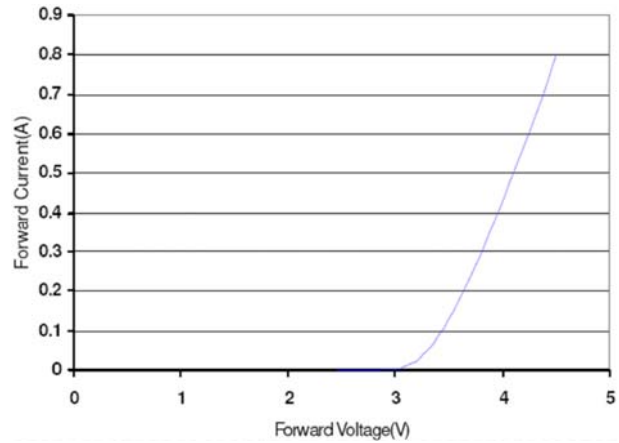

Ambient Temperature vs. Forward Voltage

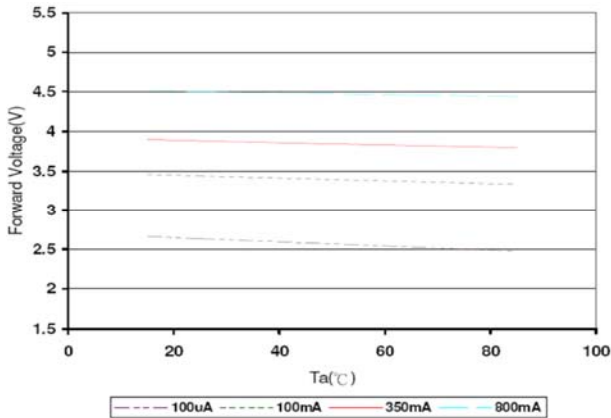

Forward Current vs. Relative Radiance

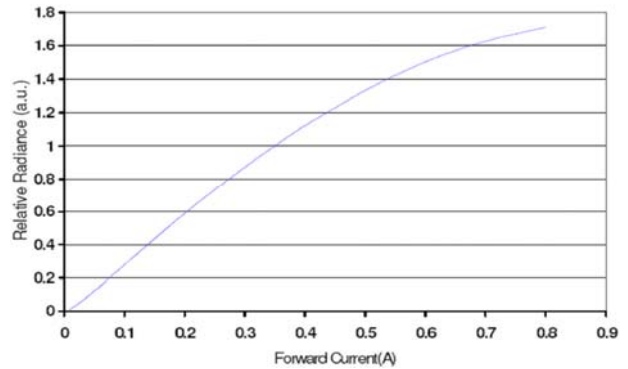

Ambient Temperature vs. Relative Radiance

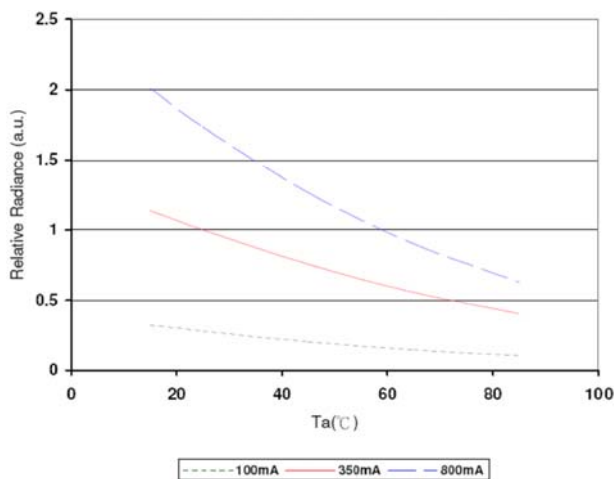

Ambient Temperature vs. Peak Wavelength

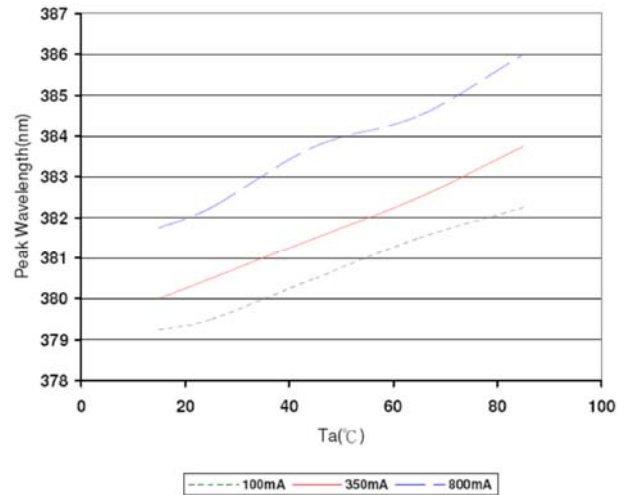



Reliability

No.	Test Item	Standard Test Methode	Test Conditions	Note	Sample	Pass
1	Steady State Operating Life	Internal Ref.	$I_F=350\text{mA}$	1000 Hr	20	OK
2	Soldering Test	JESD22-B102-C	260°C max	2 Times	20	OK
3	Reflow Test	JESD22-B102-C	260°C max	2 Times	20	OK
4	Thermal Shock	JESD22-A106-A	-40°C ... +85°C	84 Cycles	20	OK
5	Temperature Cycle	JESD22-A104-A	-35°C ... +75°C	168 Cycles	20	OK
6	High Temperature Storage	JESD22-A103-A	Tstg=85°C	1000 Hr	20	OK
7	Low Temperature Storage	Internal Ref.	Tstg=-40°C	1000 Hr	20	OK
8	High Temperature High Humidity	JESD22-A101-B	Ta=85°C, RH=85%	1000 Hr	20	OK
9	On-Off Test	Internal Ref.	2sec ON, 2sec OFF	100000 cycle	20	OK
10	ESD Test	JEITA ED-4701 300 304	R=1.5kΩ, C=100pF Test Voltage = 2KV	3 times Negative/Positive	20	OK

Conclusions:

1. The reliability tests were designed to evaluate both package integrity as well as workability of product performance over time.
2. All samples have done well by completed test required and passed all the qualification criteria with zero failure. From design standpoint, this package is robust enough to meet its data sheet conditions.
3. Based on the good result shown on the above test, this product is qualified and released for market.

Precaution for Use

1. Cautions

- This device is a UV LED, which radiates UV light during operation.
- DO NOT look directly into the UV light or look through the optical system. To prevent an adequate exposure of UV radiation, wear UV protective glasses.

2. Surface Mount Condition

In automatic mounting of the SMD LEDs on printed circuit boards, any bending, expanding and pulling forces or shock against the SMD LEDs should be kept min. to prevent them from electrical failures and mechanical damages of the devices.



3. Reflow Soldering

- Soldering of the SMD LEDs should conform to soldering condition in the individual specifications.
- SMD LEDs are designed for Reflow Soldering.
- In the reflow soldering, too high temperature and too large temperature gradient such as rapid heating/cooling may cause electrical & optical failures and damages of the devices.
- We cannot guarantee the LEDs after they have been assembled using the solder dipping method.
- After LEDs have been soldered, repairs should not be done. As repair is unavoidable, a double-head soldering iron should be used. It should be confirmed beforehand whether the characteristics of the LEDs will be damaged by repairing or not.
- Reflow soldering should not be done more than two times.

Lead Solder

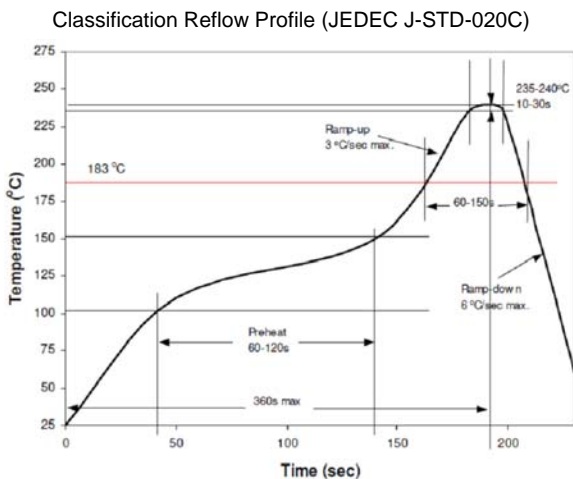

Lead-Free Solder

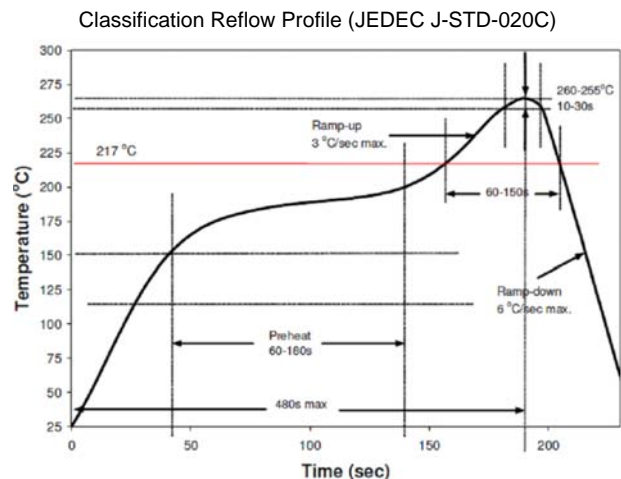

Manual Soldering conditions

1. Lead Solder: max. 300°C for max. 3sec, and only one time.
2. Lead-free Solder: max. 350°C for max. 3sec, and only one time.

- Recommended Soldering Pattern:

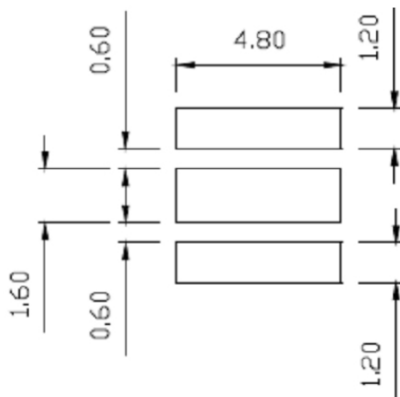



4. Static Electricity

- The LEDs are very sensitive to Static Electricity and surge voltage. So it is recommended that a wrist band or an anti-electrostatic glove be used when handling the LEDs.
- All devices, equipment and machinery must be grounded properly. It is recommended that precautions should be taken against surge voltage to the equipment that mounts the LEDs.

5. Heat Generation

- The powered LEDs generate heat. Heat dissipation should be considered in the application design to avoid the environmental conditions for operation in excess of the absolute maximum ratings.